

ELECTRONIC CASH REGISTER

SE-S300

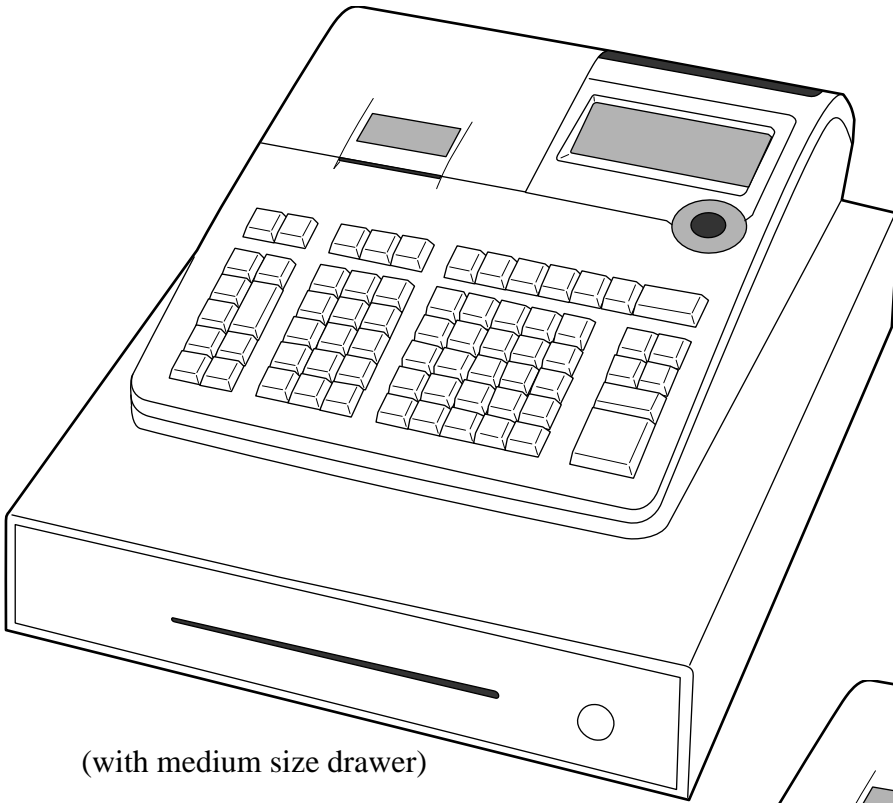

(with medium size drawer)

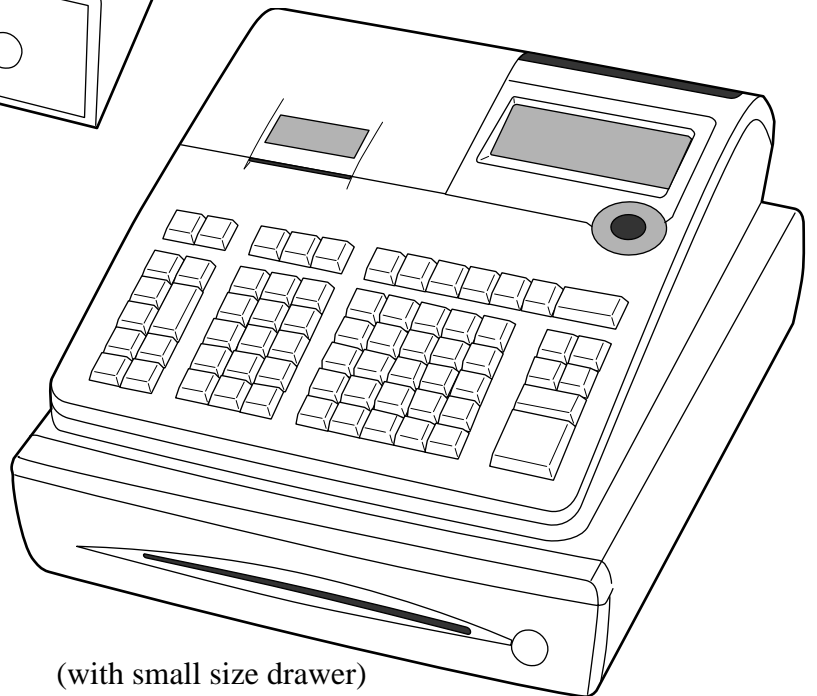

(with small size drawer)

USER'S MANUAL

Eu Di U.K.

CASIO[®]

Introduction & Contents

Important!

Your new cash register has been carefully tested before shipment to ensure proper operation. Safety devices eliminate worries about breakdowns resulting from operator errors or improper handling. In order to ensure years of trouble-free operation, however, the following points should be noted when handling the cash register.

Do not locate the cash register where it will be subjected to direct sunlight, high humidity, splashing with water or other liquids, or high temperature (such as near a heater).

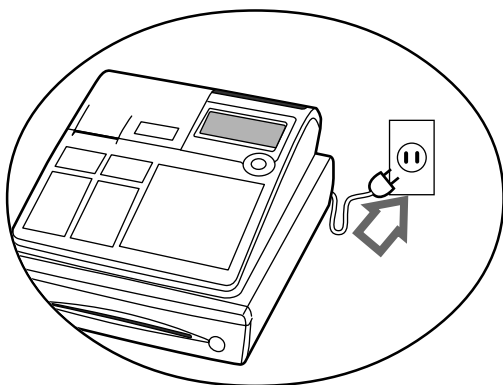
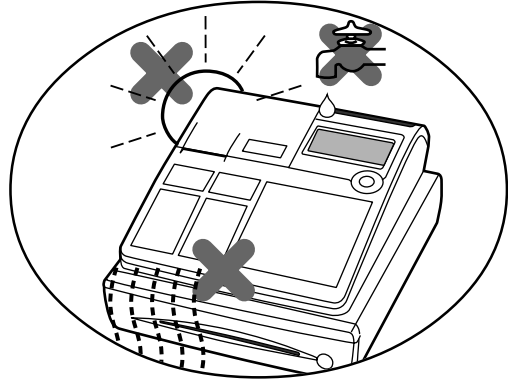

Be sure to check the sticker on the side of the cash register to make sure that its voltage matches that of the power supply in the area.

Never operate the cash register while your hands are wet.

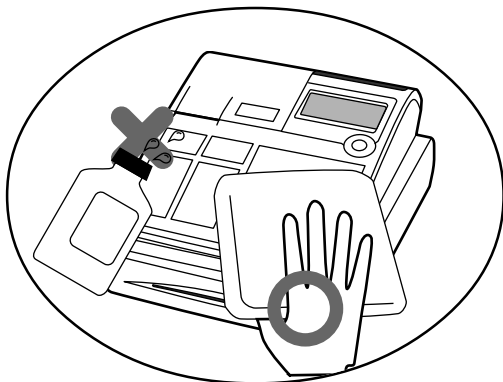
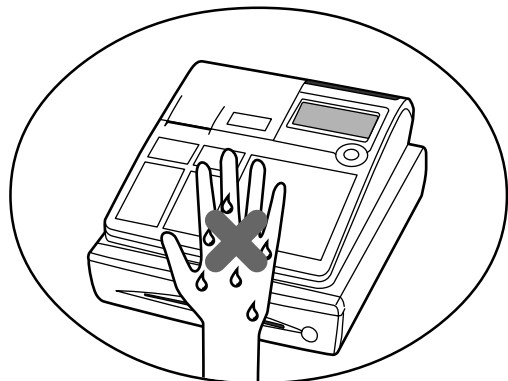

Use a soft, dry cloth to clean the exterior of the cash register. Never use benzene, thinner, or any other volatile agent.

Never try to open the cash register or attempt your own repairs. Take the cash register to your authorized CASIO dealer for repairs.

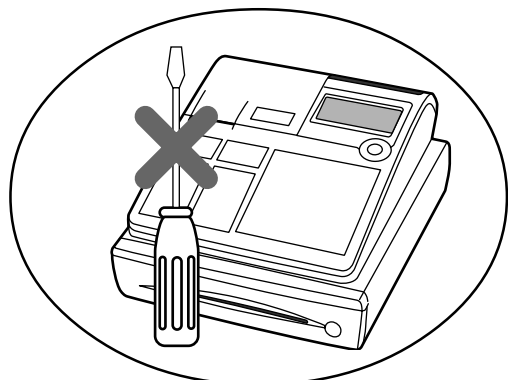

Welcome to CASIO Cash Register!

Congratulations upon your selection of a CASIO Electronic Cash Register, which is designed to provide years of reliable operation.

Operation of a CASIO cash register is simple enough to be mastered without special training.

Everything you need to know is included in this manual, so keep it on hand for reference.

Consult your CASIO dealer if you have any questions about points not specifically covered in this manual.



Manufacturer:

CASIO COMPUTER CO., LTD.

6-2, Hon-machi 1-chome, Shibuya-ku, Tokyo 151-8543, Japan

Representative within the European Union:

CASIO EUROPE GmbH

Bornbarch 10, 22848 Norderstedt Germany

Please keep all information for future reference.

The main plug on this equipment must be used to disconnect mains power.

Please ensure that the socket outlet is installed near the equipment and shall be easily accessible.



This mark applies in EU countries only.

Introduction & Contents

Safety Precautions

- To use this product safely and correctly, read this manual thoroughly and operate as instructed.
After reading this guide, keep it close at hand for easy reference.
Please keep all informations for future reference.
- Always observe the warnings and cautions indicated on the product.

About the icons

In this guide various icons are used to highlight safe operation of this product and to prevent injury to the operator and other personnel and also to prevent damage to property and this product. The icons and definitions are given below.



Indicates that there is a risk of severe injury or death if used incorrectly.



Indicates that injury or damage may result if used incorrectly.

Icon examples

To bring attention to risks and possible damage, the following types of icons are used.



The \triangle symbol indicates that it includes some symbol for attracting attention (including warning). In this triangle the actual type of precautions to be taken (electric shock, in this case) is indicated.



The \otimes symbol indicates a prohibited action. In this symbol the actual type of prohibited actions (disassembly, in this case) will be indicated.



The \bullet symbol indicates a restriction. In this symbol the type of actual restriction (removal of the power plug from an outlet, in this case) is indicated.

Warning!

Handling the register



Should the register malfunction, start to emit smoke or a strange odor, or otherwise behave abnormally, immediately shut down the power and unplug the AC plug from the power outlet. Continued use creates the danger of fire and electric shock.

- Contact CASIO service representative.



Do not place containers of liquids near the register and do not allow any foreign matter to get into it. Should water or other foreign matter get into the register, immediately shut down the power and unplug the AC plug from the power outlet. Continued use creates the danger of shorting, fire and electric shock.

- Contact CASIO service representative.



Should you drop the register and damage it, immediately shut down the power and unplug the AC plug from the power outlet. Continued use creates the danger of shorting, fire and electric shock.

- Attempting to repair the register yourself is extremely dangerous. Contact CASIO service representative.



Never try to take the register apart or modify it in any way. High-voltage components inside the register create the danger of fire and electric shock.

- Contact CASIO service representative for all repair and maintenance.
-

⚠ Warning!

Power plug and AC outlet



Use only a proper AC electric outlet (100V~240V) . Use of an outlet with a different voltage from the rating creates the danger of malfunction, fire, and electric shock. Overloading an electric outlet creates the danger of overheating and fire.



Make sure the power plug is inserted as far as it will go. Loose plugs create the danger of electric shock, overheating, and fire.

- Do not use the register if the plug is damaged. Never connect to a power outlet that is loose.



Use a dry cloth to periodically wipe off any dust built up on the prongs of the plug. Humidity can cause poor insulation and create the danger of electric shock and fire if dust stays on the prongs.

Never use detergent to clean the power cord, especially the plug and jack.



Do not allow the power cord or plug to become damaged, and never try to modify them in any way. Continued use of a damaged power cord can cause deterioration of the insulation, exposure of internal wiring, and shorting, which creates the danger of electric shock and fire.

- Contact CASIO service representative whenever the power cord or plug requires repair or maintenance.
-

⚠ Caution!



Do not place the register on an unstable or uneven surface. Doing so can cause the register — especially when the drawer is open — to fall, creating the danger of malfunction, fire, and electric shock.



Do not place the register in the following areas.

- Areas where the register will be subject to large amounts of humidity or dust, or directly exposed to hot or cold air.
- Areas exposed to direct sunlight, in a close motor vehicle, or any other area subject to very high temperatures.

The above conditions can cause malfunction, which creates the danger of fire.



Do not overlay bend the power cord, do not allow it to be caught between desks or other furniture, and never place heavy objects on top of the power cord. Doing so can cause shorting or breaking of the power cord, creating the danger of fire and electric shock.



Be sure to grasp the plug when unplugging the power cord from the wall outlet. Pulling on the cord can damage it, break the wiring, or cause short, creating the danger of fire and electric shock.



Never touch the plug while your hands are wet. Doing so creates the danger of electric shock. Pulling on the cord can damage it, break the wiring, or cause short, creating the danger of fire and electric shock.

Never touch the printer head, platen and cutter.

Introduction & Contents

Introduction & Contents	2
Getting Started	10
1. Load the memory protection batteries and Paper rolls	10
2. Install receipt / journal paper.	11
3. Plug the cash register into a wall outlet.	13
4. Insert the mode key marked "PGM" into the mode switch.	13
5. Turn the mode switch to the "PGM" position.	13
6. Set the date.	13
7. Set the time.	13
8. Tax table programming	14
9. Select printouts and watermark on receipt.	16
10. For Australian GST	16
11. Department unit price programming	17
12. PLU unit price programming	17
13. Discount rate programming	17
14. Issuing daily reset report	17
15. Advanced operations and Setups	18
16. Issuing reports	18
17. Troubleshooting	18
Introducing the Register	20
General guide	20
Roll paper	20
Mode key	20
Drawer	21
Mode switch	21
How to set the Pop-up display	21
Drawer lock / Drawer key	21
Magnetic plate	21
Display	22
Display panel	22
Main display	22
Customer display	22
Keyboard	24
Basic Operations and Setups	26
How to read the printouts	26
How to use your cash register	27
Before business hours	28
Checking the time and date	28
To display and clear the date/time	28
Preparing coins for change	28
Preparing and using department keys	29
Registering department keys	29
Programming department keys	31
To program a unit price for each department	31
To program the tax calculation status for each department	31
To program high amount limit for each department	31
Registering department keys by programming data	32
Preset price	32
Preset tax status	32
Locking out high amount limitation	32
Preparing and using PLUs	33
Programming PLUs	33
To program a unit price for each PLU	33
To program tax calculation status for each PLU	33

Registering PLUs	34
Preparing and using discounts	36
Programming discounts	36
Registering discounts	36
Discount for items and subtotals	36
Preparing and using reductions	37
Programming for reductions	37
To program preset reduction amount	37
Registering reductions	37
Reduction for items and subtotal	37
Registering credit and check payments	38
Check	38
Charge	38
Credit	38
Mixed tender (cash and check)	38
Registering both the Euro and local currency	39
Registering returned goods in the REG mode	40
Registering returned goods in the RF mode	40
Registering money received on account	41
Registering money paid out	41
No sale registration	41
Making corrections in a registration	42
To correct an item you input but not yet registered	42
To correct an item you input and registered	43
To cancel all items in a transaction	44
Printing the daily sales reset report	45
Advanced Operations	46
Using clerk functions	46
Enable clerk feature	46
Assigning a clerk	46
Clerk number key	46
Single item cash sales	47
Currency exchange function	48
Registering foreign currency	48
Full amount tender in foreign currency	48
Partial tender in a foreign currency	49
Premium	50
Coupon	50
VAT breakdown printing	51
Programming department / PLU descriptors and preset messages in the list	52
How to choose and set the department / PLU descriptors in the list	52
How to choose and set the preset receipt message and graphic logo in the list	52
Preset message and graphic print sample	52
Character manual input	53
Entering characters	53
Using character keyboard	53
Entering characters by multi tapping	54
Programming descriptors and messages by entering characters	55
Programming PLU descriptor	55
Programming department / function key descriptor	56
Function key	56
Department key	56
Programming message	57
Receipt message	57
Programming Clerk name	57
Clerk name	57

Introduction & Contents

Programming other descriptors	58
Report descriptor	58
Grand total, special character	59
Report title	59
Machine feature program	60
General control program	60
Programming procedure	60
Program data (by address code)	60
Address code 02 (machine number)	60
Address code 03 (consecutive number)	60
Address code 04 (tax system, rounding)	60
Address code 05 (print control for receipt)	61
Address code 06 (calculation & operation control)	61
Address code 08 (print control for fixed total report)	62
Address code 10 (print control for taxable amount)	62
Address code 14 (currency exchange control)	63
Address code 15 (print control for reports)	63
Address code 16 (print control for grand total)	63
Address code 17 (print control)	64
Address code 19 (receipt control)	64
Address code 21 (message control)	64
Address code 25 (entry restriction)	64
Address code 27 (clerk control)	64
Address code 28 (Euro 1)	65
Address code 29 (Euro 2)	65
Address code 30 (thermal printer control)	66
Address code 34 (backlight control)	66
Key function program	68
Department key/PLU program (Batch feature programming)	68
Programming procedure	68
Program data	68
Department key/PLU program (Individual feature programming)	69
Programming procedure	69
Program data (by address code)	70
Transaction key program	71
Programming procedure	71
Program data	71
Clerk program	74
Clerk number, check number programming	74
Clerk other programming	74
Printing read/reset reports	76
To print the individual department, PLU read report	76
To print daily read reports (except electronic journal)	77
To print electronic journal read report	77
To print daily reset reports	78
Read / reset report sample	79
To print the periodic 1/2 sales read/reset reports	82
Reading the cash register's program	84
To print unit price/rate program (except PLU)	84
To print key descriptor, name, message program (except PLU)	84
To print the machine program (except PLU)	85
To print the PLU unit price	86
To print the PLU descriptor	86
To print the PLU program	86

Troubleshooting	88
When an error occurs	88
When the * sign appears on the display	89
When the register does not operate at all	90
Clearing a machine lock up	90
In case of power failure	91
When the L sign appears on the display	91
User Maintenance and Options	92
To replace journal paper	92
To replace receipt paper	93
Options	93
Specifications	94
Index	95

Getting Started

This chapter shows how to setup the cash register and get it ready to operate. Please read this chapter even if you have used a cash register before.

1. Load the memory protection batteries and Paper rolls

Load the two memory protection batteries

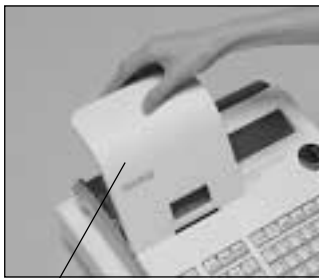

printer cover

1. Remove the printer cover.



2. Remove the battery compartment cover.

battery compartment cover



3. Note the (+) and (-) markings in the battery compartment. Load a set of two new alkaline batteries so that their positive (+) and negative (-) ends are facing as indicated by the markings.



4. Replace the battery compartment cover.



5. Replace the printer cover.

No battery is included in the accessories.

Important!

These batteries protect information stored in your cash register's memory when there is a power failure or when you unplug the cash register. Be sure to install these batteries.

WARNING!

- Never try to recharge the batteries supplied with the unit.
- Do not expose batteries to direct heat, let them become shorted or try to take them apart.

Keep batteries out of the reach of small children. If your child should swallow a battery, consult a physician immediately.

2. Install receipt / journal paper.

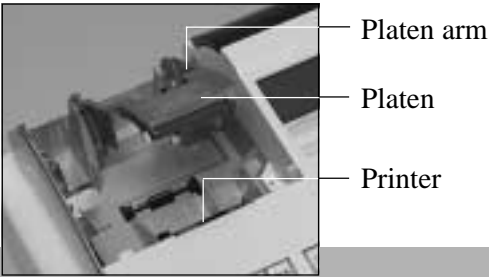

Important!

Take away the head protection sheet from the printer and close the platen arm.

Caution! (in handling the thermal paper)

- Never touch the printer head and the platen.
- Unpack the thermal paper just before your use.
- Avoid heat/direct sunlight.
- Avoid dusty and humid places for storage.
- Do not scratch the paper.
- Do not keep the printed paper under the following circumstances:
High humidity and temperature/direct sunlight/contact with glue, thinner or a rubber eraser.

To install receipt paper



Step 1
Remove the printer cover.



Step 4
Put the leading end of the paper over the printer.



Step 2
Open the platen arm.



Step 5
Close the platen arm slowly until it locks steadily.



Step 3
Ensuring the paper is being fed from the bottom of the roll, lower the roll into the space behind the printer.



Complete
Replace the printer cover, passing the leading end of the paper through the cutter slot. Tear off the excess paper.

To install journal paper



Step 1

Remove the printer cover.



Step 2

Open the platen arm.



Step 7

Slide the leading end of the paper into the groove on the spindle of the take-up reel and wind it onto the reel two or three turns.



Step 3

Ensuring the paper is being fed from the bottom of the roll, lower the roll into the space behind the printer.



Step 8

Replace the paper guide of the take-up reel.



Step 4

Put the leading end of the paper over the printer.



Step 9

Place the take-up reel into place behind the printer, above the roll paper.



Step 5

Close the platen arm slowly until it locks steadily.



Step 10

Press the **FEED** key to take up any slack in the paper.

During machine installation, press the **FEED** key after power on.



Step 6

Remove the paper guide of the take-up reel.



Complete

Replace the printer cover.

3. Plug the cash register into a wall outlet.

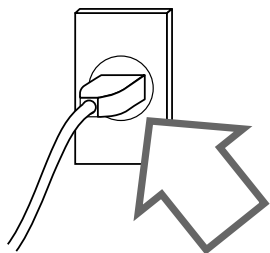

Be sure to check the sticker (rating plate) on the side of the cash register to make sure that its voltage matches that of the power supply in your area.

4. Insert the mode key marked “PGM” into the mode switch.

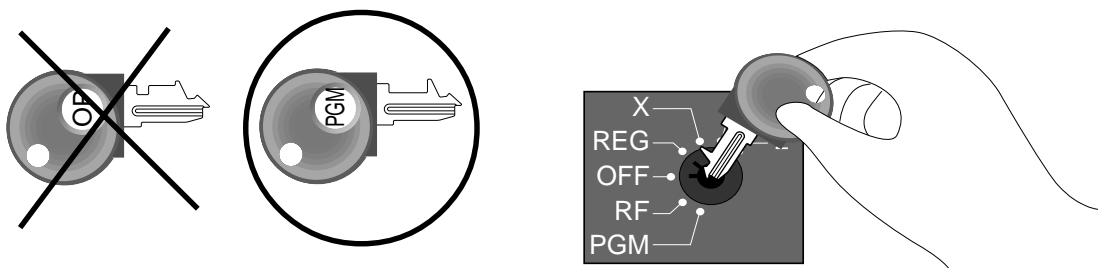

5. Turn the mode switch to the “PGM” position.

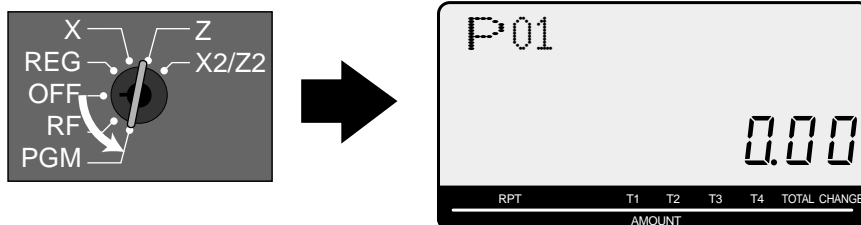

When the display shows “Low battery”, load memory protection batteries (refer to page 10).

6. Set the date.

1. Enter current date in year - month - day order, and press the <X/DATE TIME>

Example: 15, June, 2008 ⇨ **0 8 0 6 1 5**

2. Press <C> key.

Example:

7. Set the time.

1. Enter current time in 24 hour system, and press the <X/DATE TIME>

Example: 08:30 a.m. ⇨ **0 8 3 0** (9:45 p.m. ⇨ **2 1 4 5**)

2. Press <C> key.

Example:

8. Tax table programming

This cash register is capable of automatically calculating up to four different sales taxes. The sales tax calculations are based on rates, so you must tell the cash register the rates, the type of tax (add-in or add-on). Note that special rounding methods (next page) are also available to meet certain local tax requirements.

Important!

After you program the tax calculations, you also have to individually specify which departments (page 31) and PLUs (page 33) are to be taxed.

Programming tax calculations

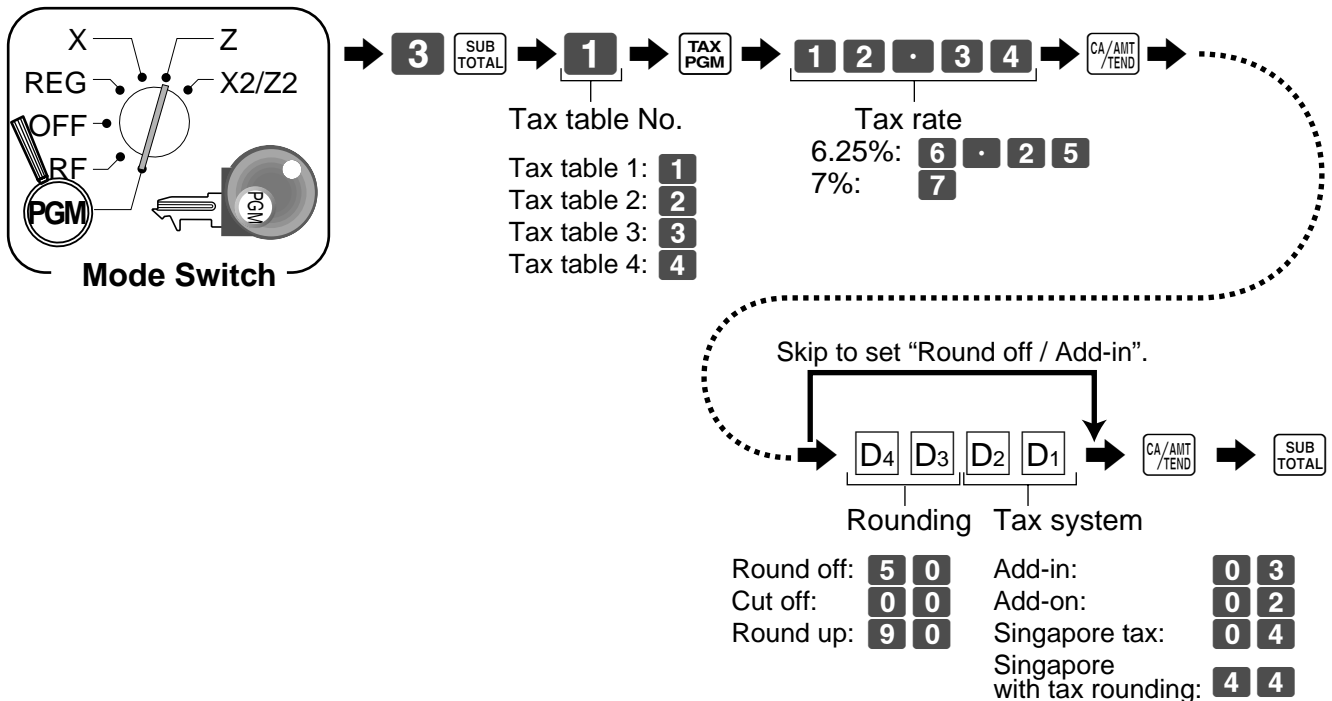

8. Tax table programming (about special rounding)

Besides cut off, round off and round up, you can also specify “special rounding” for subtotals and totals or changes. Special rounding converts the right-most digit(s) of an amount to “0” or “5” (or “00”, “25”, “50”, “75”) to comply with the requirements of certain areas.

Programming special rounding

See the list below and select the rounding which you require.

Programming procedure



IF 1 rounding	
Last 1 digit of subtotal	Result
0 ~ 2	0
3 ~ 7	5
8 ~ 9	10

D₁₀ ~ D₁ = 1 0 0 0 0 0 0 0 0 0 0 0

Norwegian rounding	
Last 1 digit of subtotal	Result
00 ~ 24	0
25 ~ 74	50
75 ~ 99	100

D₁₀ ~ D₁ = 4 0 0 0 0 0 0 0 0 0 0 0

Australian rounding	
Last 1 digit of subtotal/cash change	Result
0 ~ 2	0
3 ~ 7	5
8 ~ 9	10

D₁₀ ~ D₁ = 7 0 0 0 0 0 0 0 0 0 0 0

IF 2 rounding	
Last 1 digit of subtotal	Result
0 ~ 4	0
5 ~ 9	10

D₁₀ ~ D₁ = 2 0 0 0 0 0 0 0 0 0 0 0

Singaporean rounding	
Last 1 digit of item, %+, %- registration	Result
0 ~ 2	0
3 ~ 7	5
8 ~ 9	10

D₁₀ ~ D₁ = 5 3 0 0 0 0 0 0 0 0 0 0

South African rounding	
Last 1 digit of subtotal	Result
0 ~ 4	0
5 ~ 9	5

D₁₀ ~ D₁ = 8 0 0 0 0 0 0 0 0 0 0 0

Danish rounding	
Last 2 digit of subtotal/cash change	Result
00 ~ 12	00
13 ~ 37	25
38 ~ 62	50
63 ~ 87	75
88 ~ 99	100

D₁₀ ~ D₁ = 3 0 0 0 0 0 0 0 0 0 0 0

Finnish rounding	
Last 2 digit of subtotal/cash change	Result
0 ~ 2	0
3 ~ 7	5
8 ~ 9	10

D₁₀ ~ D₁ = 6 0 0 0 0 0 0 0 0 0 0 0

New Zealander (A) rounding	
Last 1 digit of subtotal/cash change	Result
0 ~ 4	0
5 ~ 9	10

D₁₀ ~ D₁ = 9 0 0 0 0 0 0 0 0 0 0 0

New Zealander (B) rounding	
Last 1 digit of subtotal/cash change	Result
0 ~ 5	0
6 ~ 9	10

D₁₀ ~ D₁ = 9 0 0 0 0 0 0 0 0 0 0 1

- Partial tenders (payments): for Danisn Rounding

No rounding is performed for the amount of tendered nor for the change amount due when the customer makes a partial tender. When a partial tender results in a remaining balance within the range of 1 through 12, the transaction is finalized as if there was no remaining balance.

- Display and printing of subtotals: for Danish and Australian Rounding

When you press the **SUB TOTAL** key, the rounded subtotal is printed and shown on the display. If the cash register is also set up to apply an add-on tax rate, the add-on tax amount is also included in the subtotal that is printed and displayed.

Important!

When you are using Danish rounding, you can use the **CA/AMT/TEND** key to register tendered amount in which the last (right-most) digits are 00, 25, 50 or 75. This restriction does not apply to the **CH** and **CHK/TEND** keys.

9. Select printouts and watermark on receipt.

Turn the mode switch to “PGM”, enter <0>, <1> or <10>, and press the <CH> , <ST>

Example: issue receipt (with no watermark)	⇒	0	CH	SUB TOTAL
issue receipt (with watermark)	⇒	1	CH	SUB TOTAL
print journal	⇒	1 0	CH	SUB TOTAL

Note !

If you need journal and are sometimes required receipts by customers, select “issue receipt”. After business hours, issue the electronic journal report.

10. For Australian GST

1. Turn mode switch to X mode.
2. Enter 01012001, press <ST>.
3. Press <CA>. (If you want to cancel this procedure, press <ST> instead of <CA>.)

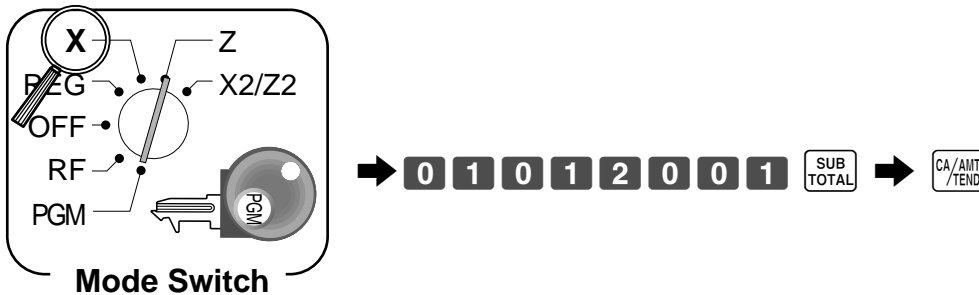

After completion of this procedure, the “GST system was changed” message was printed on receipt and;

- ① Tax symbol (*) is printed.
- ② Taxable amount is skipped.
- ③ “GST INCLUDED” is set to the TX1 descriptor.
- ④ “TAXABLE AMT” is set to the TA1 descriptor.
- ⑤ Total line is printed even in direct (cash) sale.
- ⑥ Australian rounding is set.
- ⑦ “\$” is set to the monetary symbol.
- ⑧ Print “MOF message” on receipt.
- ⑨ Tax (10% tax rate, add-in tax, fraction round off) is set to the tax table 1.
No data is set to other tax tables.
- ⑩ The taxable amount and tax amount except TA1/TX1 are not printed on report.
- ⑪ Restriction (to 0, 5) on last amount digit of cash sales, received on account, paid out, and money declaration.

NOTE:

After completion of register programming, enter **6 2 0 0** and **SUB TOTAL** in the PGM 7 mode (PGM mode ⇒ **7** **SUB TOTAL**) to backup the program data into the internal non-volatile memory.

(This operation takes about 30 seconds.)

11. Department unit price programming

Maximum 6-digit unit price can be set to the department.

Refer to page-32.

Tax calculation status can be set to the department.

Refer to page-32.

12. PLU unit price programming

Maximum 6-digit unit price can be set to the PLU.

Refer to page-33.

Tax calculation status can be set to the PLU.

Refer to page-33.

13. Discount rate programming

0.01 - 99.99% rate can be set to the Discount key.

Refer to page-36.

Tax calculation status can be set to the Discount key.

Refer to page-36.

14. Issuing daily reset report

After business hours, issue daily reset report.

Refer to page-45.

15. Advanced operations and Setups

Using clerk functions	46
Single item cash sales	47
Currency exchange function	48
Premium	50
Coupon	50
VAT breakdown printing	51
Department / PLU name selection / set	52
Preset message /graphic selection / set	52
Character manual input	53
Machine feature program	60
Key function program	68

16. Issuing reports

Individual item read report	76
Daily read report	77
PLU report	77
Monthly report	77
Hourly report	77
Group report	77
Flash report	77
Electronic journal report	77
Daily reset report	78
Periodic sales report	79
Program read report	84

17. Troubleshooting

E sign appears	88
* sign appears	89
Drawer does not open	89
L sign appears	91
To replace receipt / journal paper	92, 93



Introducing the Register

General guide

This part of the manual introduces you to the cash register and provides a general explanation of its various parts.

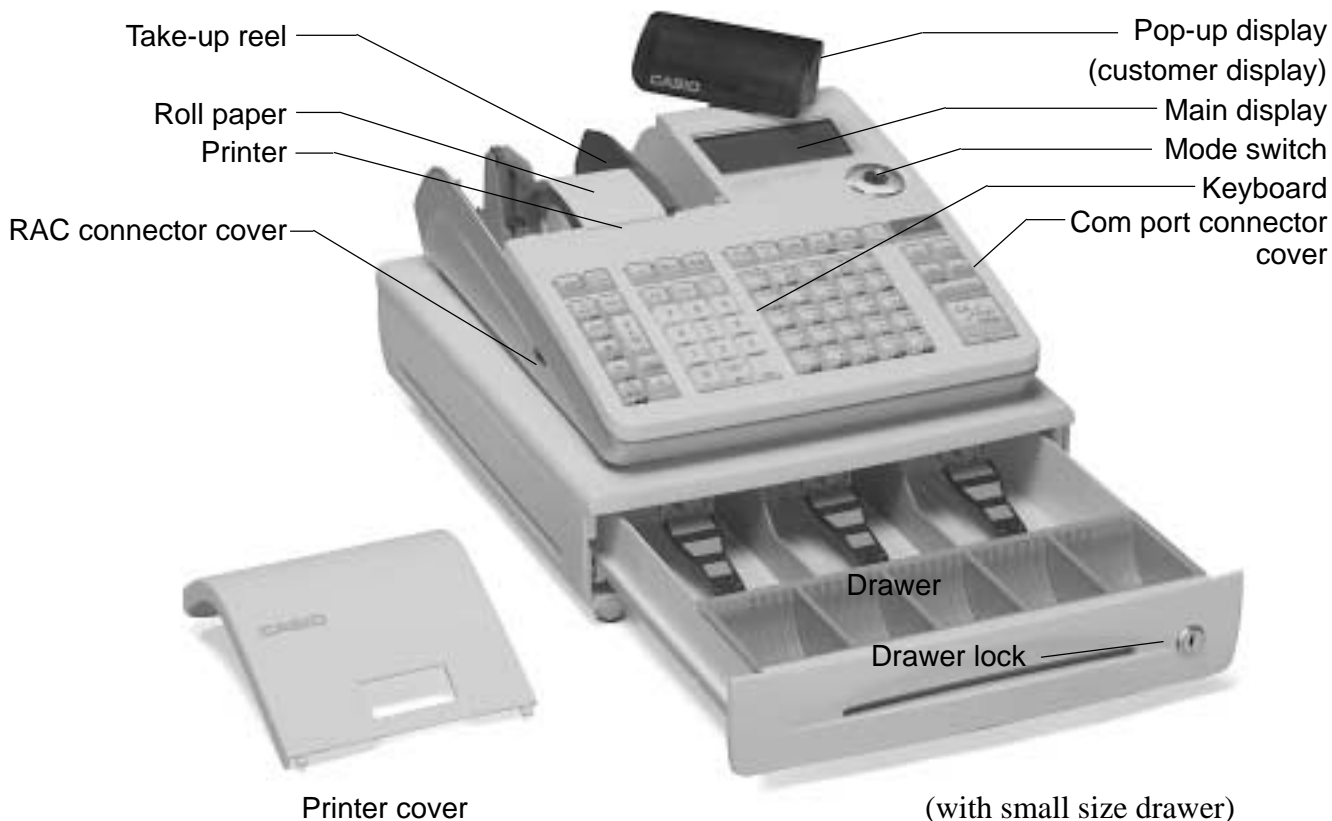

Roll paper

You can use the roll paper to print receipts and a journal (page 11 ~ 12).

Mode key

There are two types of mode keys: the program key (marked “PGM”) and the operator key (marked “OP”). The program key can be used to set the mode switch to any position, while the operator key can select the **REG** and **OFF** position.

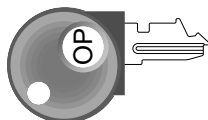

Operator key

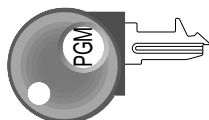

Program key

Drawer

The drawer opens automatically whenever you finalize a registration and whenever you issue a read or reset report. The drawer will not open if it is locked with the drawer key.

Drawer lock / Drawer key

Use the drawer key to lock and unlock the drawer.



Drawer key

Magnetic plate

Use this plate for tacking the notes received from customer.

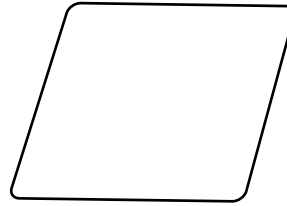

Mode switch

Use the mode keys to change the position of the mode switch and select the mode you want to use.

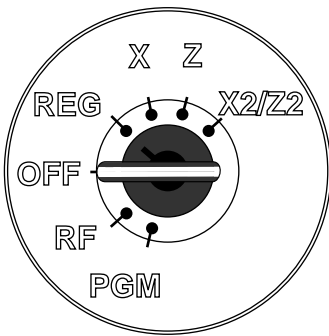

Mode Switch	Mode Name	Description
X2/Z2	Periodic sale read/reset	Used to obtain periodic sales reports without resetting total data or while resetting all total data.
Z	Daily sales reset	Used to obtain daily reports while resetting (clearing) all total data.
X	Daily sales read	Used to obtain daily reports without resetting (clearing) all total data.
REG	Register	Used for normal registration.
OFF	Stand-by	Cash register standing by.
RF	Refund	Used for registering refund transaction.
PGM	Program	Used for cash register programming.

How to set the Pop-up display

1. Lift the unit until it stops.

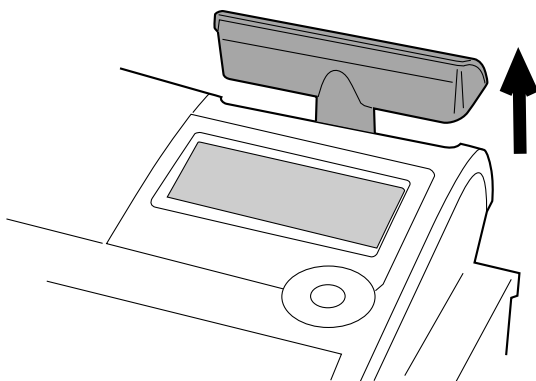

2. Rotate the unit.

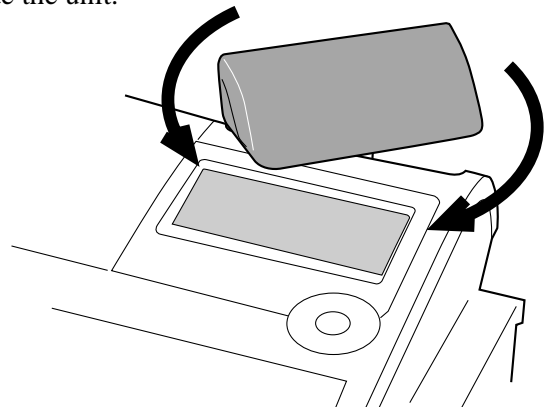

Introducing the Register

Display

Display panel

Main display

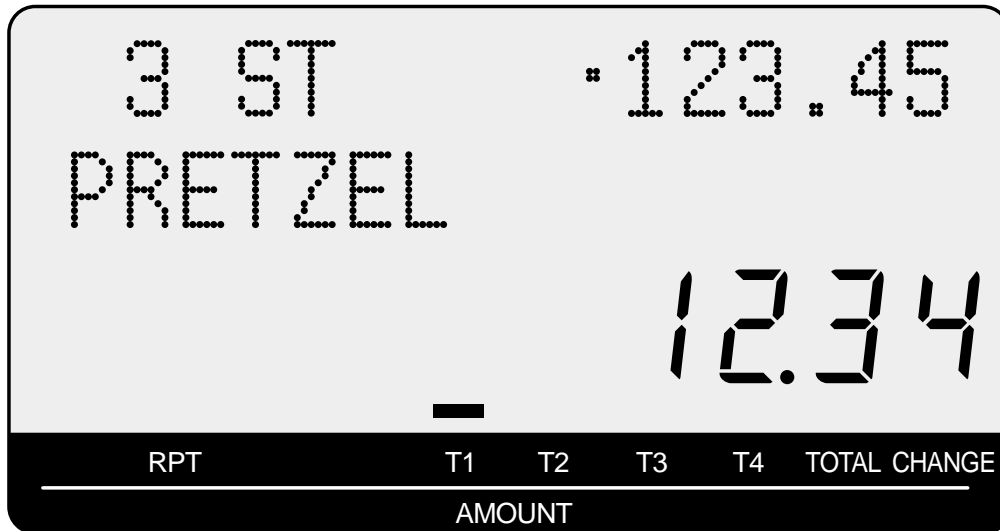

Customer display

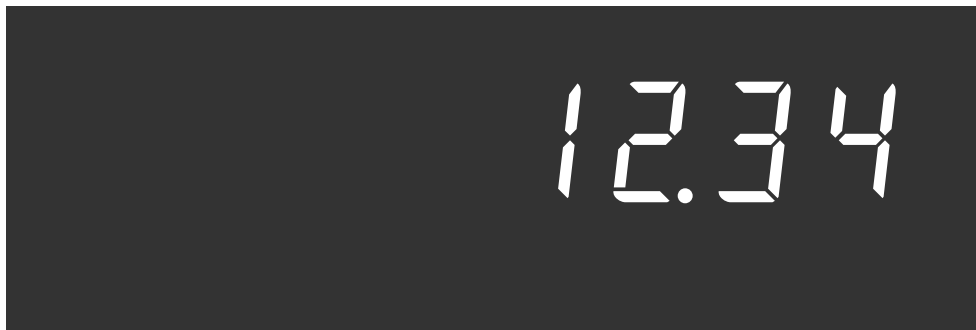

Displays

Main Display

(alphanumeric + numeric display)

Pop-up (customer) display

(numeric display)

Item registration (by department/PLU)

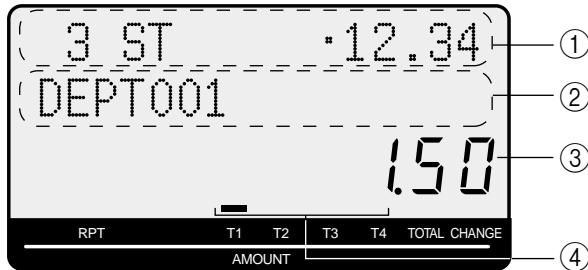

Repeat registration

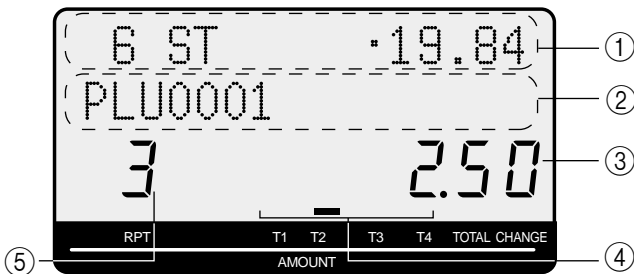

Totalize operation

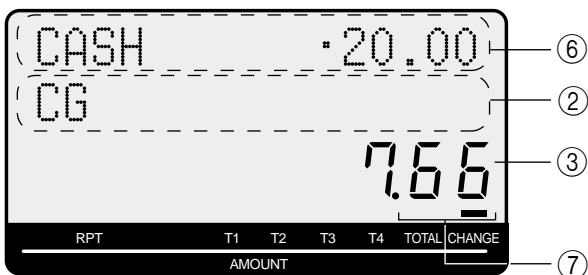

① Item count and subtotal

This part of the display shows item sold count and subtotal.

② Item / Key / Change descriptor

When you register an item or key, the item / key / change descriptor appears here.

Mode descriptor is also displayed here.

③ Amount / Quantity

This part of the display shows monetary amounts. It also can be used to show the current time. (The current date is shown in the alphanumeric display.)

④ Taxable sales status indicators

When you register a taxable item, the corresponding indicator is lit.

⑤ Number of repeats

Anytime you perform a repeat registration (page 29, 34), the number of repeats appears here.

Note that only one digit is displayed for the number of repeats. This means that a "5" could mean 5, 15 or even 25 repeats.

⑥ Tendered amount

When the tender operation is made, the entered value appears here.

⑦ Total / Change indicators

When the TOTAL indicator is lit, the displayed value is monetary total or subtotal amount.

When the CHANGE indicator is lit, the displayed value is the change due.

Introducing the Register

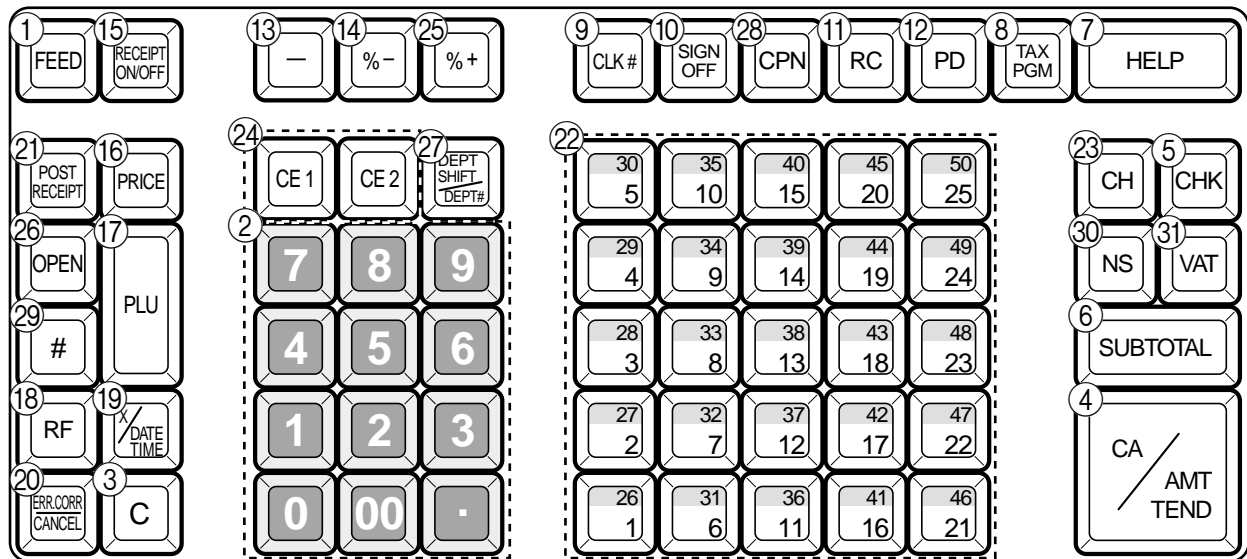

Keyboard





- ① **Paper feed key** FEED
Hold this key down to feed paper from the printer.
- ② **Ten key pad** 0, 1, ~ 9, 00, .
Use these keys to input numbers.
- ③ **Clear key** C
Use this key to clear an entry that has not yet been registered.
- ④ **Cash amount tendered key** CA/AMT/TEND
Use this key to register a cash sale.
- ⑤ **Check key** CHK
Use this key to register a check tender.
- ⑥ **Subtotal key** SUB TOTAL
Use this key to display and print the current subtotal (includes add-on tax) amount.
- ⑦ **Help key** HELP
Use this key to look up the procedures to set date/time, tax table etc.
- ⑧ **Tax program key** TAX PGM
Use this key to set the tax status and tax table.
- ⑨ **Clerk number key** CLK#
Use this key to sign clerk on and off the register.
- ⑩ **Sign off key** SIGN OFF
Use this key to sign clerk off the register.
- ⑪ **Received on account key** RC
Use this key following a numeric entry to register money received for non-sale transactions.
- ⑫ **Paid out key** PD
Use this key following a numeric entry to register money paid out from the drawer.
Use this key to convert the main currency to the sub currency (the euro/the local money), when registering a subtotal amount. This key is also used for specifying sub currency while entering an amount of payment or declaration in drawers.
- ⑬ **Reduction (minus) key** -
Use this key to input values for reduction.
- ⑭ **Discount key** %-
Use this key to register discounts.
- ⑮ **Receipt on/off key** RECEIPT ON/OFF
Use this key twice to change the status “receipt issue” or “no receipt.”
- ⑯ **Price key** PRICE
Use this key to register unit prices for subdepartment.
- ⑰ **PLU key** PLU
Use this key to input PLU (subdepartment) numbers.
- ⑱ **Refund key** RF
Use this key to input refund amounts and void certain entries.
- ⑲ **Multiplication/Date/Time key** x/DATE TIME
Use this key to input a quantity for a multiplication.
Between transactions, this key displays the current time and date.

- ⑳ **Error correct / Cancel key** 

Use this key to correct registration errors and to cancel registration of entire transactions.
- ㉑ **Post receipt key** 

Use this key to produce a post-finalization receipt.
- ㉒ **Department keys** , , ~

Use these keys to register items to departments.
- ㉓ **Charge key** 







Use this key to register a charge sale.
- ㉔ **Currency exchange key** , 

Use this key for calculating subtotal amounts or paying amount due in foreign currency.
- ㉕ **Premium key** 

Use this key to register premiums.
- ㉖ **Open key** 

Use this key to temporarily release a limitation on the number of digits that can be input for a unit price.
- ㉗ **Department no. / Department shift key** 

Department no.: Use this key to input department numbers.
 Department shift: Use this key to shift the department key number from 1 through 25 to 26 through 50.

 ⇨ Dept 01	  ⇨ Dept 26
 ⇨ Dept 02	  ⇨ Dept 27
:	:

- ㉘ **Coupon key** 

Use this key to register coupons.
- ㉙ **Non-add key** 

Use this key to print reference number (to identify a personal check, credit card, etc.) during a transaction, use this key after some numerical entries.
- ㉚ **No sale key** 

Use this key to open the drawer without registering anything.
- ㉛ **VAT key** 

Use this key to print a VAT breakdown.

How to read the printouts

- The journal / receipts are records of all transactions and operations.
- The contents printed on receipts and journal are almost identical.
- You can choose the journal skip function.

If the journal skip function is selected, the cash register will print the total amount of each transaction, and the details of premium, discount and reduction operations only, without printing department and PLU item registrations on the journal.

- The following items can be skipped on receipts and journal.
 - Taxable status
 - Taxable amount
 - Item counter

Receipt Sample

<pre>***** * THANK YOU * ** CALL AGAIN ** ***** * COMMERCIAL MESSAGE * * COMMERCIAL MESSAGE * * COMMERCIAL MESSAGE * * COMMERCIAL MESSAGE * New Year Sale 1st Anniversary 10% OFF  HAPPY NEW YEAR REG 03-06-2008 11:58 C01 0001 000123 1 DEPT001 T1 -1.00 1 DEPT002 T1 -2.00 5 DEPT003 -5.00 7 No TA1 -3.00 TX1 -0.15 TL -8.15 CASH -10.00 CG -1.85 *** BOTTOM MESSAGE *** *** BOTTOM MESSAGE *** *** BOTTOM MESSAGE *** *** BOTTOM MESSAGE ***</pre>	<p>Logo message</p> <p>Commercial message</p> <p>Preset message *1</p> <p>Preset graphic *1</p> <p>Mode/Date/Time Clerk/Machine No. Consecutive No.</p> <p>Q'ty/Item</p> <p>Item counter</p> <p>Bottom message</p>
---	--

Journal Sample (Item lines Included)

```
REG 03-06-2008 11:58
C01 0001 000123
1 DEPT001 T1 -1.00
1 DEPT002 T1 -2.00
5 DEPT003 -5.00

          7 No
          TA1 -3.00
          TX1 -0.15
          TL -8.15
          CASH -10.00
          CG -1.85

REG 03-06-2008 11:59
C01 0001 000124
1 DEPT001 T1 -1.00
1 DEPT012 T1 -1.00
5 DEPT003 -6.00

          7 No
          TA1 -2.00
          TX1 -0.10
          TL -8.10
          CASH -10.00
          CG -1.90

REG 03-06-2008 11:59
C01 0001 000124
```

Journal Sample (by half height character)

```
REG 03-06-2008 11:58
C01 0001 000123
1 DEPT001 T1 -1.00
1 DEPT002 T1 -2.00
5 DEPT003 -5.00

          7 No
          TA1 -3.00
          TX1 -0.15
          TL -8.15
          CASH -10.00
          CG -1.85

REG 03-06-2008 11:59
C01 0001 000124
1 DEPT001 T1 -1.00
1 DEPT012 T1 -1.00
5 DEPT003 -6.00

          7 No
          TA1 -2.00
          TX1 -0.10
          TL -8.10
          CASH -10.00
          CG -1.90

REG 03-06-2008 11:59
C01 0001 000125
```

*1 You can choose to print preset message and graphic at the top of the receipt or at the bottom of the receipt.

In the operation examples contained in this manual, the print samples are what would be produced if the roll paper is being used for receipts. They are not actual size. Actual receipts are 58 mm wide. Also, all sample receipts and journals are printout images.

How to use your cash register

The following describes the general procedure you should use in order to get the most out of your cash register.

BEFORE business hours...

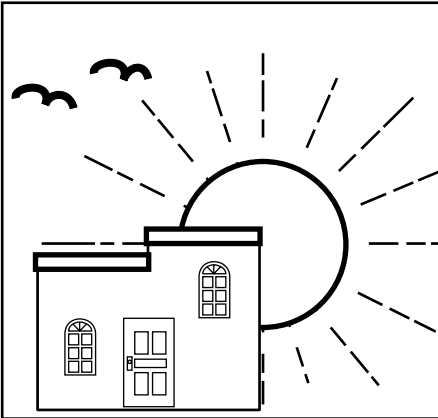

- Check to make sure that the cash register is plugged in securely. Page 13
- Check to make sure there is enough paper left on the roll. Pages 11, 12
- Read the flash report to confirm that totals are all zero. Page 77
- Check the date and time. Page 28

DURING business hours...

- Register transactions. Page 29 -
- Periodically read totals. Page 76

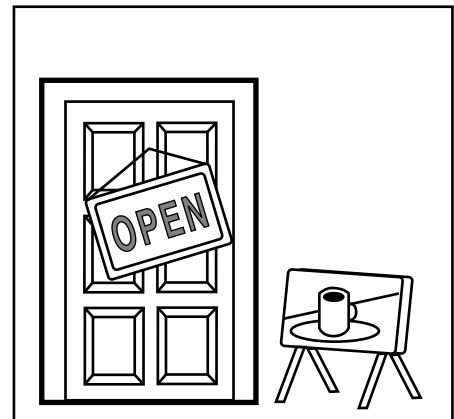

AFTER business hours...

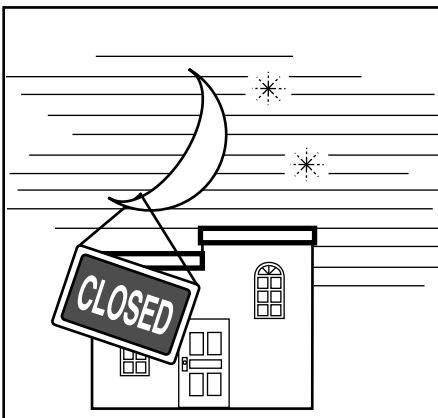

- Issue electronic journal report (if necessary). Page 77
- Reset the daily totals. Page 45, 78
- Remove the journal. Page 92
- Empty the cash drawer and leave it open. Page 21
- Take the cash and journal to the office.

Before business hours

Checking the time and date

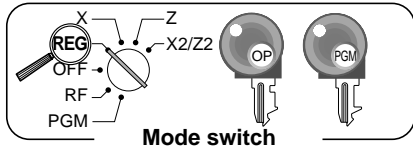

You can show the time or date on the display of the cash register whenever there is no registration being made.

To display and clear the date/time

OPERATION

DISPLAY

 Date/time appears on the display.

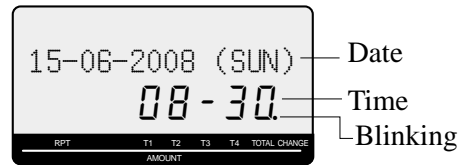

 Clears the date/time display.



Preparing coins for change

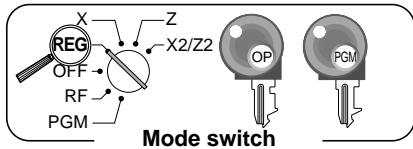

You can use the following procedure to open the drawer without registering an item. This operation must be performed out of a sale. (You can use the  key instead of this key. See page 41.)

Opening the drawer without a sale

OPERATION

RECEIPT





Preparing and using department keys

Registering department keys

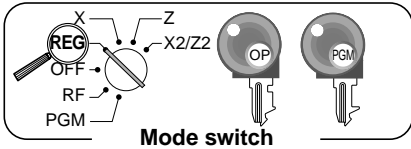

The following examples show how you can use the department keys in various types of registrations.

Single item sale

Example 1

OPERATION

RECEIPT

Item	Unit price	\$1.00
	Quantity	1
	Dept.	1
Payment	Cash	\$1.00

1 00
Unit price

1 DEPT001	.1.00	Department No./ unit price
TL	- 1.00	Total amount
CASH	.1.00	

1

Department

CA/AMT
/TEND

Example 2 (Subtotal registration and change computation)

OPERATION

RECEIPT

Item	Unit price	\$12.34
	Quantity	1
	Dept.	1
Payment	Cash	\$20.00

1 2 3 4
Unit price

1 DEPT001	.12.34	Total amount
TL	- 12.34	Amount tendered
CASH	.20.00	Change
CG	.7.66	

1

Department

SUB
TOTAL

2 0 00 CA/AMT
/TEND

Amount tendered

Repeat

OPERATION

RECEIPT

Item	Unit price	\$1.50
	Quantity	3
	Dept.	1
Payment	Cash	\$10.00

1 5 0 **1**

1 DEPT001	.1.50	Repeat
1 DEPT001	.1.50	Repeat
1 DEPT001	.1.50	
TL	- 4.50	
CASH	.10.00	
CG	.5.50	

1

1

SUB
TOTAL

1 0 00 CA/AMT
/TEND

Basic Operations and Setups

Multiplication

OPERATION

RECEIPT

Item	Unit price	\$1.00
	Quantity	12
	Dept.	1
Payment	Cash	\$20.00

Quantity
 (4-digit integer/3-digit decimal)

12 DEPT001		·12.00	Quantity/result
TL	-	12.00	
CASH		·20.00	
CG		·8.00	

Department shift

OPERATION

RECEIPT

Item	Unit price	\$1.00
	Quantity	1
	Dept.	26
Payment	Cash	\$1.00

Designating upper department
 press first.
 (- 2 - shows).

1 DEPT026		·1.00
TL	-	1.00
CASH		·1.00

Department number

OPERATION

RECEIPT

Item	Unit price	\$13.00
	Quantity	1
	Dept.	31
Payment	Cash	\$13.00

Department No.

Unit price

1 DEPT031		·13.00
TL	-	13.00
CASH		·13.00

Programming department keys

To program a unit price for each department

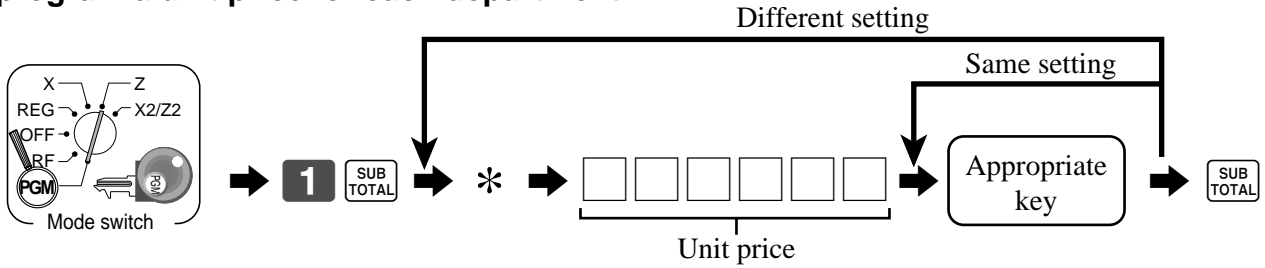

* In case of shifting upper department, press key here.

To program the tax calculation status for each department

Tax calculation status

This specification defines which tax table should be used for automatic tax calculation.

Programming procedure

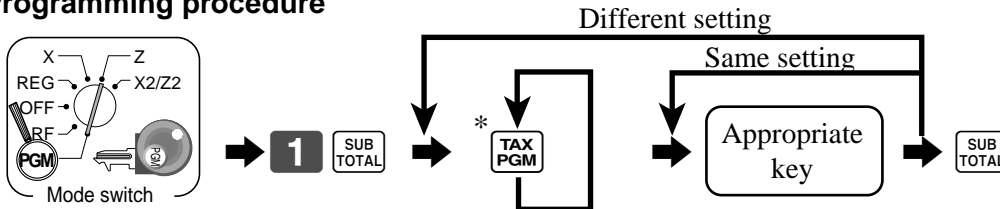

* Press key repeatedly until the status you want to program is appeared on the display.



Appropriate key: In case of shifting department, press key first.

To program high amount limit for each department

Programming procedure

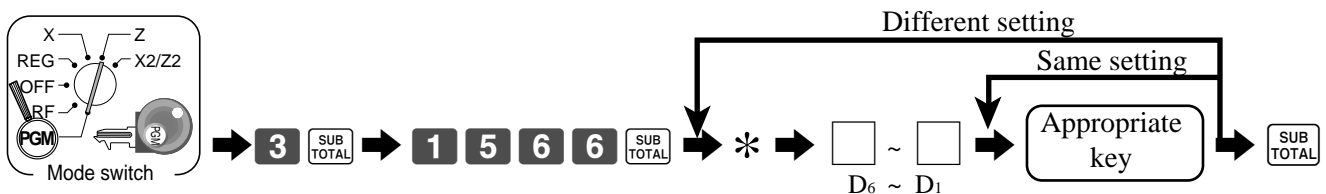

* In case of shifting upper department, press key here.

Description	Choice	Program code
High amount limit for entering unit price manually.	Significant numbers	<input type="text"/> ~ <input type="text"/> D ₆ ~ D ₁

Basic Operations and Setups

Registering department keys by programming data

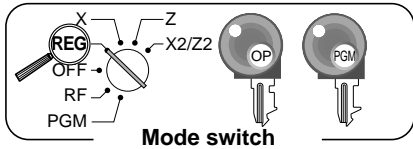

Preset price

Item	Unit price	(\$1.00) _{preset}
	Quantity	1
	Dept.	2
Payment	Cash	\$1.00

OPERATION

2
CA/AMT
TEND

RECEIPT

1 DEPT002		·1.00
TL	-	1.00
CASH		·1.00

Department No./
unit price

Preset tax status

Item 1	Unit price	(\$2.00) _{preset}
	Quantity	5
	Dept.	3
	Taxable	(1) _{preset}
Item 2	Unit price	(\$2.00) _{preset}
	Quantity	1
	Dept.	4
	Taxable	(2) _{preset}
Payment	Cash	\$20.00

OPERATION

5 DATE
TIME
3
4
SUB
TOTAL
2 0 0 0 CA/AMT
TEND

RECEIPT

5 DEPT003	T1	·10.00
1 DEPT004	T2	·2.00
TA1		·10.00
TX1		·0.40
TA2		·2.00
TX2		·0.20
TL	-	12.60
CASH		·20.00
CG		·7.40

Tax status

Taxable Amount 1
Tax 1
Taxable Amount 2
Tax 2

Locking out high amount limitation

Item	Unit price	\$1.05
	Quantity	1
	Dept.	3
	Max.amount	(\$10.00) _{preset}
Payment	Cash	\$2.00

OPERATION

1 0 5 0 3
ERROR ALARM
(Exceeding high amount)
C
1 0 5 3
SUB
TOTAL
2 0 0 CA/AMT
TEND

RECEIPT

1 DEPT003		·1.05
TL	-	1.05
CASH		·2.00
CG		·0.95

Preparing and using PLUs

This section describes how to prepare and use PLUs.

CAUTION:

Before you use PLUs, you must first program the unit price and tax status.

Programming PLUs

To program a unit price for each PLU

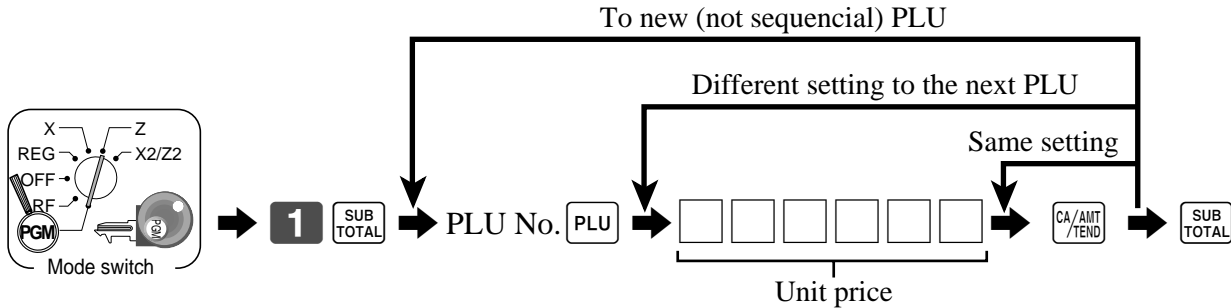

To program tax calculation status for each PLU

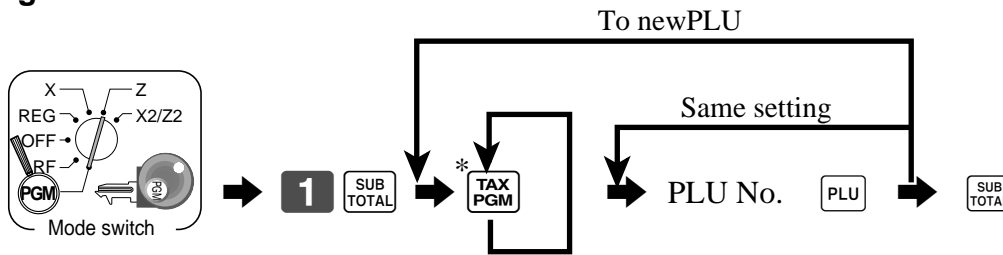

* Press **TAX PGM** key repeatedly until the status you want to program is appeared on the display.



Basic Operations and Setups

Registering PLUs

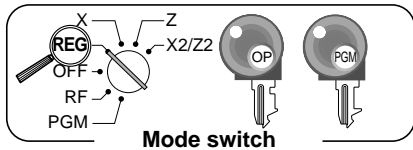

The following examples show how you can use PLUs in various types of registrations.

PLU single item sale

Item	Unit price	(\$2.50) _{preset}
	Quantity	1
	PLU	14
Payment	Cash	\$3.00

OPERATION

1 4
 PLU code
PLU
SUB TOTAL
3 00 CA/AMT TEND

RECEIPT

1 PLU0014	-2.50	← PLU No./unit price
TL	- 2.50	
CASH	-3.00	
CG	-0.50	

PLU repeat

Item	Unit price	(\$2.50) _{preset}
	Quantity	3
	PLU	14
Payment	Cash	\$10.00

OPERATION

1 4 PLU
PLU
PLU
SUB TOTAL
1 0 00 CA/AMT TEND

RECEIPT

1 PLU0014	-2.50
1 PLU0014	-2.50
1 PLU0014	-2.50
TL	- 7.50
CASH	-10.00
CG	-2.50

PLU multiplication

Item	Unit price	(\$2.00) _{preset}
	Quantity	10
	PLU	7
Payment	Cash	\$20.00

OPERATION

1 0 X/DATE TIME
 Quantity
 (4-digit integer/3-digit decimal)
7 PLU
SUB TOTAL
2 0 00 CA/AMT TEND

RECEIPT

10 PLU0007	-20.00	← Quantity/result
TL	- 20.00	
CASH	-20.00	
CG	-0.00	

Open PLU

OPERATION			RECEIPT														
Item 1	Unit price	\$32.80	3 0	PLU	<table style="width: 100%; border-collapse: collapse;"> <tr><td style="width: 50%;">1 PLU0030</td><td style="text-align: right;">-32.80</td></tr> <tr><td>1 PLU0031</td><td style="text-align: right;">-13.00</td></tr> <tr><td>1 PLU0031</td><td style="text-align: right;">-13.00</td></tr> <tr><td>TL</td><td style="text-align: right;">-58.80</td></tr> <tr><td>CASH</td><td style="text-align: right;">-60.00</td></tr> <tr><td>CG</td><td style="text-align: right;">-1.20</td></tr> </table>	1 PLU0030	-32.80	1 PLU0031	-13.00	1 PLU0031	-13.00	TL	-58.80	CASH	-60.00	CG	-1.20
	1 PLU0030	-32.80															
	1 PLU0031	-13.00															
1 PLU0031	-13.00																
TL	-58.80																
CASH	-60.00																
CG	-1.20																
Quantity	1	3 2 8 0	PRICE														
PLU	30	Unit price															
Item 2	Unit price	\$13.00	3 1	PLU													
	Quantity	2	1 3 00	PRICE													
	PLU	31	Repeat														
Payment	Cash	\$60.00	SUB TOTAL														
			6 0 00	CA/AMT /TEND													

- Before registering an open PLU, it is necessary to preset it as an open PLU.

Preparing and using discounts

This section describes how to prepare and register discounts.

Programming discounts

To program a rate to the $\%-\$ key

The diagram shows a mode switch with positions X, Z, REG, OFF, RF, and PGM. An arrow points from the PGM position to a sequence of keypad actions: pressing the '1' key, the 'SUB TOTAL' key, a four-digit display box labeled 'Preset rate', the $\%-\$ key, and finally the 'SUB TOTAL' key.

Example: 10.0% \Rightarrow **1 0** 5.5% \Rightarrow **5 . 5**
 12.34% \Rightarrow **1 2 . 3 4**

To program the tax calculation status to the $\%-\$ key

Refer to page 31.

Registering discounts

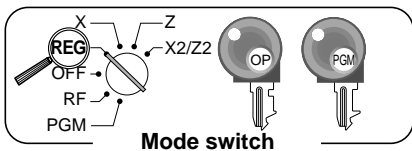

The following example shows how you can use the $\%-\$ key in various types of registration.

Discount for items and subtotals

OPERATION			RECEIPT
Item 1	Dept. 1	\$5.00	<pre> 1 DEPT001 T1 -5.00 1 PLU0016 T2 -10.00 5% %- T2 -0.50 ST -14.50 3.5% %- -0.51 TA1 -5.00 TX1 -0.20 TA2 -9.50 TX2 -0.48 TL -14.67 CASH -15.00 CG -0.33 </pre>
	Quantity	1	
	Taxable	(1) _{preset}	
Item 2	PLU 16	(\$10.00) _{preset}	
	Quantity	1	
	Taxable	(2) _{preset}	
Discount	Rate	(5%) _{preset}	
Subtotal discount	Rate	3.5%	
	Taxable	Nontaxable	
Payment	Cash	\$15.00	

- You can manually input rates up to 4 digits long (0.01% to 99.99%).

Taxable status of the $\%-\$ key

- Whenever you perform a discount operation on the last item registered, the tax calculation for discount amount is performed in accordance with the tax status programmed for that item.
- Whenever you perform a discount operation on a subtotal amount, the tax calculation for the subtotal amount is performed in accordance with the tax status programmed for the $\%-\$ key.

Preparing and using reductions

This section describes how to prepare and register reductions.

Programming for reductions

You can use the **[-]** key to reduce single item or subtotal amounts.

To program preset reduction amount

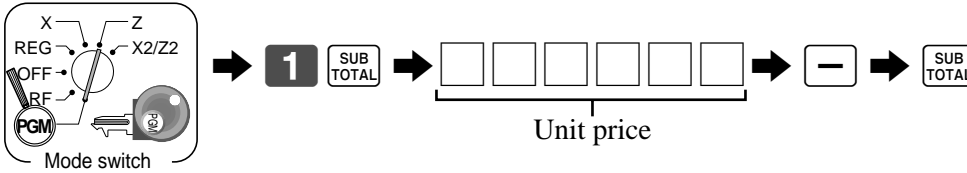

To program the tax calculation status to the **[-]** key

Refer to page 31.

Registering reductions

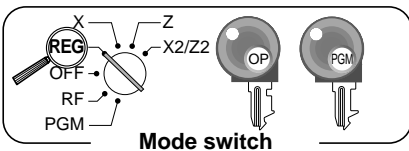

The following examples show how you can use the **[-]** key in various types of registration.

Reduction for items and subtotal

	OPERATION	RECEIPT
Item 1	Dept. 1 \$5.00	
	Quantity 1	
	Taxable (1) _{preset}	
Reduction	Amount \$0.25	
Item 2	PLU 45 (\$6.00) _{preset}	
	Quantity 1	
	Taxable (1) _{preset}	
Reduction	Amount (\$0.50) _{preset}	
Subtotal	Amount \$0.75	
Reduction	Taxable (No) _{preset}	
Payment	Cash \$10.00	

5 00	1	
2 5	[-]	
Reduces the last amount registered by the value input.		
4 5	PLU	
	[-]	
	SUB TOTAL	
7 5	[-]	
1 0 00	CA/AMT TEND	

1 DEPT001	T1	-5.00
-	T1	-0.25
1 PLU0045	T1	-6.00
-	T1	-0.50
-		-0.75
TA1		·10.25
TX1		·0.41
TL		- 9.91
CASH		·10.00
CG		·0.09

- You can manually input reduction values up to 7 digits long.
- If you want to subtract the reduction amount from the department or PLU totalizer, program “Net totaling.”

Basic Operations and Setups

Registering credit and check payments

The following examples show how to register credits and payments by check.

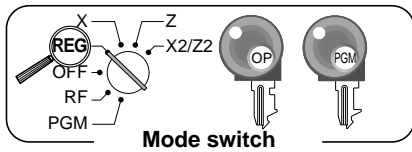

Check

OPERATION			RECEIPT														
Item	Dept. 1	\$11.00	1	1	<table border="1" style="width: 100%; border-collapse: collapse;"> <tr> <td style="width: 15%;">1 DEPT001</td> <td style="width: 15%;">· 11.00</td> <td rowspan="4" style="width: 10%; vertical-align: middle;">Reference No.</td> </tr> <tr> <td>#</td> <td>1234</td> </tr> <tr> <td>TL</td> <td>- 11.00</td> </tr> <tr> <td>CHECK</td> <td>· 20.00</td> </tr> <tr> <td>CG</td> <td>· 9.00</td> <td></td> </tr> </table>	1 DEPT001	· 11.00	Reference No.	#	1234	TL	- 11.00	CHECK	· 20.00	CG	· 9.00	
1 DEPT001	· 11.00	Reference No.															
#	1234																
TL	- 11.00																
CHECK	· 20.00																
CG	· 9.00																
	Quantity	1															
Reference	Number	1234	1 2 3 4	#													
Payment	Check	\$20.00	2 0 00	CHK													

Charge

OPERATION			RECEIPT								
Item	Dept. 4	\$15.00	1	5	<table border="1" style="width: 100%; border-collapse: collapse;"> <tr> <td style="width: 15%;">1 DEPT004</td> <td style="width: 15%;">· 15.00</td> </tr> <tr> <td>TL</td> <td>- 15.00</td> </tr> <tr> <td>CHARGE</td> <td>· 15.00</td> </tr> </table>	1 DEPT004	· 15.00	TL	- 15.00	CHARGE	· 15.00
1 DEPT004	· 15.00										
TL	- 15.00										
CHARGE	· 15.00										
	Quantity	1									
Payment	Charge	\$15.00	4	SUB TOTAL							
				CH							

Credit

OPERATION			RECEIPT								
Item	Dept. 3	\$10.00	1	0	<table border="1" style="width: 100%; border-collapse: collapse;"> <tr> <td style="width: 15%;">1 DEPT003</td> <td style="width: 15%;">· 10.00</td> </tr> <tr> <td>TL</td> <td>- 10.00</td> </tr> <tr> <td>CREDIT</td> <td>· 10.00</td> </tr> </table>	1 DEPT003	· 10.00	TL	- 10.00	CREDIT	· 10.00
1 DEPT003	· 10.00										
TL	- 10.00										
CREDIT	· 10.00										
	Quantity	1									
Payment	Credit	\$10.00	00	3							
				SUB TOTAL							
				CR							

Mixed tender (cash and check)

OPERATION			RECEIPT													
Item	Dept. 4	\$55.00	5	5	<table border="1" style="width: 100%; border-collapse: collapse;"> <tr> <td style="width: 15%;">1 DEPT004</td> <td style="width: 15%;">· 55.00</td> </tr> <tr> <td>TL</td> <td>- 55.00</td> </tr> <tr> <td>CHECK</td> <td>· 30.00</td> </tr> <tr> <td>CASH</td> <td>· 25.00</td> </tr> <tr> <td>CG</td> <td>· 0.00</td> <td></td> </tr> </table>	1 DEPT004	· 55.00	TL	- 55.00	CHECK	· 30.00	CASH	· 25.00	CG	· 0.00	
1 DEPT004	· 55.00															
TL	- 55.00															
CHECK	· 30.00															
CASH	· 25.00															
CG	· 0.00															
	Quantity	1														
Payment	Check	\$30.00	3	0												
	Cash	\$25.00	2	5												
			00	CHK												
			00	CA/AMT TEND												

Registering both the Euro and local currency

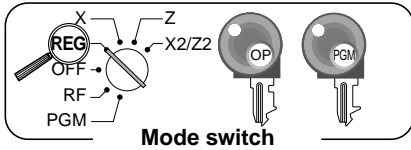

The following example shows the basic operation using the currency exchange function between the Euro and the local currency.

Case A: Main currency = Local, Payment = Euro, Change = Local

OPERATION

DISPLAY

6 0 0 **1**

PD

← Press the **PD** key, which converts the subtotal amount into the sub currency by applying the preset exchange rate.

SUB TOTAL

After you press the **SUB TOTAL** key, the result is shown on the display.



PD

← Press the **PD** key if you enter the payment in the sub currency.

1 5 00

CA/AMT/TEND

← Press the **CA/AMT/TEND** key to finalize the transaction.

The change amount is shown in the programmed currency.



Case B: Main currency = Euro, Payment = Local, Change = Euro

1 2 00 **1**

PD

← Press the **PD** key, which converts the subtotal amount into the sub currency by applying the preset exchange rate.

SUB TOTAL

After you press the **SUB TOTAL** key, the result is shown on the display.



PD

← Press the **PD** key if you enter the payment in the sub currency.

6 00

CA/AMT/TEND

← Press the **CA/AMT/TEND** key to finalize the transaction.

The change amount is shown in the programmed currency.

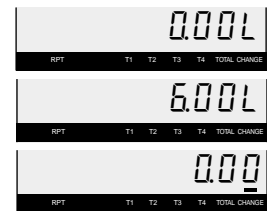

RECEIPT (Case A)

1 DEPT001	·6.00
TL	- 6.00
	(€12.00)
EURO money	
CASH	€15.00
CASH	(·7.50)
CG	·1.50
	(€3.00)

Receipt (Case B)

1 DEPT001	€12.00
TL	€12.00
	(·6.00)
LOCAL money	
CASH	·6.00
CASH	(€12.00)
CG	€0.00
	(·0.00)

Registering returned goods in the REG mode

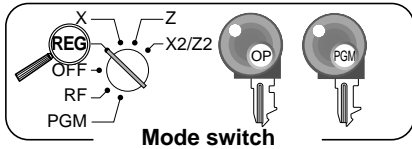

The following example shows how to use the **RF** key in the REG mode to register goods returned by customers.

OPERATION

RECEIPT

Item 1	Dept. 1	\$2.35
	Quantity	1
Item 2	Dept. 2	\$2.00
	Quantity	1
Item 3	PLU 1 (\$1.20) _{preset}	
	Quantity	1
Returned Item 1	Dept. 1	\$2.35
	Quantity	1
Returned Item 3	PLU 1 (\$1.20) _{preset}	
	Quantity	1
Payment	Cash	\$2.00

2 3 5 1

2 00 2

1 **PLU**

RF

2 3 5 1

Press **RF** before the item you want to return.

RF

1 **PLU**

SUB TOTAL

CA/AMT TEND

1	DEPT001	·2.35
1	DEPT002	·2.00
1	PLU0001	·1.20
	RF
1	DEPT001	-2.35
	RF
1	PLU0001	-1.20
	TL	- 2.00
	CASH	·2.00

Registering returned goods in the RF mode

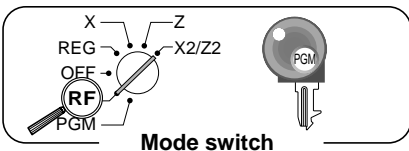

The following examples show how to use the RF mode to register goods returned by customers.

OPERATION

RECEIPT

Returned Item 1	Dept. 3	\$4.00
	Quantity	1
Reduction	Amount	\$0.15
Returned Item 2	PLU 2 (\$1.20) _{preset}	
	Quantity	1
Discount	Rate	(5%) _{preset}
Payment	Cash	\$4.99

4 00 3

1 5 -

2 **PLU**

%-

SUB TOTAL

CA/AMT TEND

1	DEPT003	·4.00
	-	-0.15
1	PLU0002	·1.20
	5%	
	%-	-0.06
	TL	- 4.99
	CASH	·4.99

Important

- To avoid miss registrations in the RF mode, return the mode switch to the former position immediately.

Registering money received on account

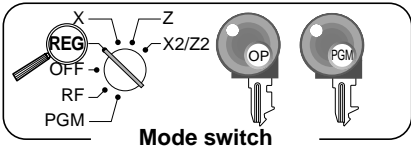

The following example shows how to register money received on account. This registration must be performed out of a sale.

	OPERATION	RECEIPT	
--	-----------	---------	--

Received amount	\$700.00
-----------------	----------

7 00 00 RC

RC	.700.00
----	---------

Amount can be up to 8 digits.

Registering money paid out

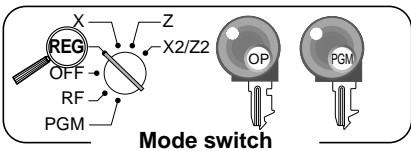

The following example shows how to register money paid out from the register. This registration must be performed out of a sale.

	OPERATION	RECEIPT	
--	-----------	---------	--

Paid out amount	\$1.50
-----------------	--------

1 5 0 PD

PD	.1.50
----	-------

Amount can be up to 8 digits.

No sale registration

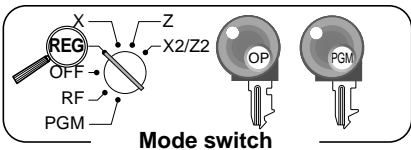

You can use the following procedure to open the drawer without registering a sale. This operation must be performed out of a sale.

	OPERATION	RECEIPT	
--	-----------	---------	--

NS

NS
----	-------

Making corrections in a registration

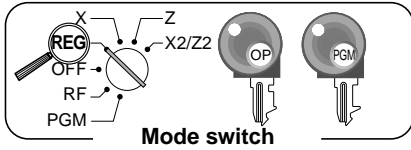

There are three techniques you can use to make corrections in a registration.

- To correct an item that you input but not yet registered.
- To correct the last item you input and registered.
- To cancel all items in a transaction.

To correct an item you input but not yet registered

OPERATION

RECEIPT

<p>2 00</p> <p>1 00 C</p> <p>1 2 X/DATE TIME</p> <p>1 1 X/DATE TIME</p> <p>2 00 2</p> <p>2</p> <p>3 PLU</p> <p>1 5 PLU</p> <p>6 00</p> <p>1 5 PLU</p> <p>Enter PLU No. again.</p> <p>1 0 00 PRICE</p> <p>SUB TOTAL</p> <p>1 0 00</p> <p>1 5 00 CA/AMT TEND</p> <p>CH</p>	<p>Correction of unit price</p> <p>Correction of quantity</p> <p>Correction of PLU No.</p> <p>Correction of open PLU unit price</p> <p>Correction of partial tender amount</p>	<table border="0"> <tr><td>1 DEPT001</td><td style="text-align: right;">·1.00</td></tr> <tr><td>11 DEPT002</td><td style="text-align: right;">·22.00</td></tr> <tr><td>1 PLU0003</td><td style="text-align: right;">·1.30</td></tr> <tr><td>1 PLU0015</td><td style="text-align: right;">·10.00</td></tr> <tr><td>TL</td><td style="text-align: right;">- 34.30</td></tr> <tr><td>CASH</td><td style="text-align: right;">·15.00</td></tr> <tr><td>CHARGE</td><td style="text-align: right;">·19.30</td></tr> </table>	1 DEPT001	·1.00	11 DEPT002	·22.00	1 PLU0003	·1.30	1 PLU0015	·10.00	TL	- 34.30	CASH	·15.00	CHARGE	·19.30
1 DEPT001	·1.00															
11 DEPT002	·22.00															
1 PLU0003	·1.30															
1 PLU0015	·10.00															
TL	- 34.30															
CASH	·15.00															
CHARGE	·19.30															

To correct an item you input and registered

OPERATION

RECEIPT

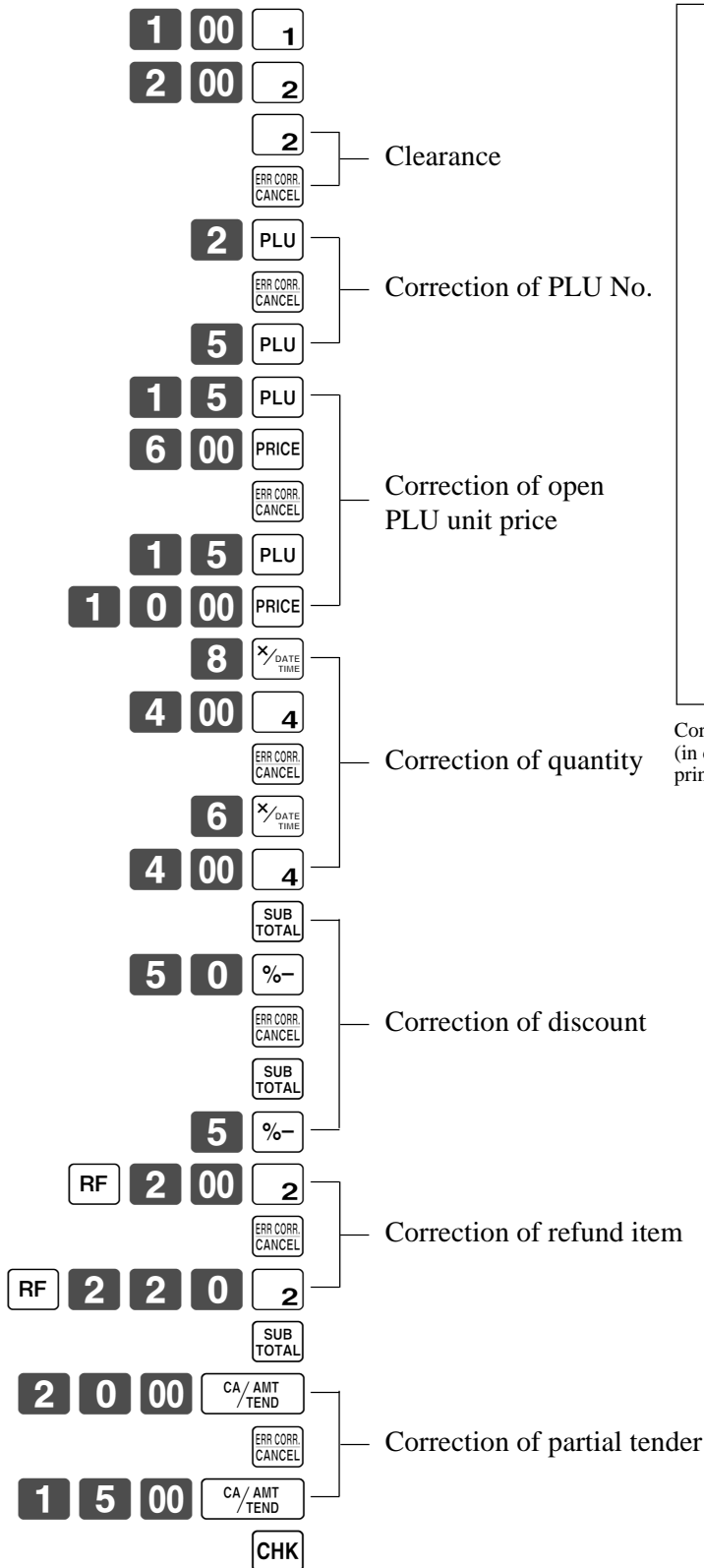

1	DEPT001	-1.00
1	DEPT002	-2.00
1	DEPT002	-2.00
	CORR	-2.00
1	PLU0002	-2.00
	CORR	-2.00
1	PLU0005	-1.50
1	PLU0015	-6.00
	CORR	-6.00
1	PLU0015	-10.00
8	DEPT004	-32.00
	CORR	-32.00
6	DEPT004	-24.00
	ST	-38.50
	50%	
	%-	-19.25
	CORR	-19.25
	ST	-38.50
	5%	
	%-	-1.93
	RF
1	DEPT	-2.00
	CORR	-2.00
	RF
1	DEPT002	-2.20
	TL	-34.37
	CASH	-20.00
	CORR	-20.00
	CASH	-15.00
	CHECK	-19.37

Corrected items are not printed on receipt (in case of programming "Buffered receipt printing").

Basic Operations and Setups

To cancel all items in a transaction

OPERATION	RECEIPT																						
<table border="1"><tr><td>1</td><td>00</td><td>1</td></tr><tr><td>2</td><td>00</td><td>2</td></tr><tr><td>3</td><td>00</td><td>3</td></tr><tr><td>4</td><td>00</td><td>4</td></tr></table>	1	00	1	2	00	2	3	00	3	4	00	4	<table border="1"><tr><td>1 DEPT001</td><td>-1.00</td></tr><tr><td>1 DEPT002</td><td>-2.00</td></tr><tr><td>1 DEPT003</td><td>-3.00</td></tr><tr><td>1 DEPT004</td><td>-4.00</td></tr><tr><td>CANCEL</td><td>.....</td></tr></table>	1 DEPT001	-1.00	1 DEPT002	-2.00	1 DEPT003	-3.00	1 DEPT004	-4.00	CANCEL
1	00	1																					
2	00	2																					
3	00	3																					
4	00	4																					
1 DEPT001	-1.00																						
1 DEPT002	-2.00																						
1 DEPT003	-3.00																						
1 DEPT004	-4.00																						
CANCEL																						
<table border="1"><tr><td>SUB TOTAL</td></tr></table>	SUB TOTAL																						
SUB TOTAL																							
Pressing <table border="1"><tr><td>SUB TOTAL</td></tr></table> key is necessary to cancel the transaction.	SUB TOTAL																						
SUB TOTAL																							
<table border="1"><tr><td>ERR CORR. CANCEL</td></tr></table>	ERR CORR. CANCEL																						
ERR CORR. CANCEL																							

Printing the daily sales reset report

This report shows daily sales totals.

OPERATION

REPORT

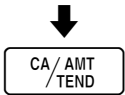
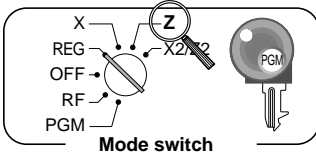

Z	03-06-2008 17:00	Date/time
	0001 000231	Machine No./consecutive No.
Z	DAILY Z	Report title
Z	DEPT 0001	Department report title/reset counter
	0001015	Report code
DEPT001	203.25	Department count/amount *1
	·1,108.54	
DEPT002	183	
	·1,362.26	
	5	
TL	421.25	Department total count/total amount
	·2,872.28	
Z	FIX 0001	Fixed total report title/reset counter
	0001011	Report code
GROSS	981.25	Gross total *2
	·6,574.40	
NET	No 111	Net total *2
	·7,057.14	
CAID	·1,919.04	Cash in drawer *2
CHID	·139.04	Charge in drawer *2
CKID	·859.85	Check in drawer *2
CRID(1)	·709.85	Credit in drawer 1 *2
CRID(2)	·0.00	Credit in drawer 2 *2
CRID(3)	·0.00	Credit in drawer 3 *2
CRID(4)	·0.00	Credit in drawer 4 *2
RF	No 3	Refund mode *2
	·10.22	
CUST	CT 111	Number of customer *2
AVRG	·63.57	Average sales per customer *2
DC	·1.22	Discount total *2
REF	·2.42	Refund key *2
ROUND	·0.00	Rounding total *2
CANCEL	No 2	Cancellation *2
	·12.97	

TA1	·2,369.69	Taxable 1 amount *2
TX1	·128.86	Tax 1 amount *2
TA2	·2,172.96	Taxable 2 amount *2
TX2	·217.33	Tax 2 amount *2
GT	·00000000125478.96	Grand total *2
Z	TRANS 0001	Function key report title/reset counter
	0001012	Report code
CASH	No 362	Function key count/amount *1
	·1,638.04	
CHARGE	No 56	
	·1,174.85	
RC	No 4	
	·810.00	
PD	No 5	
	·520.00	
	·5.00	
CORR	No 14	
	·39.55	
RCT	No 3	
	·5	

*1 Zero totalled departments/functions (the amount and item numbers are both zero) are not printed.

*2 These items can be skipped by programming.

Using clerk functions

Enable clerk feature

Please follow the below procedure to enable clerk feature.

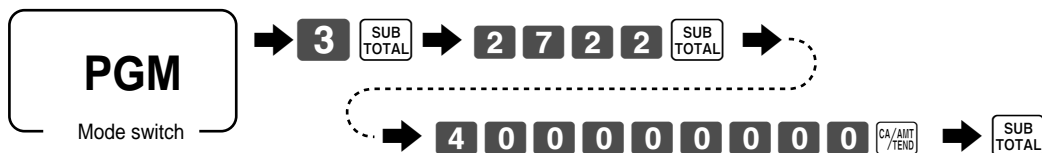

Assigning a clerk

You can assign clerks by using clerk number.

Clerk number key

Clerk sign on

Signing clerk 1 on:

1 →

Signing clerk 2 on:

2 →

Clerk number :
:

OPERATION

RECEIPT

```
* COMMERCIAL MESSAGE *
REG 03-06-2008 11:58
C01 0001 000123
1 DEPT01
```

Clerk name/machine No./consecutive No.

- If you do not want the clerk number to be shown on the display, press before entering the number.

Clerk sign off

Signing clerk off:
(except PGM mode)

OPERATION

- The current clerk is also signed off whenever you set the mode switch to OFF position.

Important!

- The error code "E008" appears on the display whenever you try to perform a registration, a read/reset operation without signing on.
- The signed on clerk is also identified on the receipt/journal.

Single item cash sales

A department key or PLU programmed with single item sale status finalizes the transaction as soon as it is registered.

The single item sales function can only be used for cash sales.

Example 1

OPERATION			RECEIPT																				
	Dept. 1	\$1.00	1	00	1																		
Item	Quantity	1	The transaction is immediately finalized.																				
	Status	S.I.S																					
Payment	Cash	\$1.00	<table style="width: 100%; border-collapse: collapse;"> <tr> <td style="width: 10%;">1 DEPT001</td> <td style="width: 10%;"></td> <td style="width: 10%; text-align: right;">.1.00</td> <td style="width: 10%;"></td> <td style="width: 10%;"></td> <td style="width: 10%; font-size: small;">Department No./ unit price</td> </tr> <tr> <td>TL</td> <td style="text-align: right;">- 1.00</td> <td></td> <td></td> <td></td> <td></td> </tr> <tr> <td>CASH</td> <td></td> <td style="text-align: right;">.1.00</td> <td></td> <td></td> <td style="font-size: small;">Cash total amount</td> </tr> </table>			1 DEPT001		.1.00			Department No./ unit price	TL	- 1.00					CASH		.1.00			Cash total amount
1 DEPT001		.1.00			Department No./ unit price																		
TL	- 1.00																						
CASH		.1.00			Cash total amount																		

Example 2

OPERATION			RECEIPT																					
	Dept. 1	(\$1.00)	3	<input checked="" type="checkbox"/> DATE TIME																				
Item	Quantity	3	The transaction is immediately finalized.																					
	Status	S.I.S																						
Payment	Cash	\$3.00	1	<table style="width: 100%; border-collapse: collapse;"> <tr> <td style="width: 10%;">3 DEPT001</td> <td style="width: 10%;"></td> <td style="width: 10%; text-align: right;">.3.00</td> <td style="width: 10%;"></td> <td style="width: 10%;"></td> <td style="width: 10%;"></td> </tr> <tr> <td>TL</td> <td style="text-align: right;">- 3.00</td> <td></td> <td></td> <td></td> <td></td> </tr> <tr> <td>CASH</td> <td></td> <td style="text-align: right;">.3.00</td> <td></td> <td></td> <td></td> </tr> </table>			3 DEPT001		.3.00				TL	- 3.00					CASH		.3.00			
3 DEPT001		.3.00																						
TL	- 3.00																							
CASH		.3.00																						

Example 3

OPERATION			RECEIPT																										
	Dept. 3	\$2.00	2	00	3																								
Item 1	Quantity	1	The transaction is not finalized. Because another item is registered before the single item sales department.																										
	Status	Normal																											
Item 2	Dept. 1	(\$1.00)	<table style="width: 100%; border-collapse: collapse;"> <tr> <td style="width: 10%;">1 DEPT003</td> <td style="width: 10%;"></td> <td style="width: 10%; text-align: right;">.2.00</td> <td style="width: 10%;"></td> <td style="width: 10%;"></td> <td style="width: 10%;"></td> </tr> <tr> <td>1 DEPT001</td> <td></td> <td style="text-align: right;">.1.00</td> <td></td> <td></td> <td></td> </tr> <tr> <td>TL</td> <td style="text-align: right;">- 3.00</td> <td></td> <td></td> <td></td> <td></td> </tr> <tr> <td>CASH</td> <td></td> <td style="text-align: right;">.3.00</td> <td></td> <td></td> <td></td> </tr> </table>			1 DEPT003		.2.00				1 DEPT001		.1.00				TL	- 3.00					CASH		.3.00			
1 DEPT003		.2.00																											
1 DEPT001		.1.00																											
TL	- 3.00																												
CASH		.3.00																											
	Quantity	1	<input type="checkbox"/> CA / AMT / TEND																										
	Status	S.I.S																											
Payment	Cash	\$3.00																											

Currency exchange function

When <CE1> or <CE2> key is pressed, a current subtotal including tax is converted directly into foreign currency and the result is displayed, and the subsequent finalization is handled using the foreign currency. The currency exchange function is released by finalizing a transaction, partial tender operation, receipt issuance, or by pressing <SUBTOTAL>.

Before using the currency exchange function, it is necessary to program the conversion rate.

Registering foreign currency

Full amount tender in foreign currency

* Pre-programmed exchange rate: ¥ 100 = \$0.9524

Important!

Tenders in a foreign currency can be registered using the **CA/AMT/TEND** and **CHK** only. Other finalize keys cannot be used.

OPERATION	DISPLAY	RECEIPT														
<p>1 0 00 1 ← Enter the unit price and press the applicable department key.</p>	<p>10.00 (Displays in \$)</p>	<table border="1"> <tr> <td>1 DEPT001</td> <td>· 10.00</td> </tr> <tr> <td>1 DEPT002</td> <td>· 20.00</td> </tr> <tr> <td>TL</td> <td>- 30.00</td> </tr> <tr> <td>CE</td> <td></td> </tr> <tr> <td>CASH</td> <td>¥5,000</td> </tr> <tr> <td>CASH</td> <td>· 47.62</td> </tr> <tr> <td>CG</td> <td>· 17.62</td> </tr> </table>	1 DEPT001	· 10.00	1 DEPT002	· 20.00	TL	- 30.00	CE		CASH	¥5,000	CASH	· 47.62	CG	· 17.62
1 DEPT001	· 10.00															
1 DEPT002	· 20.00															
TL	- 30.00															
CE																
CASH	¥5,000															
CASH	· 47.62															
CG	· 17.62															
<p>2 0 00 2 ← Enter the next unit price and press the applicable department key.</p>	<p>20.00 (Displays in \$)</p>															
<p>CE SUB TOTAL ← Press CE and SUB TOTAL without entering a numeric value. This operation converts the subtotal (including tax) dollar value into yen by applying a pre-programmed exchange rate. The result is shown on the display and printed on the receipt/journal by programming.</p>	<p>3.150 (Displays in ¥: 3,150)</p>															
<p>5 0 00 CE ← Enter the amount tendered in yen and press CE. This operation converts the entered yen amount into dollars by applying a pre-programmed exchange rate. The result is shown on the display. (5,000)</p>	<p>5.000</p>															
<p>CA/AMT/TEND ← Press to finalize the transaction. Note that you do not need to reenter the dollar amount. The register automatically calculates the change amount due in dollars and shows it on the display, receipts and journal.</p>	<p>17.62 (Displays in \$)</p>															

Partial tender in a foreign currency

* Pre-programmed exchange rate: ¥ 100 = \$0.9524

Important!

Partial tender in a foreign currency can be registered using **CA/AMT/TEND** and **CHK** only. Other finalization keys cannot be used, but the remaining tender can be finalized using any finalize key.

OPERATION

DISPLAY

RECEIPT

1 0 00 **1**

← Enter the unit price and press the applicable department key.

10.00
(Displays in \$)

2 0 00 **2**

← Enter the next unit price and press the applicable department key.

20.00
(Displays in \$)

CE **SUB TOTAL**

← Press **CE** and **SUB TOTAL** without entering a numeric value. This operation converts the subtotal (including tax) dollar value into yen by applying a pre-programmed exchange rate. The result is shown on the display and printed on the receipt/journal by programming.

3.150
(Displays in ¥: 3,150)

2 0 00 **CE**
(2,000)

← Enter the partial amount tendered in yen and press **CE**. This operation converts the entered yen amount into dollars by applying a pre-programmed exchange rate. The result is shown on the display.

2.000

CA/AMT/TEND

← Press **CA/AMT/TEND** to specify cash tender for the yen partial tender. Note that you do not need to reenter the dollar amount. The register automatically deducts the dollar equivalent of the yen amount tendered from the total amount due and shows the amount on the display.

10.95
(Displays in \$)

CHK/TEND

← Press to finalize the transaction.

10.95
(Displays in \$)

1	DEPT001	· 10.00
1	DEPT002	· 20.00
	TL	- 30.00
	CE	
	CASH	¥2,000
	CASH	· 19.05
	CHECK	· 10.95

Advanced Operations and Setups

Premium

Example

Item 1	Dept. 1	\$1.00
	Quantity	1
	Premium	10%
Item 2	Dept. 1	\$2.00
	Quantity	3
Subtotal	Premium	(15%)
Payment	Cash	\$8.17

OPERATION

1 **00** **1**
1 **0** **%+**
3 **X** **DATE**
TIME
2 **00** **1**
SUB
TOTAL
%+
CA/AMT
TEND

RECEIPT

1 DEPT001	·1.00
10%	
%+	·0.10
3 DEPT001	·6.00
ST	·7.10
15%	
%+	·1.07
TL	- 8.17
CASH	·8.17

Coupon

Note that errors result when the result of a calculation is negative if the cash register is programmed to prohibit credit balances.

Example

Item 1	Dept. 1	\$3.00
	Quantity	2
	Coupon	\$0.50 × 2
Item 2	Dept. 3	\$4.00
	Quantity	1
	Coupon	(\$1.00)
Payment	Cash	\$8.00

OPERATION

2 **X** **DATE**
TIME
3 **00** **1**
2 **X** **DATE**
TIME
5 **0** **CPN**
4 **00** **3**
CPN
CA/AMT
TEND

RECEIPT

2 DEPT001	·6.00
COUPON	-1.00
1 DEPT003	·4.00
COUPON	-1.00
TL	- 8.00
CASH	·8.00

VAT breakdown printing

You can force printing of the VAT breakdown at the finalize stage, regardless of whether the cash register is programmed to print or skip printing of the VAT breakdown. Every time you want to have VAT breakdown, press <VAT>.

Example

OPERATION			RECEIPT		
Item 1	Dept 1	\$1.00	1 00 1	1 DEPT001 T1	·1.00
	Taxable	1			
Item 2	PLU 1	(\$2.00)	1 PLU	TA1	·0.90
	Taxable	2		TX1	·0.10
Payment	Cash	\$3.00	VAT	TA2	·1.90
				CA / AMT / TEND	TX2
				TL	- 3.00
				CASH	·3.00

Programming department / PLU descriptors and preset messages in the list

In this chapter, the procedures to choose department / PLU descriptors and preset messages from the preset list are described. Read help receipt, so that you can set the descriptors and messages easily.

How to choose and set the department / PLU descriptors in the list

1. Turn to the PGM mode.
2. Enter **0 7** and press the **HELP** key.
3. Select the item name and follow these steps in the list.

How to choose and set the preset receipt message and graphic logo in the list

1. Turn to the PGM mode.
2. Enter **0 8** and press the **HELP** key. (Programming procedure and Preset message list is issued.)
3. Follow these steps in the list.

Preset message and graphic print sample

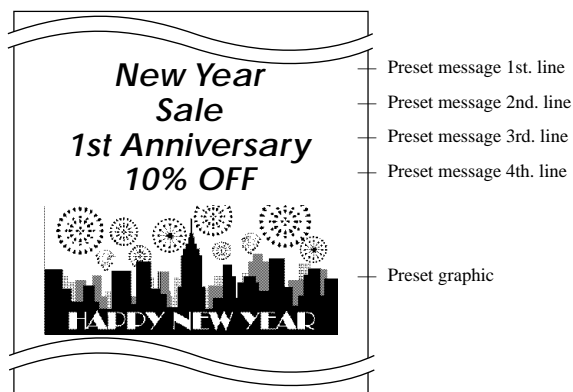

Character manual input

This chapter shows the procedures to program department / PLU descriptors, store messages, key descriptors, report title, total descriptor (such as gross total, net total...) and clerk name.

The characters you entered by the character keyboard or multi-tapping keyboard, can be programmed.

The “Entering characters” section shows how to enter characters, and the “Programming descriptors and messages by entering characters” shows how to program the entered characters to each memory.

Entering characters

In this section, the method to enter descriptors or messages (characters) to the cash register during programming is described.

Characters are specified by character keyboard or by multi tapping method. In the first half of this section, the usage of character keyboard is described. In the latter half, inputting method by multi tapping is described.

Using character keyboard

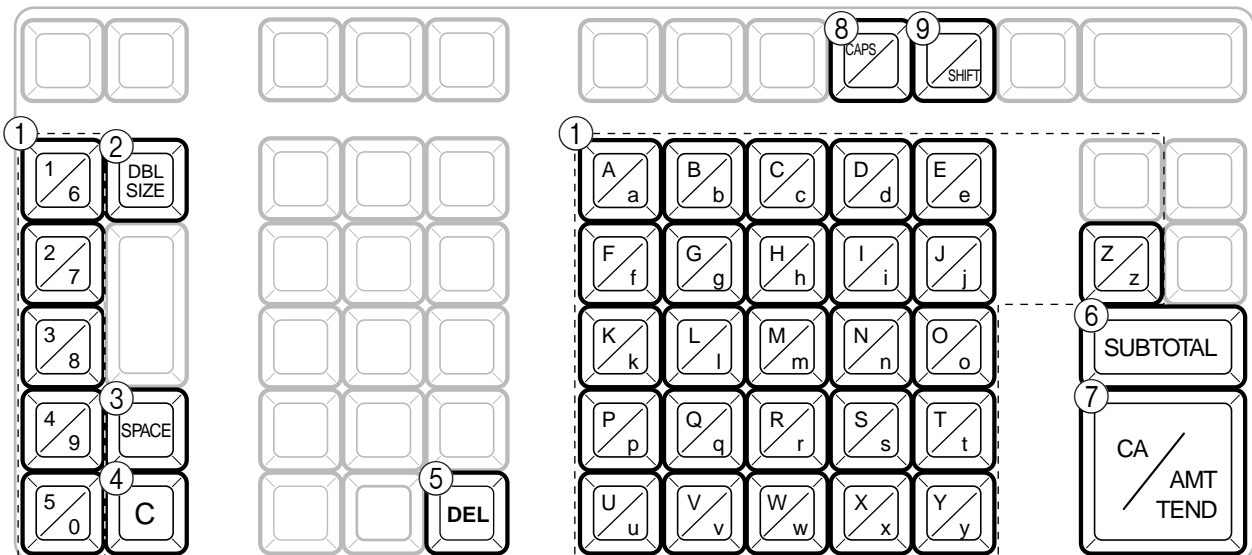

① **Alphabet keys**

Used input to characters.

② **Double size letter key**

Specifies that the next characters you input to double size characters. After completion of inputting double size character, press this key for normal size character.

③ **Space key**

Set a space by depression.

④ **Clear key**

Clears all input characters in the programming.

⑤ **Delete key**

Clears the last input character, much like a back space key.

Example:

Input “ **A** p p l e J u i c e ”,
 enter <DBL><A> <DBL><Shift><p> <p> <l> <e> <Space> <CAPS><J> <Shift><u> <i> <c> <e> .

⑥ **Program end key**

Terminates the character programming.

⑦ **Character enter key**

Registers the programmed characters.

⑧ **CAPS key**

Pressing this key shifts the character from the lowercase letter to upper case letter.

⑨ **Shift key**

Pressing this key shifts the character from the uppercase letter to lower case letter.

Entering characters by multi tapping

When you enter characters by this method, you need to press each key repeatedly until the desired character appears.

Multi tapping keyboard

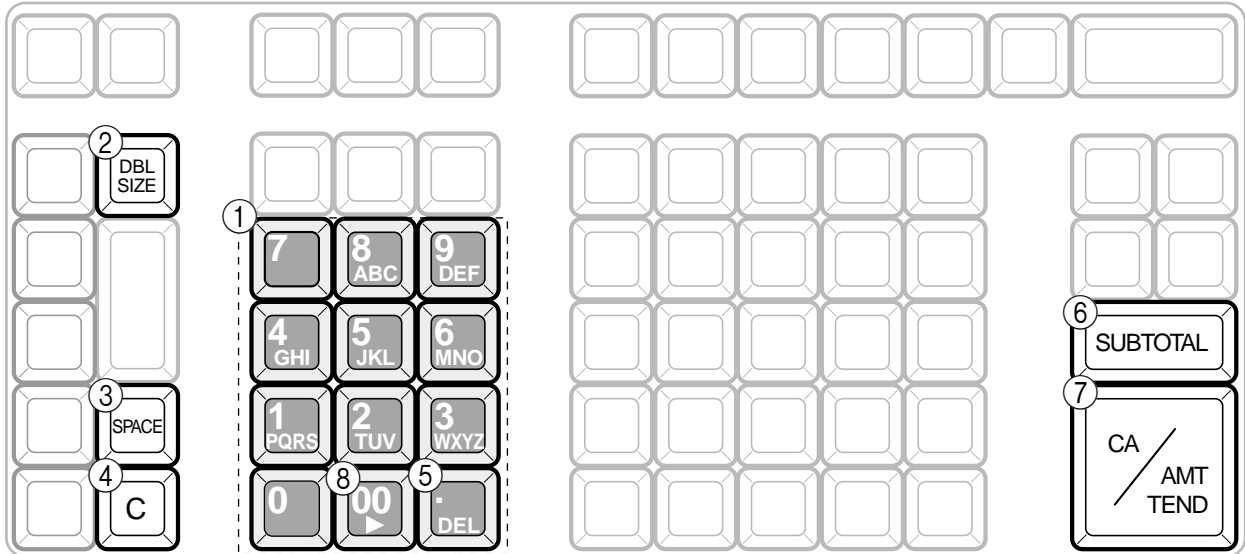

① Alphabet keys

Used input to characters.

Key	Text
7	7 @ - / : ! ? " () * # + , ^ ; < = > \$ ¥ % & [] ' { } . " . \ _ ' ¢ x ÷ ï € § (space) □
8	A B C a b c 8 Ä Å Æ Á Â Ã Ç â ä à á æ á ã ç □
9	D E F d e f 9 ð É Ê Ë È Æ é ê ë è f
4	G H I g h i 4 Í Î Ï Ì Ñ ï í 1
5	J K L j k l 5
6	M N O m n o 6 Ñ Ò ø Ó Ô Õ Ö ñ ô ö ò φ ó õ □
1	P Q R S p q r s 1 P Þ ß
2	T U V t u v 2 Ú Û Ü Û Ü Û ù ú μ
3	W X Y Z w x y z 3 Ÿ ŷ ŷ
0	0
00	(Right cursor)
.	(Delete)

② Double size letter key

Specifies that the next characters you input to double size characters. After completion of inputting double size character, press this key for normal size character.

③ Space key

Set a space by depression.

④ Clear key

Clears all input characters in the programming.

⑤ Delete key

Clears the last input character, much like a back space key.

⑥ Program end key

Terminates the character programming.

⑦ Character enter key

Registers the programmed characters.

⑧ Right cursor key

Move the cursor to the right by one to enter a character on the same tapping key.

Example:

Input “ C L A S S a ” ,
enter “ <DBL> 8 8 8 5 5 5 <DBL> 8 1 1 1 1 00 1 1 1 1 <Space> 8 8 8 8 ” .

Programming descriptors and messages by entering characters

The following descriptors and messages can be programmed;

- Report descriptor (such as gross total, net total, cash in drawer...)
- Grand total
- Special character (such as mode symbol, taxable symbol...)
- Read/reset report title
- Clerk name
- PLU item descriptor
- Messages (Logo, commercial and bottom message)
- Function key descriptor
- Department key descriptor

Programming PLU descriptor

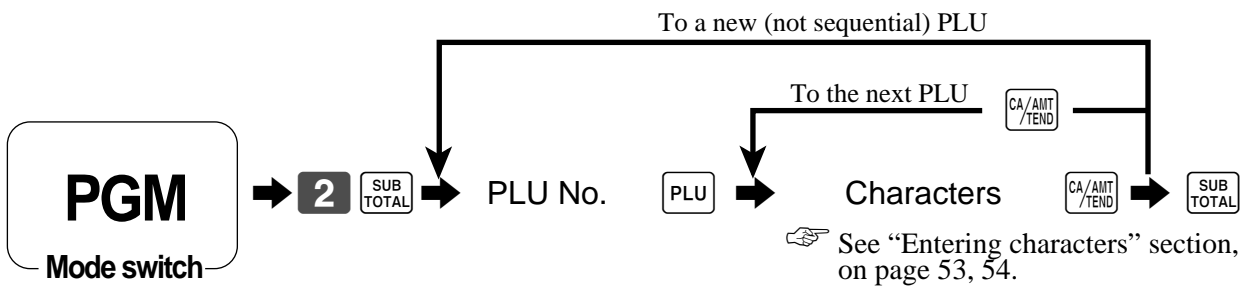

PLU No.	Contents	Initial character	Yours																				
0001	PLU0001	PLU0001																					
0002	PLU0002	PLU0002																					
0003	PLU0003	PLU0003																					
0004	PLU0004	PLU0004																					
0005	PLU0005	PLU0005																					
0006	PLU0006	PLU0006																					
0007	PLU0007	PLU0007																					
0008	PLU0008	PLU0008																					
0009	PLU0009	PLU0009																					
0010	PLU0010	PLU0010																					
0011	PLU0011	PLU0011																					
0012	PLU0012	PLU0012																					
0013	PLU0013	PLU0013																					
0014	PLU0014	PLU0014																					
0015	PLU0015	PLU0015																					
0016	PLU0016	PLU0016																					
0017	PLU0017	PLU0017																					
0018	PLU0018	PLU0018																					
0019	PLU0019	PLU0019																					
0020	PLU0020	PLU0020																					
0021	PLU0021	PLU0021																					
0022	PLU0022	PLU0022																					
0023	PLU0023	PLU0023																					
0024	PLU0024	PLU0024																					
0025	PLU0025	PLU0025																					
0026	PLU0026	PLU0026																					
0027	PLU0027	PLU0027																					
0028	PLU0028	PLU0028																					
0029	PLU0029	PLU0029																					
0030	PLU0030	PLU0030																					

Advanced Operations and Setups

Programming department / function key descriptor

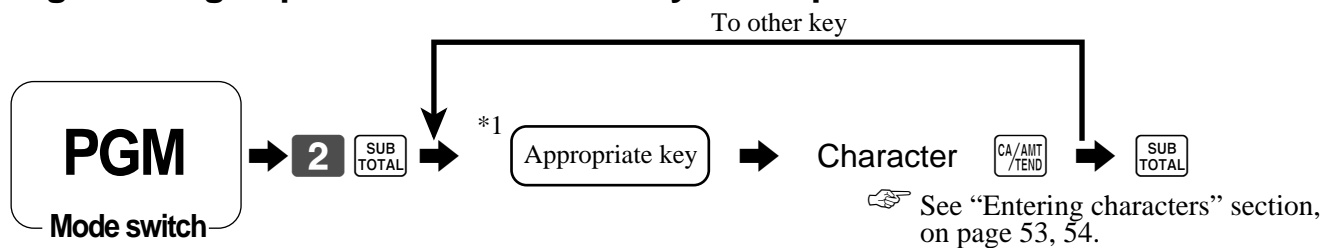

*1 Appropriate key: In case of shifting department, press <DEPT SHIFT> key first.

Function key

Contents	Initial character	Yours									
Cash/amount tendered	CASH										
Charge	CHARGE										
Check	CHECK										
Received on account	RC										
Paid out	PD										
Minus	-										
Discount	%-										
Premium	%+										
Receipt on/off	RCT ON/OFF										
Post receipt	RCT										
Refund	RF										
Error correct/Cancel	CORR										
Sign off	SIGN-OFF										
Open	OPEN										
Department shift	SHIFT/No										
Multiplication/Date time	X										
Coupon	COUPON										
VAT	VAT										
Non-add	#										
No sale	NS										
Currency exchange 1	CE 1										
Currency exchange 2	CE 2										

Department key

Contents	Initial character	Yours									
Department 001	DEPT001										
Department 002	DEPT002										
Department 003	DEPT003										
Department 004	DEPT004										
Department 005	DEPT005										
Department 006	DEPT006										
Department 007	DEPT007										

Programming message

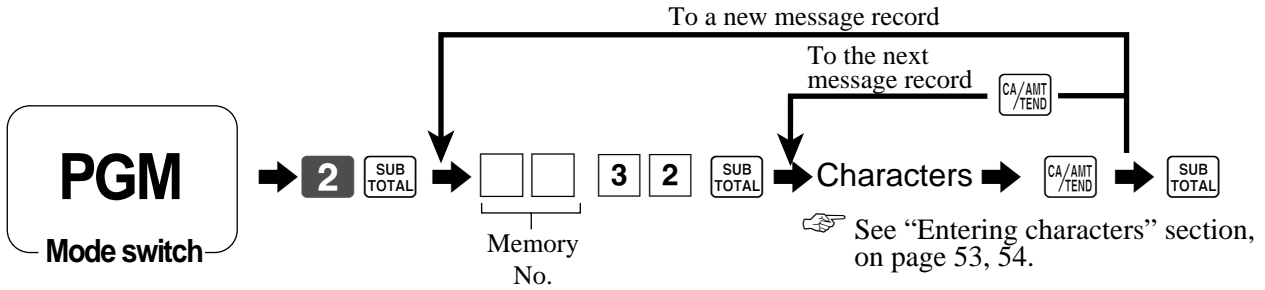

Receipt message

Refer to “(message control)” on page 64.

Memory No.	Contents	Initial character	Yours
01	1st line of logo message	YOUR RECEIPT	
02	2nd line of logo message	THANK YOU	
03	3rd line of logo message	CALL AGAIN	
04	4th line of logo message		
05	1st line of commercial message		
06	2nd line of commercial message		
07	3rd line of commercial message		
08	4th line of commercial message		
09	1st line of bottom message		
10	2nd line of bottom message		
11	3rd line of bottom message		
12	4th line of bottom message		
:	:		
25	(not used)	DUPLICATE RECEIPT	
:	:		
40	Australian GST message 1st. line	TAX INVOICE	
41	Australian GST message 2nd. line	* INDICATES	
42	Australian GST message 3rd. line	TAXABLE SUPPLY	

Programming Clerk name

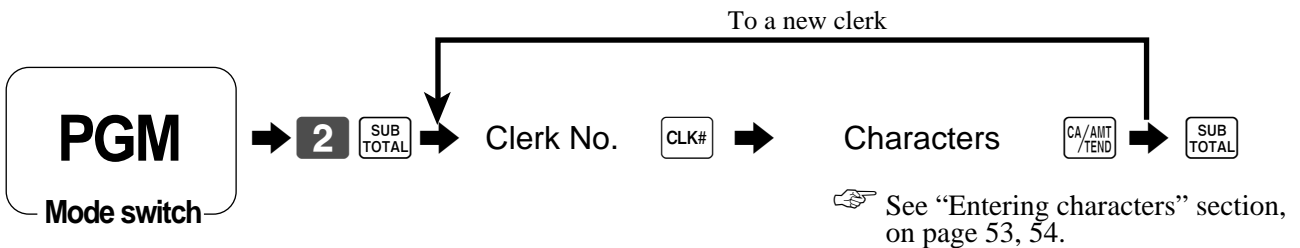

Clerk name

Clerk No.	Contents	Initial character	Yours
01	Clerk 01	C01	
02	Clerk 02	C02	
03	Clerk 03	C03	
04	Clerk 04	C04	

Grand total, special character

Memory No.	Program code	Contents	Initial character	Yours	
01	23	main currency symbol (2), @ (2), No. (2), split pricing (2), not used (4), sub currency symbol (2)		· @ N o / * * €	
02		No. of item sold (2), No. of customer (2), not used (6), multiplication display (2)	N	o C T @ L B * Q T	
03		multiplication (6) not used (6)	X	· B U S Y	
04		taxable symbol 1 (3 each) for tax 1, tax 2, tax 3, tax 4	T	1 T 2 T 3 T 4 T 5	
06		taxable symbol 3 (3 each) for tax 1/2, tax 1/3, not used, not used, tax 2/3	T	1 2 T 1 3 T 1 4 T 2 3	
08		foreign currency (2 each), not used (8)	*	* * * * *	
09		mode symbol 1 (4 each) REG1/2, RF, not used	REG	R F R	
10		mode symbol 2 (4 each) PGM, Daily X, Daily Z, Periodic	P	X Z X Z	
11		mode symbol 3 (4 each) not used, PGM read	T	R G P G M X	
12		decimal: amount/q'ty, separator (main/sub) (1 each), not used (3), square (7)	.	· · · · · · X	
13		A.M., P.M. (3 each), ST displayed on the dot display (2)	'	A M ' P M ' S T	
16		display subtotal symbol (ST key) (16)	S	T	
17		subtotal discount / premium symbol (16)	S	T	
18		post receipt total symbol (16)	T	L	
19		change symbol (16)	C	G	
01		20	Grand total (16)	G	T

Report title

Memory No.	Program code	Contents	Initial character	Yours
01	24	Fixed total report title	FIX	
02		Transaction key report title	TRANS	
03		PLU sales report title	PLU	
04		Department sales report title	DEPT	
05		Group sales report title	GROUP	
06		Clerk sales report title	CASHIER	
08		Hourly sales report title	HOURLY	
09		Monthly sales report title	MONTHLY	
16		Financial report title	FLASH	

Machine feature program

General control program

Programming procedure

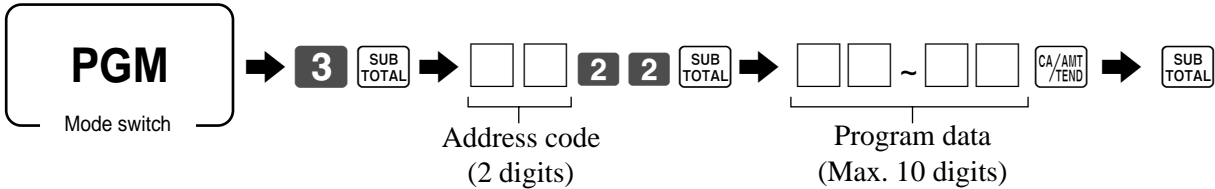

Program data (by address code)

Address code 02 (machine number)

Description	Choice	Program code	Initial value
Machine number	Significant numbers	<input type="text"/> <input type="text"/> <input type="text"/> <input type="text"/> D ₄ D ₃ D ₂ D ₁	<input type="text"/> <input type="text"/> <input type="text"/> <input type="text"/> 0 0 0 0 D ₄ D ₃ D ₂ D ₁

Address code 03 (consecutive number)

Description	Choice	Program code	Initial value
Reset consecutive number after daily reset report is issued.	Yes = 0 No = 1	<input type="text"/> D ₈	<input type="text"/> 0 D ₈
Always "00000000"		<input type="text"/> ~ <input type="text"/> D ₇ ~ D ₁	<input type="text"/> ~ <input type="text"/> 0 ~ 0 D ₇ ~ D ₁

Address code 04 (tax system, rounding)

Description	Choice	Program code	Initial value
Apply rounding for registration. No rounding = 0, IF1 = 1, IF2 = 2, Danish = 3, Norwegian = 4, Singaporean = 5 Finnish = 6, Australian = 7, South African = 8, Other roundings = 9 (Refer to D ₁)	Significant number (0 ~ 9)	<input type="text"/> D ₁₀	<input type="text"/> 0 D ₁₀
Tax system Single tax system (1 ~ 4) = 0, Singaporean tax system = 3	Significant number	<input type="text"/> D ₉	<input type="text"/> 0 D ₉
Always "00000000"		<input type="text"/> ~ <input type="text"/> D ₈ ~ D ₂	<input type="text"/> ~ <input type="text"/> 0 ~ 0 D ₈ ~ D ₂
Other roundings: New Zealander (A) = 0, New Zealander (B) = 1 (D ₁₀ must be set to "9".)	Significant number (0 ~ 1)	<input type="text"/> D ₁	<input type="text"/> 0 D ₁

Rounding

IF 1 rounding		Danish rounding		Singaporean rounding		Australian rounding	
Last 1 digit of ST	Result	Last 2 digit of ST/CA CG	Result	Last 1 digit of item, %+, %- REG	Result	Last 1 digit of ST/CA CG	Result
0 ~ 2	0	00 ~ 12	00	0 ~ 2	0	0 ~ 2	0
3 ~ 7	5	13 ~ 37	25	3 ~ 7	5	3 ~ 7	5
8 ~ 9	10	38 ~ 62	50	8 ~ 9	10	8 ~ 9	10
IF 2 rounding		Norwegian rounding		Finnish rounding		South African rounding	
Last 1 digit of ST	Result	Last 1 digit of ST	Result	Last 2 digit of ST/CA CG	Result	Last 1 digit of ST	Result
0 ~ 4	0	00 ~ 24	0	0 ~ 2	0	0 ~ 4	0
5 ~ 9	10	25 ~ 74	50	3 ~ 7	5	5 ~ 9	5
		75 ~ 99	100	8 ~ 9	10		
				New Zealander (A/B) rounding			
				Last 1 digit of ST/CA CG	Result		
				0 ~ 4/5	0		
				5/6 ~ 9	10		

Address code 05 (print control for receipt)

Description		Choice	Program code	Initial value
Print total line during finalization.	a	Yes = 0 No = 1	<input type="checkbox"/>	<input type="checkbox"/> 0
Time system: ① 24 hour system, ② 12 hour system	b	① = 0 ② = 2	(a+b) D ₁₀	(a+b) D ₁₀
Buffered receipt print *1		No = 0 Yes = 2	<input type="checkbox"/> D ₉	<input type="checkbox"/> D ₉
Skip item lines on journal. (journal skip)		No = 0 Yes = 1	<input type="checkbox"/> D ₈	<input type="checkbox"/> D ₈
Always "000"			<input type="checkbox"/> <input type="checkbox"/> <input type="checkbox"/> D ₇ D ₆ D ₆	<input type="checkbox"/> <input type="checkbox"/> <input type="checkbox"/> D ₇ D ₆ D ₅
Print number of item sold. (item counter)	a	No = 0 Yes = 1	<input type="checkbox"/>	<input type="checkbox"/> 2
Print tax symbols.	b	Yes = 0 No = 2	(a+b) D ₄	(a+b) D ₄
Always "00"			<input type="checkbox"/> <input type="checkbox"/> D ₃ D ₂	<input type="checkbox"/> <input type="checkbox"/> D ₃ D ₂
Always "0".			<input type="checkbox"/> D ₁	<input type="checkbox"/> D ₁

*1: Select "Yes" if you want to print receipts with watermarks.
D₄ becomes "0", after activating Australian GST.

Address code 06 (calculation & operation control)

Description		Choice	Program code	Initial value
Follow the taxable status and commission status of previous item when +/- operation is performed.	a	Yes = 0 No = 1	<input type="checkbox"/>	<input type="checkbox"/> 0
Force a money declaration before read/reset operation.	b	No = 0 Yes = 4	(a+b) D ₁₀	(a+b) D ₁₀
Force to press <input type="button" value="SUB TOTAL"/> before finalization	a	No = 0 Yes = 1		
Allow credit balance while finalization.	b	Yes = 0 No = 2	<input type="checkbox"/> (a+b+c) D ₉	<input type="checkbox"/> (a+b+c) D ₉
Allow multiple refund operation.	c	Yes = 0 No = 4		
Affect the result of +/-, %+/%- to the item. (Net totalling)		No = 0 Yes = 1	<input type="checkbox"/> D ₈	<input type="checkbox"/> D ₈
Include commission in net total.		Yes = 0 No = 2	<input type="checkbox"/> D ₇	<input type="checkbox"/> D ₇
Clear the key buffer when a receipt is issued. (REG mode only)	a	No = 0 Yes = 1		
Sounds key catch tone.	b	Yes = 0 No = 2	<input type="checkbox"/> (a+b+c) D ₆	<input type="checkbox"/> (a+b+c) D ₆
Allow to issue post receipt, even if the original one is issued.	c	No = 0 Yes = 4		
Always "00"			<input type="checkbox"/> <input type="checkbox"/> D ₅ D ₄	<input type="checkbox"/> <input type="checkbox"/> D ₅ D ₄
Always "0"			<input type="checkbox"/> D ₃	<input type="checkbox"/> D ₃
Use <00> key as <000> key.		<00> = 0 <000> = 4	<input type="checkbox"/> D ₂	<input type="checkbox"/> D ₂
Always "0".			<input type="checkbox"/> D ₁	<input type="checkbox"/> D ₁

Advanced Operations and Setups

Address code 08 (print control for fixed total report)

Description		Choice	Program code	Initial value
Print gross sales total on fixed total report (GROSS)	a	Yes = 0 No = 1	<input type="checkbox"/> (a+b+c) D ₁₀	<input type="checkbox"/> 0 (a+b+c) D ₁₀
Print net sales total on fixed total report (NET)	b	Yes = 0 No = 2		
Print cash in drawer total on fixed total report (CAID)	c	Yes = 0 No = 4		
Print charge in drawer total on fixed total report (CHID)		Yes = 0 No = 2	<input type="checkbox"/> D ₉	<input type="checkbox"/> 0 D ₉
Print check in drawer total on fixed total report (CKID)	a	Yes = 0 No = 1	<input type="checkbox"/> (a+b) D ₈	<input type="checkbox"/> 0 (a+b) D ₈
Print credit in drawer total on fixed total report (CRID(1) ~ (4))	b	Yes = 0 No = 4		
Always "0"			<input type="checkbox"/> 0 D ₇	<input type="checkbox"/> 0 D ₇
Print RF mode total on fixed total report (RF)		Yes = 0 No = 4	<input type="checkbox"/> D ₆	<input type="checkbox"/> 0 D ₆
Print the net number of customers on fixed total report (CUST)	a	Yes = 0 No = 1	<input type="checkbox"/> (a+b) D ₅	<input type="checkbox"/> 2 (a+b) D ₅
Print the average sales per customer on fixed total report (AVER)	b	Yes = 0 No = 2		
Always "0"			<input type="checkbox"/> 0 D ₄	<input type="checkbox"/> 0 D ₄
Print commission 1 total on fixed total report (C-1)	a	Yes = 0 No = 1	<input type="checkbox"/> (a+b+c) D ₃	<input type="checkbox"/> 7 (a+b+c) D ₃
Print commission 2 total on fixed total report (C-2)	b	Yes = 0 No = 2		
Print foreign currency cash in drawer and check in drawer totals on fixed total report (CECA1 ~ 2, CECK1 ~ 2)	c	Yes = 0 No = 4		
Print <MINUS>, <COUPON>, <%-> and mix & match operation net total on fixed total report (DC)	a	Yes = 0 No = 1	<input type="checkbox"/> (a+b+c) D ₂	<input type="checkbox"/> 3 (a+b+c) D ₂
Print <REFUND> and <VOID> operation net total on fixed total report (REF)	b	Yes = 0 No = 2		
Print nontaxable totals on fixed total report (NON TAX)	a	Yes = 0 No = 1	<input type="checkbox"/> (a+b+c) D ₁	<input type="checkbox"/> 3 (a+b+c) D ₁
Print rounding totals on fixed total report (ROUND)	b	Yes = 0 No = 2		
Print cancellation total on fixed total report (CANCEL)	c	Yes = 0 No = 4		

Preset value becomes "0527327771", after activating Australian GST.

Address code 10 (print control for taxable amount)

Description		Choice	Program code	Initial value
Print taxable amount 1 on receipt/journal.	a	Yes = 0 No = 1	<input type="checkbox"/> (a+b+c) D ₁₀	<input type="checkbox"/> 0 (a+b+c) D ₁₀
Print taxable amount 2 on receipt/journal.	b	Yes = 0 No = 2		
Print taxable amount 3 on receipt/journal.	c	Yes = 0 No = 4		
Print taxable amount 4 on receipt/journal.		Yes = 0 No = 1	<input type="checkbox"/> D ₉	<input type="checkbox"/> 0 D ₉
Always "00000000"			<input type="checkbox"/> ~ <input type="checkbox"/> D ₈ ~ D ₁	<input type="checkbox"/> ~ <input type="checkbox"/> D ₈ ~ D ₁

Address code 14 (currency exchange control)

Description		Choice	Program code	Initial value
Monetary mode of CECA1 and CECK1 in fixed total report:		Significant number (0 ~ 9)	<input type="checkbox"/> D ₈	<input type="checkbox"/> D ₈
Decimal for CECA1 and CECK1 in fixed total report: ① Period = 0, ② Comma = 1	a	① = 0 ② = 1	<input type="checkbox"/> (a+b) D ₇	<input type="checkbox"/> (a+b) D ₇
Separator for CECA1 and CECK1 in fixed total report: ① Comma = 0, ② Period = 1	b	① = 0 ② = 4		
Monetary mode of CECA2 and CECK2 in fixed total report:		Significant number (0 ~ 9)	<input type="checkbox"/> D ₆	<input type="checkbox"/> D ₆
Decimal for CECA2 and CECK2 in fixed total report: ① Period = 0, ② Comma = 1	a	① = 0 ② = 1	<input type="checkbox"/> (a+b) D ₅	<input type="checkbox"/> (a+b) D ₅
Separator for CECA2 and CECK2 in fixed total report: ① Comma = 0, ② Period = 1	b	① = 0 ② = 4		
Always "0000"			<input type="checkbox"/> <input type="checkbox"/> <input type="checkbox"/> <input type="checkbox"/> D ₄ D ₃ D ₂ D ₁	<input type="checkbox"/> <input type="checkbox"/> <input type="checkbox"/> <input type="checkbox"/> D ₄ D ₃ D ₂ D ₁

Address code 15 (print control for reports)

Description		Choice	Program code	Initial value
Zero skip department report.	a	Yes = 0 No = 1	<input type="checkbox"/> (a+b) D ₁₀	<input type="checkbox"/> (a+b) D ₁₀
Zero skip clerk report.	b	Yes = 0 No = 2		
Zero skip transaction report.	a	Yes = 0 No = 1	<input type="checkbox"/> (a+b+c) D ₉	<input type="checkbox"/> (a+b+c) D ₉
Zero skip PLU report.	b	Yes = 0 No = 2		
Zero skip hourly report.	c	Yes = 0 No = 4		
Zero skip group report.		Yes = 0 No = 1	<input type="checkbox"/> D ₈	<input type="checkbox"/> D ₈
Always "00"			<input type="checkbox"/> <input type="checkbox"/> D ₇ D ₆	<input type="checkbox"/> <input type="checkbox"/> D ₇ D ₆
Print PLU number on the PLU report.		No = 0 Yes = 4	<input type="checkbox"/> D ₅	<input type="checkbox"/> D ₅
Print sales ratio.	a	No = 0 Yes = 1	<input type="checkbox"/> (a+b) D ₄	<input type="checkbox"/> (a+b) D ₄
Issue double Z report.	b	No = 0 Yes = 2		
Always "000"			<input type="checkbox"/> <input type="checkbox"/> <input type="checkbox"/> D ₃ D ₂ D ₁	<input type="checkbox"/> <input type="checkbox"/> <input type="checkbox"/> D ₃ D ₂ D ₁

Address code 16 (print control for grand total)

Description		Choice	Program code	Initial value
Print consecutive number range of the day on daily fixed total report.		No = 0 Yes = 1	<input type="checkbox"/> D ₇	<input type="checkbox"/> D ₇
Always "00000"			<input type="checkbox"/> <input type="checkbox"/> <input type="checkbox"/> <input type="checkbox"/> D ₆ ~ D ₂	<input type="checkbox"/> <input type="checkbox"/> <input type="checkbox"/> <input type="checkbox"/> D ₆ ~ D ₂
Print grand total on daily sales reset report.		Yes = 0 No = 1	<input type="checkbox"/> D ₁	<input type="checkbox"/> D ₁

Advanced Operations and Setups

Address code 17 (print control)

Description		Choice	Program code	Initial value
Print date on journal.	a	Yes = 0 No = 2	<input type="checkbox"/>	<input type="checkbox"/> 0
Print consecutive number on receipt/journal.	b	Yes = 0 No = 4	(a+b) D ₄	(a+b) D ₄
Print time on receipt.	a	Yes = 0 No = 1	<input type="checkbox"/>	<input type="checkbox"/> 0
Print time on journal.	b	Yes = 0 No = 2	(a+b) D ₃	(a+b) D ₃
Always "00"			<input type="checkbox"/> <input type="checkbox"/> D ₂ D ₁	<input type="checkbox"/> <input type="checkbox"/> D ₂ D ₁

Address code 19 (receipt control)

Description	Choice	Program code	Initial value
Print receipt in double-height characters.	No = 0 Yes = 1	<input type="checkbox"/> D ₇	<input type="checkbox"/> 0 D ₇
Always "000000"		<input type="checkbox"/> 0 ~ <input type="checkbox"/> 0 D ₆ ~ D ₁	<input type="checkbox"/> 0 ~ <input type="checkbox"/> 0 D ₆ ~ D ₁

Address code 21 (message control)

Description		Choice	Program code	Initial value
Print graphic type logo. (If select "No", character type logo is printed.)	a	No = 0 Yes = 2	<input type="checkbox"/>	<input type="checkbox"/> 0
Print watermark on receipt.	b	Yes = 0 No = 4	(a+b) D ₁₀	(a+b) D ₁₀
Always "000"			<input type="checkbox"/> 0 <input type="checkbox"/> 0 <input type="checkbox"/> 0 D ₉ D ₈ D ₇	<input type="checkbox"/> 0 <input type="checkbox"/> 0 <input type="checkbox"/> 0 D ₉ D ₈ D ₇
Print commercial message on receipts in REG/RF mode.	a	No = 0 Yes = 1	<input type="checkbox"/>	<input type="checkbox"/> 0
Print bottom message on receipts in REG/RF mode.	b	No = 0 Yes = 2	(a+b) D ₆	(a+b) D ₆
Always "0000"			<input type="checkbox"/> 0 <input type="checkbox"/> 0 <input type="checkbox"/> 0 <input type="checkbox"/> 0 D ₅ D ₄ D ₃ D ₂	<input type="checkbox"/> 0 <input type="checkbox"/> 0 <input type="checkbox"/> 0 <input type="checkbox"/> 0 D ₅ D ₄ D ₃ D ₂
Print Australian GST MOF message.		No = 0 Yes = 4	<input type="checkbox"/> D ₁	<input type="checkbox"/> 0 D ₁

Address code 25 (entry restriction)

Description	Choice	Program code	Initial value
Restrict (to 0 or 5) on the last one digit for amount tender.	a	<input type="checkbox"/>	<input type="checkbox"/> 0
Restriction (to 0 or 5) on the last one digit for <CASH>, <RC>, <PD>, money declaration amount.	b	(a+b) D ₁	(a+b) D ₁

D₁ becomes "4", after activating Australian GST.

Address code 27 (clerk control)

Description	Choice	Program code	Initial value
Enable clerk function.	No = 0 Yes = 4	<input type="checkbox"/> D ₉	<input type="checkbox"/> 0 D ₉
Always "00000000"		<input type="checkbox"/> 0 ~ <input type="checkbox"/> 0 D ₈ ~ D ₁	<input type="checkbox"/> 0 ~ <input type="checkbox"/> 0 D ₈ ~ D ₁

Address code 28 (Euro 1)

Description	Choice	Program code	Initial value
Define Euro as the main currency.	Yes = 0 No = 1	<input type="checkbox"/> D ₁₀	<input type="checkbox"/> 0 D ₁₀
Select rounding option: Round off = 0, Cut off = 1, Round up = 2	Significant number (0 ~ 2)	<input type="checkbox"/> D ₉	<input type="checkbox"/> 0 D ₉
Exchange rate (within 6-digits)	Significant numbers	<input type="checkbox"/> <input type="checkbox"/> <input type="checkbox"/> <input type="checkbox"/> <input type="checkbox"/> <input type="checkbox"/> D ₈ D ₇ D ₆ D ₅ D ₄ D ₃	<input type="checkbox"/> 0 <input type="checkbox"/> 0 <input type="checkbox"/> 0 <input type="checkbox"/> 0 <input type="checkbox"/> 0 <input type="checkbox"/> 0 D ₈ D ₇ D ₆ D ₅ D ₄ D ₃
Decimal point position of exchange rate: Integer only = 0 1st decimal place = 1, 2nd decimal place = 2, 3rd decimal place = 3, 4th decimal place = 4, 5th decimal place = 5, 6th decimal place = 6 Example: (D8 ~ D2) 1 Euro = 1.977 DM; Set "0019773" 1 Euro = 1957.77319 Lit; Set "1957772"	Significant number (0 ~ 6)	<input type="checkbox"/> D ₂	<input type="checkbox"/> 0 D ₂
Always "0"		<input type="checkbox"/> 0 D ₁	<input type="checkbox"/> 0 D ₁

Address code 29 (Euro 2)

Description	Choice	Program code	Initial value
Monetary mode of sub currency: 0 = 0, 0.0 = 1, 0.00 = 2, 0.000 = 3	Significant number (0 ~ 3)	<input type="checkbox"/> D ₁₀	<input type="checkbox"/> 2 D ₁₀
Apply rounding for sub currency. * No rounding = 0, IF1 = 1, IF2 = 2, Danish = 3, Norwegian = 4, Finnish = 6 Australia = 7, South Africa = 8	Significant number (0 ~ 8)	<input type="checkbox"/> D ₉	<input type="checkbox"/> 0 D ₉
Always "0"		<input type="checkbox"/> 0 D ₈	<input type="checkbox"/> 0 D ₈
Print tendered amount in sub currency converted to main currency.	a No = 0 Yes = 1	<input type="checkbox"/> (a+b+c) D ₇	<input type="checkbox"/> 0 (a+b+c) D ₇
Selection of the currency of subtotal printout: ① Main currency only, ② Main and sub currency	b ① = 0 ② = 2		
Print total in sub currency by double sized letter.	c No = 0 Yes = 4		
Selection of the currency of change: ① Main currency, ② Sub currency	a ① = 0 ② = 1	<input type="checkbox"/> (a+b+c) D ₆	<input type="checkbox"/> 0 (a+b+c) D ₆
Print the cash in drawer of sub currency on fixed total reports. (If the cash in drawer of main currency is skipped, this line is also skipped.)	b No = 0 Yes = 2		
Display symbol of sub currency: ① € (Euro), ② ₣ (Local)	c ① = 0 ② = 4		
The currency to restrict (to 00, 25, 50, 75) on last two digits for amount tendered: ① Main currency, ② Sub currency (It is necessary to set this restriction to <CASH> key.)	a ① = 0 ② = 1	<input type="checkbox"/> (a+b+c) D ₅	<input type="checkbox"/> 0 (a+b+c) D ₅
Print rounding total of sub currency on fixed totalier report.	b No = 0 Yes = 2		
Last 1 digit for sub currency monetary amount entries to 0 or 5.	c No = 0 Yes = 4		
Selection of the change amount printout: ① Main and sub currency, ② Dependent upon D ₆ - a of this worksheet	a ① = 0 ② = 1	<input type="checkbox"/> (a+b) D ₄	<input type="checkbox"/> 0 (a+b) D ₄
Calculation method of change amount in sub currency: ① Convert the change amount in main currency into sub currency. ② Subtract the equivalent value of subtotal amount in sub currency from the equivalent value of the tendered amount in sub currency.	b ① = 0 ② = 2		
Always "000"		<input type="checkbox"/> 0 <input type="checkbox"/> 0 <input type="checkbox"/> 0 D ₃ D ₂ D ₁	<input type="checkbox"/> 0 <input type="checkbox"/> 0 <input type="checkbox"/> 0 D ₃ D ₂ D ₁

* Refer to the Address code 04 programming.

Advanced Operations and Setups

Address code 30 (thermal printer control)

Description		Choice	Program code	Initial value
Print preset receipt message and graphic	a	No = 0 Yes = 1	<input type="checkbox"/>	<input type="checkbox"/> 0
Print preset receipt message and graphic: ① at the bottom of the receipt / ② at the top of the receipt	b	① = 0 ② = 2	(a+b) D ₅	(a+b) D ₅
Journal compressed print (print by half height characters)		Yes = 0 No = 1	<input type="checkbox"/> D ₄	<input type="checkbox"/> D ₄
Always "000"			<input type="checkbox"/> <input type="checkbox"/> <input type="checkbox"/> D ₃ D ₂ D ₁	<input type="checkbox"/> <input type="checkbox"/> <input type="checkbox"/> D ₃ D ₂ D ₁

Address code 34 (backlight control)

Description		Choice	Program code	Initial value
Backlight		Available = 0 Not available = 1	<input type="checkbox"/> D ₄	<input type="checkbox"/> D ₄
Always "000"			<input type="checkbox"/> <input type="checkbox"/> <input type="checkbox"/> D ₃ D ₂ D ₁	<input type="checkbox"/> <input type="checkbox"/> <input type="checkbox"/> D ₃ D ₂ D ₁

Key function program

Department key/PLU program (Batch feature programming)

Programming procedure

Department key

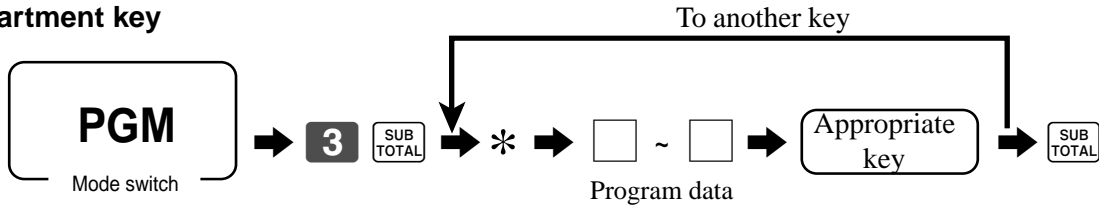

*: In case of shifting department, press <DEPT SHIFT> key first.

PLU

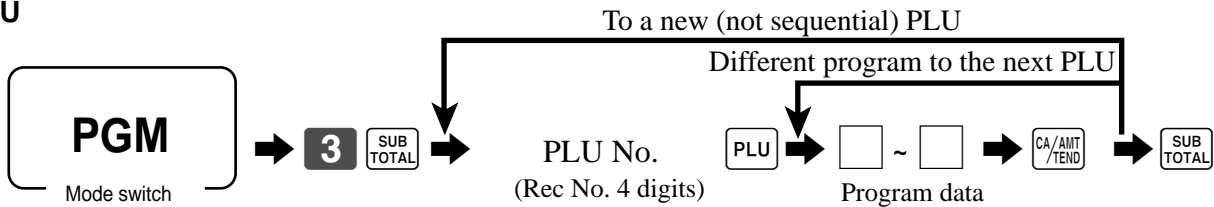

Program data

Description		Choice	Program code	Initial value
Single item control: Normal receipt = 0, Single item receipt = 3		Significant number	<input type="text"/> D ₁₂	<input type="text"/> D ₁₂
Always "0"			<input type="text"/> D ₁₁	<input type="text"/> D ₁₁
Always "0"			<input type="text"/> D ₁₀	<input type="text"/> D ₁₀
Always "0"			<input type="text"/> D ₉	<input type="text"/> D ₉
Taxable status: See page 70.			<input type="text"/> <input type="text"/> D ₈ D ₇	<input type="text"/> <input type="text"/> D ₈ D ₇
Enable 0 unit price.	a	No = 0 Yes = 1	<input type="text"/> (a+b+c) D ₆	<input type="text"/> (a+b+c) D ₆
Enable negative price.	b	No = 0 Yes = 2		
Hash	c	No = 0 Yes = 4		
Always "0"			<input type="text"/> D ₅	<input type="text"/> D ₅
Low digit limitation (LDL) for manually entered unit price.		Significant number	<input type="text"/> D ₄	<input type="text"/> D ₄
Open PLU (only for PLU)		No = 0 Yes = 4	<input type="text"/> D ₃	<input type="text"/> D ₃
Commission 1	a	No = 0 Yes = 1	<input type="text"/> (a+b) D ₂	<input type="text"/> (a+b) D ₂
Commission 2	b	No = 0 Yes = 2		
Always "0"			<input type="text"/> D ₁	<input type="text"/> D ₁

Department key/PLU program (Individual feature programming)

Programming procedure

Department key

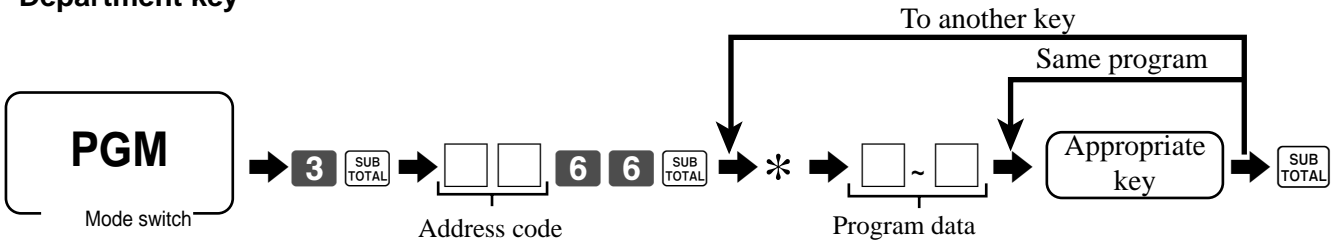

*: In case of shifting department, press <DEPT SHIFT> key first.

PLU

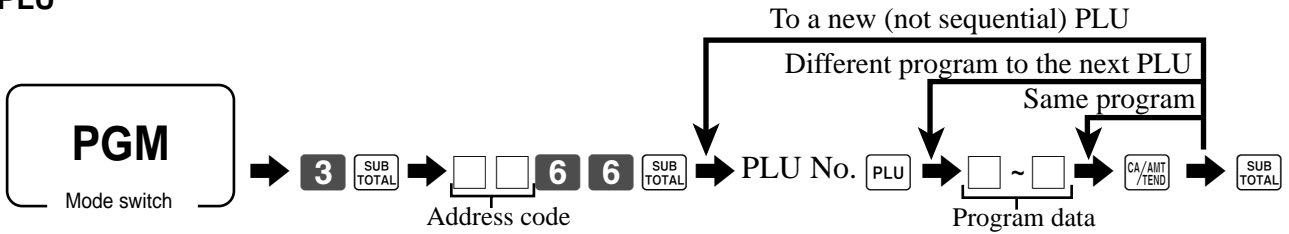

Advanced Operations and Setups

Program data (by address code)

Address code 11 (link)

Description	Choice	Program code
Link group record number: (000 ~ 999)	Significant numbers	<input type="text"/> <input type="text"/> <input type="text"/> D ₇ D ₆ D ₅
Always "0"		<input type="text"/> D ₄
Link department record number: (000 ~ 999) (only for PLU)	Significant numbers	<input type="text"/> <input type="text"/> <input type="text"/> D ₃ D ₂ D ₁

Address code 15 (high amount limit)

Description	Choice	Program code
High amount limit for entering unit price manually.	Significant numbers	<input type="text"/> <input type="text"/> <input type="text"/> <input type="text"/> <input type="text"/> <input type="text"/> D ₆ D ₅ D ₄ D ₃ D ₂ D ₁

Other address code

Address code	Description	Choice	Program code
18	Single item control: Normal receipt = 0, Single item receipt = 3	Significant number	<input type="text"/>
03	Taxable status: See page 70.	Significant numbers	<input type="text"/> <input type="text"/> D ₂ D ₁
05	Enable 0 unit price.	a	No = 0 Yes = 1
	Enable negative price.	b	No = 0 Yes = 2
	Hash	c	No = 0 Yes = 4
07	Low digit limitation (LDL) for manually entered unit price.	Significant number	<input type="text"/>
04	Open PLU (Only for PLU)	No = 0 Yes = 4	<input type="text"/>
09	Commission 1	a	No = 0 Yes = 1
	Commission 2	b	No = 0 Yes = 2

Taxable status

for Singapore

Always "0"			<input type="text"/> D ₈
Taxable 1 status	a	No = 0 Yes = 1	<input type="text"/> (a+b+c) D ₇
Taxable 2 status	b	No = 0 Yes = 2	
Taxable 3 status	c	No = 0 Yes = 4	

for Other area

Non tax = 00 Taxable 3 = 03	Taxable 1 = 01 Taxable 4 = 04	Taxable 2 = 02 All taxable 99 *	Significant numbers	<input type="text"/> <input type="text"/> D ₈ D ₇
--------------------------------	----------------------------------	------------------------------------	---------------------	--

* Only for function keys

Transaction key program

Programming procedure

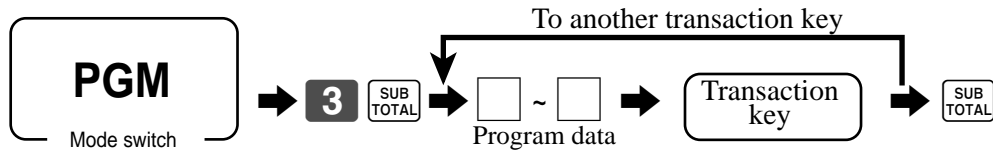

Program data

<CASH>, <CHARGE>, <CHECK>

Description		Choice	Program code
Restriction (to 00, 25, 50, 75) on last two digits for amount tendered (Only for <CASH> in Danish rounding)		No = 0 Yes = 4	<input type="checkbox"/> D ₁₀
Always "00"			<input type="text" value="0"/> <input type="text" value="0"/> D ₉ D ₈
Prohibit entry of a partial payment	a	No = 0 Yes = 1	<input type="checkbox"/> (a+b+c) D ₇
Prohibit the entry of the amount tendered.	b	No = 0 Yes = 2	
Force entry of the amount tendered.	c	No = 0 Yes = 4	
Print VAT breakdown. *1		No = 0 Yes = 1	<input type="checkbox"/> D ₆
French food coupon	a	No = 0 Yes = 1	<input type="checkbox"/> (a+b) D ₅
Perform Finnish rounding.	b	No = 0 Yes = 4	
High amount limit specification for subtotal and tendering amounts.		Maximum value (0 ~ 9)	<input type="text"/> <input type="text"/> D ₄ D ₃
		Number of zeros (0 ~ 9)	
High amount limit specification for change amount due.		Maximum value (0 ~ 9)	<input type="text"/> <input type="text"/> D ₂ D ₁
		Number of zeros (0 ~ 9)	

*1 This is valid option for Single item or Currency exchange (include partial tender) as well.

<RECEIVED ON ACCOUNT>, <PAID OUT>

Description	Choice	Program code
High amount limit specification for entering amounts	Maximum value (0 ~ 9)	<input type="text"/> <input type="text"/> D ₄ D ₃
	Number of zeros (0 ~ 9)	
Always "00"		<input type="text" value="0"/> <input type="text" value="0"/> D ₂ D ₁

Advanced Operations and Setups

<REDUCTION (MINUS)>, <COUPON>

Description		Choice	Program code
Taxable status: See page 70.			<input type="checkbox"/> <input type="checkbox"/> D ₈ D ₇
Allow credit balance. (-, CPN only)		No = 0 Yes = 1	<input type="checkbox"/> D ₆
Always "00"		No = 0 Yes = 2	<input type="checkbox"/> <input type="checkbox"/> D ₅ D ₄
High digit limitation (HDL) for manually entered unit price ("9" means NOT allow manual entry.)			<input type="checkbox"/> D ₃
Commission 1	a	Significant number	<input type="checkbox"/> (a+b) D ₂
Commission 2	b	No = 0 Yes = 1	
Always "0"		No = 0 Yes = 2	<input type="checkbox"/> D ₁

<PREMIUM (%+)>, <DISCOUNT (%-)>

Description		Choice	Program code
Taxable status: See page 70.			<input type="checkbox"/> <input type="checkbox"/> D ₈ D ₇
Prohibit manual rate override.		No = 0 Yes = 2	<input type="checkbox"/> D ₆
Rounding: Round off = 0, cut off = 1, round up = 2		Significant number	<input type="checkbox"/> D ₅
Always "00"			<input type="checkbox"/> <input type="checkbox"/> D ₄ D ₃
Commission 1	a	No = 0 Yes = 1	<input type="checkbox"/> (a+b) D ₂
Commission 2	b	No = 0 Yes = 2	
Always "0"			<input type="checkbox"/> D ₁

<NON-ADD (#)>

Description	Choice	Program code
Allow mode change or clerk change after non-add registration as first transaction. (only for non-add function)	Yes = 0 No = 1	<input type="checkbox"/> D ₇
Always "0000"		<input type="checkbox"/> <input type="checkbox"/> <input type="checkbox"/> <input type="checkbox"/> D ₆ D ₅ D ₄ D ₃
Always "00"		<input type="checkbox"/> <input type="checkbox"/> D ₂ D ₁

<SUBTOTAL>

Description	Choice	Program code
Print when key is pressed.	No = 0 Yes = 4	<input type="checkbox"/> D ₆
Always "00000"		<input type="checkbox"/> <input type="checkbox"/> <input type="checkbox"/> <input type="checkbox"/> <input type="checkbox"/> D ₅ D ₄ D ₃ D ₂ D ₁

<CURRENCY EXCHANGE>

Description		Choice	Program code
Define amount symbol. (0, 1 ~ 2) ("0" means local currency symbol.)		Significant number	<input type="checkbox"/> D ₇
Define foreign currency totalizer. (0, 1 ~ 2) ("0" treats as "1".)		Significant number	<input type="checkbox"/> D ₆
Rounding: Round off = 0, cut off = 1, round up = 2		Significant number	<input type="checkbox"/> D ₅
Always "0"			<input type="checkbox"/> D ₄
Monetary mode (0 ~ 9): □□□ = 2, □□ = 1, □ = 0, □□□□ = 3		Significant number	<input type="checkbox"/> D ₃
Monetary symbol for decimal	a	Decimal = 0 Comma = 1	<input type="checkbox"/> (a+b) D ₂
Monetary symbol for separator	b	Comma = 0 Decimal = 4	
Always "0"			<input type="checkbox"/> D ₁

<MULTIPLICATION>

Description		Choice	Program code
Multiplication procedure: (<X> only) ① Quantity × Amount, ② Amount × Quantity		① = 0 ② = 1	<input type="checkbox"/> D ₆
Rounding: Round off = 0, cut off = 1, round up = 2		Significant number	<input type="checkbox"/> D ₅
Always "0000"			<input type="checkbox"/> <input type="checkbox"/> <input type="checkbox"/> <input type="checkbox"/> D ₄ D ₃ D ₂ D ₁

Advanced Operations and Setups

Clerk program

Clerk number, check number programming

Programming procedure

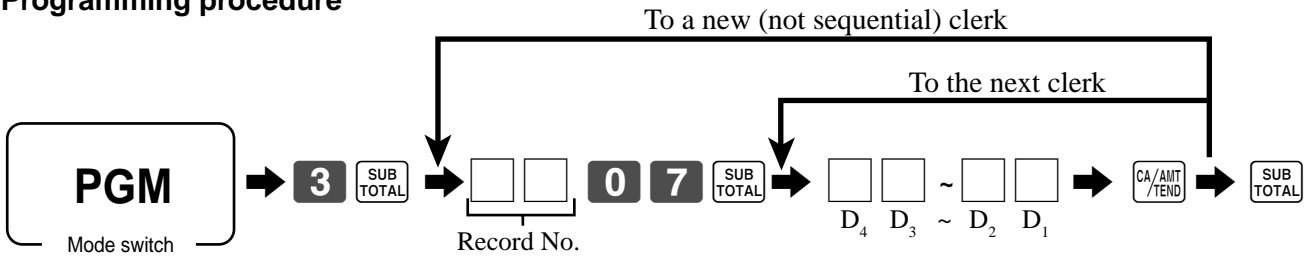

Program Data

Description	Choice	Program code
Clerk secret number	Significant numbers	<input type="text"/> <input type="text"/> <input type="text"/> <input type="text"/> D ₄ D ₃ D ₂ D ₁

Clerk other programming

Programming procedure (individual)

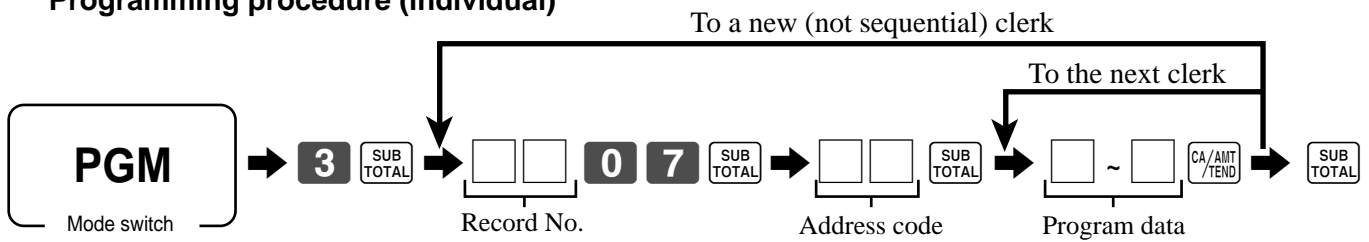

Program data

Address code 67 (Clerk control)

Description	Choice	Program code
Training clerk	No = 0 Yes = 1	<input type="text"/> D ₆
Always "00000"		<input type="text"/> <input type="text"/> <input type="text"/> <input type="text"/> <input type="text"/> D ₅ ~D ₁

Address code 68 (Commission rate)

Description	Choice	Program code
Commission rate 1 (integer: 00 ~ 99)	Significant numbers	<input type="text"/> <input type="text"/> D ₈ D ₇
Commission rate 1 (decimal: 00 ~ 99)	Significant numbers	<input type="text"/> <input type="text"/> <input type="text"/> D ₆ D ₅
Commission rate 2 (integer: 00 ~ 99)	Significant numbers	<input type="text"/> <input type="text"/> <input type="text"/> D ₄ D ₃
Commission rate 2 (decimal: 00 ~ 99)	Significant numbers	<input type="text"/> <input type="text"/> <input type="text"/> D ₂ D ₁

Printing read/reset reports

- **Daily sales read report (“X” mode)**

You can print read reports at any time during the business day without affecting the data stored in the cash register's memory.

- **Daily sales reset report (“Z” mode)**

You should print reset reports at the end of the business day.

Important!

- The reset operation issues a report and also clears all sales data from the cash register's memory.
- Be sure to perform the reset operations at the end of each business day. Otherwise, you will not be able to distinguish between the sales data for different dates.

To print the individual department, PLU read report

This report shows sales for specific departments or PLUs.

OPERATION	DISPLAY
-----------	---------

1. Turn to X mode.

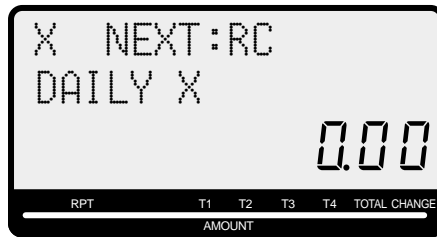
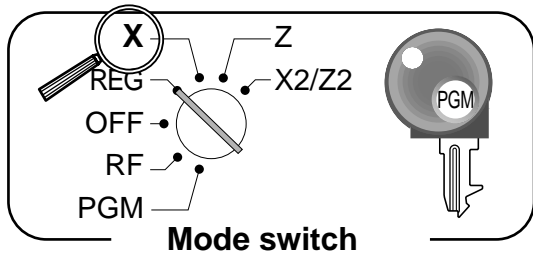

2. Specify a department / PLU

- Specifying a department
, , ...
- Specifying a PLU
 , ...

3. Press <ST> to exit this report.

REPORT

X	INDIVIDUAL	Read symbol/report title
DEPT001	38	Department Name/No. of items
8.13%	.257.53	Sales ratio/amount
PLU0001	17	PLU Name/No. of items
0.53%	.17.00	Sales ratio/PLU amount
#0001		PLU code

TL	88.61	Total No. of items
	.516.10	Total amount

To print daily read reports (except electronic journal)

You can select the appropriate report shown in the display.

OPERATION

1. Turn to X mode.

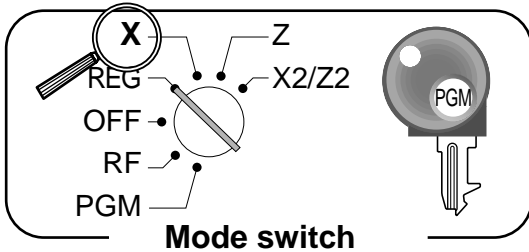

DISPLAY

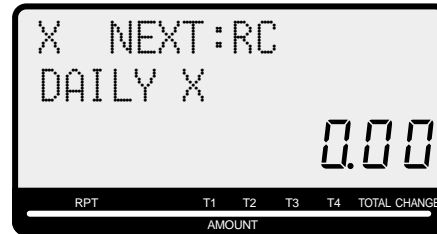

2. Select report you want to get by the <RC> key.



3. Press <CASH> to print report. *1

*1 If money declaration is necessary, count how much cash is in the drawer and input this amount (up to 10 digits) and press <#> key.

The cash register will automatically compare the input with the cash in drawer in the memory and print the difference between these two amounts.

Note that if money declaration is required by programming, you cannot skip this procedure.

To print electronic journal read report

OPERATION

1. Turn to X mode.
2. Select electronic journal report by the <RC> key.
3. Press <CASH> key, enter start date and/or consecutive no. and press <CASH> key.

Advanced Operations and Setups

To print daily reset reports

You can select the appropriate report shown in the display.

OPERATION

DISPLAY

1. Turn to Z mode.

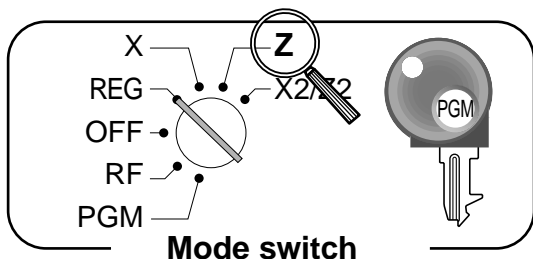

2. Select report you want to get by the <RC> key.



3. Press <CASH> to print report. *1

*1 If money declaration is necessary, count how much cash is in the drawer and input this amount (up to 10 digits) and press <#> key.

The cash register will automatically compare the input with the cash in drawer in the memory and print the difference between these two amounts.

Note that if money declaration is required by programming, you cannot skip this procedure.

Read / reset report sample

Daily report

<pre> ----- Z DAILY ----- Z DEPT 0001 0001015 DEPT001 38 8.13% 257.53 DEPT001 183 1,362.26 ----- TL 88.61 1,916.10 ----- Z FIX 0001 0001011 DECLA 6,919.04 0.00 GROSS 981.25 6,574.40 NET No 111 7,057.14 CAID 6,919.04 CHID 139.04 CKID 859.85 CRID(1) 709.85 CRID(2) 0.00 CRID(3) 0.00 CRID(4) 0.00 ----- RF No 3 10.22 CUST CT 111 AVRG 63.57 </pre>	<p>Report title</p> <p>Department report title/reset counter</p> <p>Report code</p> <p>Department name/No. of items *2</p> <p>Sales ratio/amount *2</p> <p>Total No. of items</p> <p>Total amount</p> <p>Fixed total report title/reset counter *4</p> <p>Report code</p> <p>Declared cash in drawer of main currency *1</p> <p>Difference (= declared - accumulated) *1</p> <p>Gross total *3</p> <p>Net total *3</p> <p>Cash in drawer *3</p> <p>Charge in drawer *3</p> <p>Check in drawer *3</p> <p>Credit in drawer 1 *3</p> <p>Credit in drawer 1 *3</p> <p>Credit in drawer 1 *3</p> <p>Credit in drawer 1 *3</p> <p>Refund mode *3</p> <p>Customer number *3</p> <p>Average sales per customer *3</p>
<pre> DC 1.22 REF 2.42 ROUND 0.00 CANCEL No 2 12.97 ----- TA1 2,369.69 TX1 128.86 TA2 2,172.96 TX2 217.33 ----- GT 00000000125478.96 ----- Z TRANS 0001 0001012 CASH No 362 1,638.04 CHARGE No 56 1,174.85 RC No 4 810.00 PD No 5 520.00 5.00 CORR No 14 39.55 PCT No 3 NS 5 ----- Z CASHIER 0001 0001017 C01 1 NET No 111 1,845.35 C02 1 </pre>	<p>Discount total *3</p> <p>Refund key *3</p> <p>Rounding total *3</p> <p>Cancellation *3</p> <p>Taxable 1 amount *3</p> <p>Tax 1 amount *3</p> <p>Taxable 2 amount *3</p> <p>Tax 2 amount *3</p> <p>Grand total *3</p> <p>Function key report title/reset counter</p> <p>Report code</p> <p>Function key count/amount *2</p> <p>Clerk report title/reset counter</p> <p>Report code</p> <p>Clerk name</p> <p>Net total</p> <p>Clerk name/drawer No.</p>

*1 Zero totalled departments/functions (the amount and item numbers are both zero) are not printed.

*2 These items can be skipped by programming.

Advanced Operations and Setups

Flash report

X	FLASH		0000071	Read symbol/report title
				Report code
DECLA		-6,919.04		Main currency declared amount
		.00		Difference
GROSS		111.15		Gross total
		-7,054.14		
NET	No	120		Net total
		-7,263.20		
CAID		-6,919.04		Cash in drawer

PLU report

X	PLU		0000014	Read symbol/report title
				Report code
PLU0001		17		PLU name/No. of items
0.53%		-17.00		Sales ratio/PLU amount
#0001				PLU code
PLU0100		42		
		-69.00		

#0100				
TL		188.61		Total No. of items
		-516.10		Total amount

Hourly report

X	HOURLY		0000019	Read symbol/report title
				Report code
00:00->01:00				Time range
	CT	1		No. of customers
GROSS		-1.10		Gross sales amount
NET	No	1		No. of receipt
1.90%		-1.20		Sales ratio/net sales amount

23:00->00:00				
	CT	1		
GROSS		-3.45		
NET	No	1		
3.90%		-3.59		

TL	CT	280		Total No. of customers
GROSS		-1,937.61		Gross total amount
NET	No	25		Total No. of receipt
		-2,096.80		Net total amount

Monthly report

X	MONTHLY		0000020	Read symbol/report title
				Report code
1.....				Date of a month
GROSS		1236.76		Gross symbol/No. of items
		-12,202.57		Gross sales amount
NET	No	214		Net symbol/No. of customers
		-12,202.57		Net sales amount

31.....				
GROSS		2132		
		-14,187.57		
NET	No	205		
		-13,398.76		

TL				Total symbol
GROSS		9746.63		Gross symbol/No. of items
		-161,022.49		Gross sales amount
		-16.52		Average daily gross sales
NET	No	2351		Net symbol/No. of customers
		-161,022.49		Net sales amount
		-68.49		Average daily net sales

Group report

X	GROUP		0000016	Read symbol/report title Report code
	GROUP01	203.25		Group No./No. of items
	33.87%	· 1,108.54		Sales ratio/group amount
	GROUP02	183		
	40.58%	· 1,327.80		
	GROUP03	12		
		· 13.25		
	GROUP99	12		
	0.54%	· 17.80		

	TL	862		Group total No. of items
		· 3,272.00		Group total amount

Electronic journal report

X	E-JOURNAL		0000058	Report header/title Report code
	REG 03-06-2008 11:58			
	C01 0001 000123			
	1 DEPT01 T1	-1.00		
	1 DEPT02 T1	-2.00		
	5 DEPT03	-5.00		Journal image
		7 No		
	TA1	· 3.00		
	TX1	-0.15		
	TX1	-0.10		
	TL	- 8.10		
	CASH	· 10.00		
	CG	- 1.90		
	REG 03-06-2008 11:59			
	C01 0001 000124			

Advanced Operations and Setups

• Periodic sales read report (“X2” mode)

You can print read reports at any time during the business day without affecting the data stored in the cash register's memory.

• Periodic sales reset report (“Z2” mode)

You should print reset reports at the end of the business day.

To print the periodic 1/2 sales read/reset reports

These reports show sales breakdowns of sales by any two kinds of period you want.

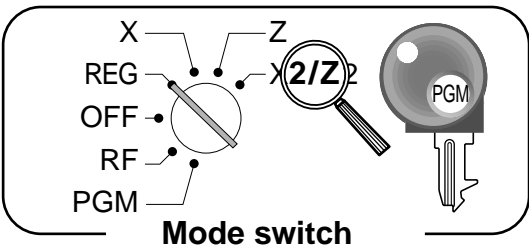
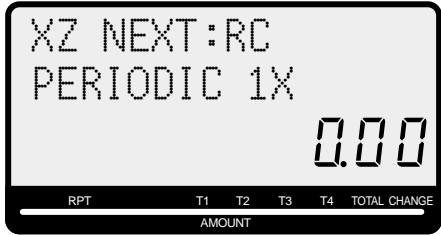
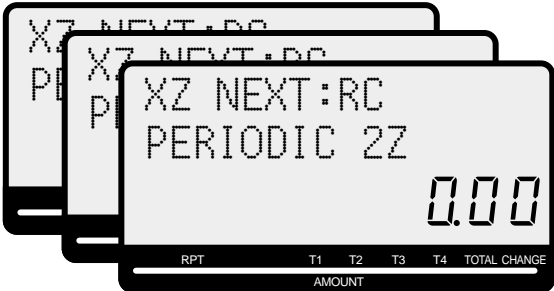
OPERATION	DISPLAY
<p>1. Turn to X2/Z2 mode.</p>  <p>Mode switch</p>	
<p>2. Select report you want to get by the <RC> key.</p>	
<p>3. Press <CASH> to print report.</p>	

ZZ1 PERIODIC 1Z		Report title

ZZ1 DEPT	0001	Department report title/reset counter
	0001115	Report code

DEPT001	38	Department Name/No. of items *1
8.13%	.257.53	Sales ratio/amount *1
DEPT000	18	

	.1,362.26	

TL	88.61	Total No. of items
	.1,916.10	Total amount

ZZ1 FIX	0001	Fixed total report title/reset counter
	0001111	Report code

GROSS	981.25	Gross total *2
	.6,574.40	
NET	No 111	Net total *2
	.7,057.14	
CAID	.6,919.04	Cash in drawer *2
CHID	.139.04	Charge in drawer *2
CKID	.859.85	Check in drawer *2
CRID(1)	.709.85	Credit in drawer 1 *2
CRID(2)	.0.00	Credit in drawer 2 *2
CRID(3)	.0.00	Credit in drawer 3 *2
CRID(4)	.0.00	Credit in drawer 4 *2

RF	No 3	Refund mode *2
	.10.22	
CUST	CT 111	Customer number *2
AVRG	.63.57	Average sales per customer *2
DC	.1.22	Discount total *2
REF	.2.42	Refund key *2
ROUND	.0.00	Rounding total *2
CANCEL	No 2	Cancellation *2
	.12.97	

TA1	.2,369.69	Taxable 1 amount *2
TX1	.128.86	Tax 1 amount *2
TA2	.2,172.96	Taxable 2 amount *2
TX2	.217.33	Tax 2 amount *2

ZZ1 TRANS	0001	Function key report title/reset counter
	0001112	Report code

CASH	No 362	Function key count/amount *1
	.1,638.04	
CHARGE	No 56	
	.1,174.85	
RC	No 4	
	.810.00	
PD	No 5	
	.5.00	
CORR	No 14	
	.39.55	
BCT	No 3	
	.5	
NS		

ZZ1 CASHIER	0001	Clerk report title/reset counter
	0001117	Report code

C01 1	Clerk name
NET	No 111	Net total
	.1,845.35	

C02 1	Clerk name

*1 Zero totalled departments/functions (the amount and item numbers are both zero) are not printed.

*2 These items can be skipped by programming.

Reading the cash register's program

To print unit price/rate program (except PLU)

OPERATION	REPORT
<ol style="list-style-type: none"> 1. Turn to PGM mode. 2. Enter <1> and press <ST> key. 3. Press <ST> key. 	<p> P01..... Program read symbol CASH @0.00 - @1.00 Transaction key unit price or rate % 10% DEPT001 0001-05 Department descriptor/rec-#/05 @1.00 Unit price DEPT002 0002-05 @1.00 </p>

To print key descriptor, name, message program (except PLU)

OPERATION	REPORT
<ol style="list-style-type: none"> 1. Turn to PGM mode. 2. Enter <2> and press <ST> key. 3. Press <ST> key. 	<p> P02..... Program read symbol GROSS 0001-01 NET 0002-01 Fix total character CAID 0003-01 0004-01 CASH 0001-02 Transaction key character CHECK 0002-02 0003-02 0004-02 DEPT001 0001-05 Department character DEPT002 0002-05 0003-05 0004-05 GROUP01 0001-06 Group character GROUP02 0002-06 0003-06 0004-06 C01 0001-07 Clerk character C02 0002-07 0003-07 GT 0001-20 GT character @No/ ** € 0001-23 NoCT @LB *QT 0002-23 X BUSY 0003-23 Special character </p> <p> FIX 0001-24 Report header character TRANS 0002-24 0003-24 0004-24 DAILY X 0001-29 Batch X/Z character PERIODIC 1X 0002-29 PERIODIC 2X 0003-29 0004-29 0001-32 YOUR RECEIPT Receipt message 0002-32 THANK YOU 0001-39 Text recall character CHARACTER RECALL***** ***** 0002-39 ***** MC#01 0001-91 0001-97 </p>

Advanced Operations and Setups

To print the PLU unit price

OPERATION

1. Turn to PGM mode.
2. Enter <6> and press <ST> key.
3. Enter <104> and press <ST> key.
4. Enter <start rec-#> and <CA> key.
5. Enter <end rec-#> and <CA> key.

REPORT

P01.....		Program read symbol
#0001 - #0010		PLU range
PLU0001	0001-04	PLU descriptor/rec-#/04
	@1.00	Unit price
PLU0002	0002-04	
	@2.00	

To print the PLU descriptor

OPERATION

1. Turn to PGM mode.
2. Enter <6> and press <ST> key.
3. Enter <204> and press <ST> key.
4. Enter <start rec-#> and <CA> key.
5. Enter <end rec-#> and <CA> key.

REPORT

P02.....		Program 2 mode symbol
#0001 - #0010		PLU range
PLU0001	0001-04	PLU character
PLU0002	0002-04	
PLU0003	0003-04	

To print the PLU program

OPERATION

1. Turn to PGM mode.
2. Enter <6> and press <ST> key.
3. Enter <304> and press <ST> key.
4. Enter <start rec-#> and <CA> key.
5. Enter <end rec-#> and <CA> key.

REPORT

P03.....		Program 3 mode symbol
#0001 - #0010		PLU range
PLU0001	0001-04	PLU descriptor/rec-#/file-#
	00000000000000	Address code 01 ~ 10, 18 program
11-66	000000	Address code 11 program
13-66	<- 0001-28	Address code 13 program
14-66	0	
15-66	@1234.56	Address code 15 program
PLU0002	0002-04	

Troubleshooting

This section describes what to do when you have problems with operation.

When an error occurs

Errors are indicated by an error codes. When this happens, you can usually find out what the problem is as illustrated below.

Press **C** and check the appropriate section of this manual for the operation you want to perform.

Error code	Message	Meaning	Action
E001	Wrong mode	Mode switch position changed before finalization.	Return the mode switch to its original setting and finalize the operation.
E003	Wrong operator	The signed on clerk differs from the clerk performed the tracking check registration.	Input correct check number or assign the proper clerk number.
E004	Error INIT/FC	Initialization or unit lock clear operation in progress.	Complete operation.
E008	Please sign on	Registration without entering a clerk number.	Enter a clerk number.
E010	Close the drawer	The drawer is left open longer than the program time (drawer open alarm).	Close the drawer.
E011	Close the drawer	Attempt to register while the cash drawer is open.	Shut the cash drawer.
E016	Change back to REG mode	Two consecutive transactions attempted in the refund mode.	Switch to another mode and then back to the RF mode for the next transaction.
E017	Enter CHK/TBL number	Attempt made to register an item without inputting a check number.	Input a check number.
E018	Enter Table number	Attempt made to register an item without inputting a table number.	Input a table number.
E019	Enter number of customers	Finalize operation attempted without entering the number of customer.	Enter the number of customer.
E021	No DEPT Link	No department linked PLU is registered.	Correct the program.
E026	Enter condiment/preparation PLU	No condiment/preparation PLU is registered.	Register condiment/preparation PLU.
E029	In the tender operation	Item registration is prohibited, while partial tender.	Finalize the transaction.
E031	Press ST key	Finalization of a transaction attempted without confirming the subtotal.	Press <SUBTOTAL>.
E033	Enter tendered amount	Finalize operation attempted without entering amount tender.	Enter the amount tendered.
E035	Change amount exceeds limit	Change amount exceeds preset limit.	Input amount tendered again.
E036	Remove money from the drawer	Contents of the drawer exceed programmed limit.	Perform payout operation.
E037	Digit or amount limitation over	High amount lock out/low digit lock out error	Enter correct amount.
E038	Perform money declaration	Read/reset operation without declaring cash in drawer. This error appears only when this function is activated.	Perform money declaration.
E040	Issue guest receipt	Attempt to register a new transaction without issuing a guest receipt.	Issue a guest receipt.
E046	REG buffer full	Registration buffer full.	Finalize the transaction.
E049	CHECK memory full	Check tracking index memory full.	Finalize and close the check number currently used.
E050	DETAIL memory full	Check tracking detail memory full.	Finalize and close the check number currently used.
E051	CHK/TBL No. is occupied	Attempt to made use <New Check> to open a new check using a number that is already used for an existing check in check tracking memory.	Finalize and close the check that is currently under the number that you want to use or use a different check number.
E053	CHK/TBL No. is not opened	Attempt made to use <Old Check> reopen a new check using a number that is not used for an existing check in check tracking memory.	Use the correct check number (if you want to reopen a check that already exists in check tracking memory) or use <New Check> to open a new check.
E075	Negative balance cannot be finalized	Attempt to finalize a transaction when balance is less than or equal to zero.	Register item(s) until the balance becomes positive amount.

Error code	Message	Meaning	Action
E101	PLU maintenance file full. Press <#2> to exit	Scanning PLU direct maintenance/batch maintenance file becomes full.	Terminate the maintenance.
E103	PLU Code is not exist. Input the PLU Code	PLU code is not existed in the file.	Enter proper PLU code.
E105	PLU file full	Scanning PLU file full	Modify the designated item.
E106	Item exists in the PLU FILE	The designated item has already existed in the scanning PLU file.	
E112	Close the journal platen arm	The journal platen arm is opened.	Close the journal platen arm.
E114	Close the receipt platen arm	The receipt platen arm is opened.	Close the receipt platen arm.
E139	Negative balance is not allowed	Attempt to register <-> or <CPN> when the balance becomes negative.	Enter proper minus/coupon amount.
E146	Arrangement file full	Arrangement file is full.	Set the arrangement properly.
E200	Insert RAC	RAC is set.	Set RAC.
E201	Illegal Format	Illegally formatted RAC	Format the RAC.
E202	File not found	The designated file is not found in the RAC.	Enter proper file name.
E205	File already exist.	Can not write, because designated file has already been in the RAC.	Check the operation and retry.

When the * sign appears on the display

- Electronic journal memory near-end and memory full:

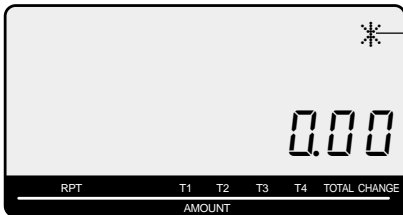

Important!

- When the register shows this sign, issue electronic journal read report (if necessary) and reset this memory immediately.

— Electronic journal memory near end memory full symbol

When the cash drawer does not open!

In case of power failure or the machine is in malfunction, the cash drawer does not open automatically. Even in these cases, you can open the cash drawer by pulling drawer release lever (see below).

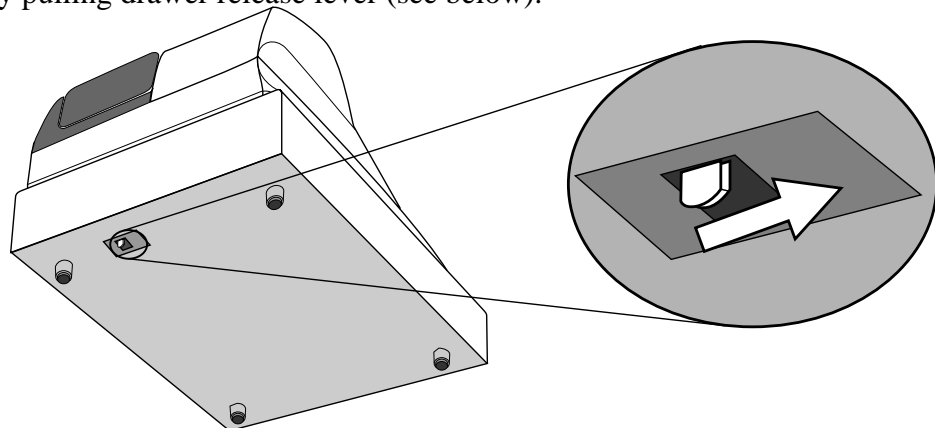

Important!

The drawer will not open, if it is locked with a drawer lock key.

When the register does not operate at all

Perform the following check whenever the cash register enter an error condition as soon as you switch it on. The results of this check are required by service personnel, so be sure to perform this check before you contact a CASIO representative for servicing.

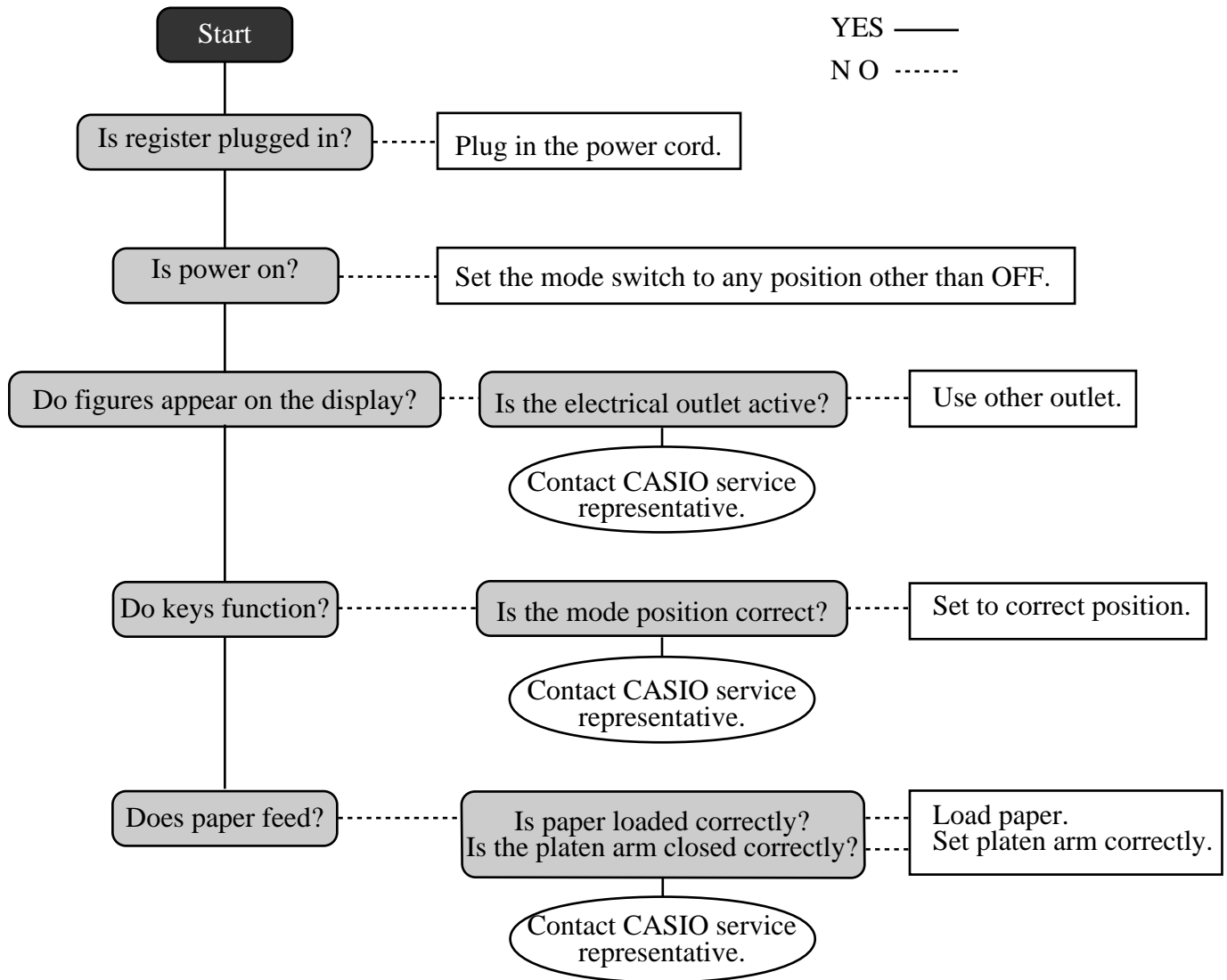

Clearing a machine lock up

If you make a mistake in operation, the cash register may lock up to avoid damage to programs and preset data. Should it happens, you can use the following procedure to clear the lock up without losing any data.

- 1 Power off the register.
- 2 Insert the PGM key in the mode switch.
- 3 Press down **FEED**, and turn the mode switch to PGM mode.
- 4 The display shows 0.00, then release **FEED**.
- 5 Press **SUB/TOTAL**, then issue a receipt.

In case of power failure

If the power supply to the cash register is cut by a power failure or any other reason, simply wait for power to be restored. The details of any ongoing transaction as well as all sales data in memory are protected by the memory backup batteries. (This is the reason to install the batteries.)

- Power failure during a registration
The subtotal for items registered up to the power failure is retained in memory. You will be able to continue with the registration when power is restored.
- Power failure during printing a read / reset report
The data already printed before the power failure is retained in memory. You will be able to issue a report when power is restored.
- Power failure during printing of a receipt / journal
Printing will resume after power is restored. A line that was being printed when the power failure occurred is printed in full.
- Other
The power failure symbol is printed and any item that was being printed when the power failure occurred is reprinted in full.

Important!

Once receipt / journal printing or printing of a report starts, it can be stopped only by interruption of power to the cash register.

When the L sign appears on the display

About the low battery indicator...

The following shows the low battery indicator.

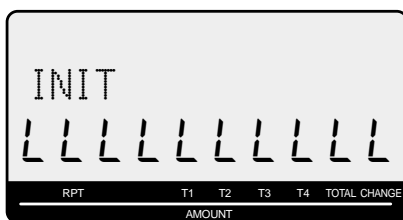

If this indicator appears when you switch the cash register on, it can mean one of three things:

- No memory backup batteries are loaded in the cash register.
- The power of the batteries loaded in the unit is below a certain level.
- The batteries loaded in the unit are dead.

Important!

Whenever the low battery indicator appears on the display, load a set of two new batteries as soon as possible. If there is a power failure or you unplug the cash register when this indicator appears, you will lose all of your sales data and settings.

**BE SURE TO KEEP THE POWER CORD OF THE CASH REGISTER
PLUGGED IN WHENEVER YOU REPLACE THE BATTERIES.**

To replace journal paper



Step 1

Set the mode switch to the REG position and remove the printer cover.

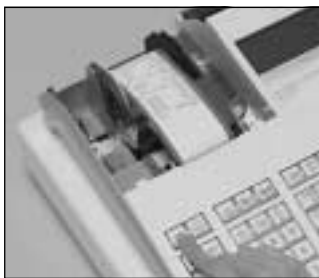
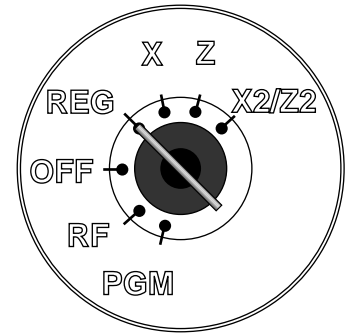

Step 2

Press **FEED** to feed about 20 cm of paper.



Step 6

Slide the printed journal from the take-up reel.



Step 3

Cut the journal paper at the point where nothing is printed.



Step 7

Open the platen arm.



Step 4

Remove the journal take-up reel from its holder.



Step 8

Remove the old paper roll from the cash register.



Step 5

Remove the paper guide from the take-up reel.

Step 9

Load new paper.

Go to the step 3 described on page 12 of this manual.

To replace receipt paper



Step 1

Set the mode switch to the REG position and remove the printer cover.



Step 2

Open the platen arm.



Step 3

Remove the old paper roll from the cash register.

Step 4

Load new paper.

Go to the step 3 described on page 11 of this manual.

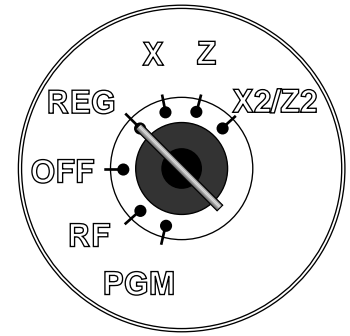

Options

P-5880T roll paper

WT-89 wetproof cover

The optional wetproof cover protects the keyboard from moisture damage.

Consult your CASIO dealer for details.

Specifications

Input method

Entry: 10-key system, buffer memory 8 keys (2-key roll over)
 Department: Full key system

Display

Main: Amount 10 digits (zero suppression); No. of repeats, total, change, transaction indicator
 Descriptor 16 digits × 2 lines; item descriptor, No. of items, mode, clerk name
 Customer: Amount 8 digits (zero suppression)

Printer

Receipt / Journal: Thermal alpha-numeric system 24 digits
 Receipt: Store name or slogan is printed automatically / with receipt on/off key
 Journal: Automatic take up roll winding
 Paper roll: 58 (W) × 80 (D) mm
 Paper thickness: 0.06 ~ 0.085 mm
 Paper feed: Separate for receipt and journal
 Print speed: About 14 l/s

Listing capacity

Amount: 99999999
 Quantity: 9999,999
 Tended amount: 9999999999
 Percent: 99.99
 Tax rate: 9999.9999
 Numbers: 9999999999999999

Chronological data

Date print: Automatic date printout on receipt or journal, automatic calendar
 Time print: Automatic time printout on receipt or journal, 24-hour system/12-hour system

Alarm

Key catch tone, error alarm, sentinel alarm

Memory protection battery

The effective service life of memory protection batteries (two new size AA alkaline batteries) is approximately one year from installation into the machine.

Power supply/power consumption

See the rating plate.

Operation temperature

0°C ~ 40°C (32°F ~ 104°F)

Humidity

10 ~ 90%

Dimensions and weight

198mm (H) × 330mm (W) × 360mm (D) / 5.5kg ...with small size drawer
 (7.8" (H) × 13" (W) × 14.1" (D) / 12lbs. 2oz.)
 213mm (H) × 400mm (W) × 450mm (D) / 10kg ...with medium size drawer
 (8.4" (H) × 15.7" (W) × 17.7" (D) / 22lbs.)

Category	No. of Totalizers	Contents				Periodic Totalizer
		Amount (10 digits)	No. of items (4 digits)	Count (4 digits)	No. of customers (4 digits)	
Department	200	✓ ^{*1}	✓ ^{*3}			✓
PLU	2000	✓ ^{*1}	✓ ^{*3}			
Hourly sales	24	✓ ^{*1}			✓ ^{*4}	
Monthly	31	✓ ^{*1}			✓ ^{*4}	
Clerk	30	✓ ^{*1}			✓ ^{*4}	
Transaction key & fix total	--	✓ ^{*1}	or ✓ ^{*4}	or ✓ ^{*4}	or ✓ ^{*4}	✓
Non resettable grand sales total	1	✓ ^{*2}				
Reset counter	8			✓ ^{*4}		✓
Consecutive No.	1			✓ ^{*4}		

*1: -9,999,999.99 ~ 99,999,999.99 *2: -999,999,999.99 ~ 9,999,999,999.99 *3: -999.99 ~ 9999.99 *4: 1 ~ 9999

* Specifications and design are subject to change without notice.

A

alphabet key 53, 54
Australian GST 16

B

backlight 66
bottom message 26

C

cancel 25, 44
CAPS key 53
cash 24, 71
cash in drawer 45
change 29
character enter key 53, 54
character keyboard 53
character manual input 53
charge 25, 38, 71
check 24, 38, 71
clear 24
clear key 53, 54
clerk 46
clerk function 64
clerk name 57
clerk number 24, 46, 74
commercial message 26
commission 68, 70, 74
compressed print 66
consecutive number 26, 60
correction 42, 43
coupon 25, 50, 72
credit 38
credit balance 61
currency exchange 25, 48, 63, 73
customer display 21, 22

D

daily sales X 20
daily sales X report 76
daily sales Z 20
daily sales Z report 45, 76
daily X report 77
daily Z report 17, 78
date 28
date set 13
delete key 53, 54
department 25, 29, 56, 68, 69, 76
department number 25, 30
department report 45
department shift 25, 30
descriptor 52
descriptors by list 52
discount 24, 36, 72
display 22
double size letter key 53, 54
double Z report 63
drawer 21

drawer key 21
drawer lock 21

E

electronic journal 77
electronic journal report 81
entry restriction 64
error correct 25
euro 24, 39, 65

F

feed 24
fixed total report 45
flash report 80
function key 56
function key report 45

G

general control program 60
grand total 45, 59
gross total 45
group report 81

H

hash 68, 70
help 24
high amount limit 31, 70
high amount limitation 32
hourly report 80

I

individual key report 76
item counter 26, 61

J

journal 12, 26
journal skip 61

K

key catch tone 61
key function program 68
keyboard 21

L

link 70
local currency 39
logo message 26
low digit limitation 68, 70

M

machine feature program 60
machine number 26, 60
magnetic plate 21
main display 21, 22
memory protection 10
message 57
message control 64
mixed tender 38
mode switch 21
monthly report 80
multi tapping 54
multiplication 24, 30, 34, 73

N

negative price 68, 70
net total 45
no sale 25, 41
non-add 25, 72

O

OFF mode 20
open 25
open PLU 35, 68, 70
operator key 20

P

paid out 24, 41, 71
paper install 11
periodic sale X/Z 20
periodic sales X report 82
periodic sales Z report 82
PGM mode 20
platen 11
PLU 24, 33, 68, 69, 76
PLU report 80
pop-up display 21
post receipt 25
premium 25, 50, 72
preset graphic 26, 52, 66
preset message 26, 52, 66
preset price 32
preset tax status 32
price 24
print control 61, 62, 63, 64
printer 21
printer cover 21
program backup 17
program end key 53, 54
program key 20
program mode 20
program report 84

R

R/J selection 16
rate 36
receipt 11, 26

receipt control 64
receipt on/off 24
received on account 24, 41, 71
reduction 24, 37, 72
refund 24, 40
refund mode 20
REG mode 20
register mode 20
repeat 23, 29, 34
report 76
report descriptor 58
report sample 79
report title 45, 59
RF mode 20, 40
right cursor key 54
roll paper 21
rounding 60

S

shift key 53
sign off 24, 46
sign on 46
single item 29, 34, 47, 68, 70
space key 54
special character 59
special rounding 15
stand-by 20
status indicator 23
subtotal 24, 29, 72
subtotal compulsory 61

T

take-up reel 12, 21
tax program 24
tax status 31, 33, 36, 37
tax system 60
tax table 14
taxable status 70
thermal paper 11
time 28
time set 13
training clerk 74

U

unit price 29, 31, 33

V

VAT 25, 51

W

watermark 16

X

X mode 20, 76
X2/Z2 mode 20, 82

Z

Z mode 20, 76

zero skip 63

zero unit price 68, 70

CASIO®

CASIO COMPUTER CO., LTD.
6-2, Hon-machi 1-chome
Shibuya-ku, Tokyo 151-8543, Japan

MO0712-A Printed in Indonesia
Printed on recycled paper.
SE-S300*E

Free Manuals Download Website

<http://myh66.com>

<http://usermanuals.us>

<http://www.somanuals.com>

<http://www.4manuals.cc>

<http://www.manual-lib.com>

<http://www.404manual.com>

<http://www.luxmanual.com>

<http://aubethermostatmanual.com>

Golf course search by state

<http://golfingnear.com>

Email search by domain

<http://emailbydomain.com>

Auto manuals search

<http://auto.somanuals.com>

TV manuals search

<http://tv.somanuals.com>