

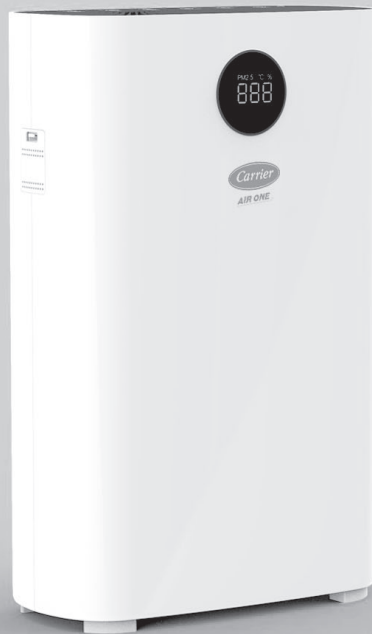

# CARRIER AIR PURIFIER

## USER MANUAL



Model No. :

Please read this manual carefully, and follow the instructions strictly.  
Please keep it properly after reading for future reference.

# CONTENTS

TYPE: CARR-AP3601T

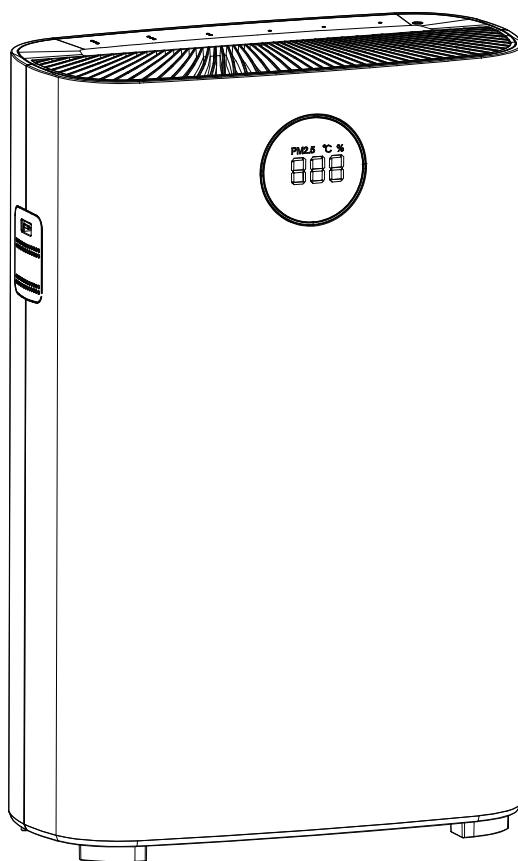



---

<b>1 Security note</b>	<b>3</b>
<hr/>	
<b>2 Product Introduction</b>	<b>5</b>
Control panel	6
Other items in the package	6
<hr/>	
<b>3 Before use</b>	<b>7</b>
Record the beginning use date in the label	7
Learning air quality indicator	7
Method of dismounting and installation	8
Placement sites of Air Purifier	8
Install filters	9
Filters and functions	11
<hr/>	
<b>4 How to use</b>	<b>13</b>
The control panel	13
Starting air purifier	13
Auto mode	14
Sleep mode	14
Wind speed adjustment	14
Timing functions	14
Anion	15
Reset	15
Air quality indicator	15
<hr/>	
<b>5 Cleaning and Maintenance</b>	<b>15</b>
Clean air purifiers	15
Clean air quality sensors	15
Clean pre-filter	16
Replace filters	18
Time for replacement of filters	20
<hr/>	
<b>6 Fault handling</b>	<b>21</b>
Warranty and service	22
To order parts or accessories	22
Accessories	22
<hr/>	
<b>7 Additional information</b>	<b>22</b>
Recycling	22
Specifications	22
<hr/>	
<b>8 Warranty description</b>	<b>23</b>
<hr/>	
<b>9 Warranty card</b>	<b>24</b>

## Security Note

In order to avoid possible damage to you or others or financial damages, please be sure to pay attention to the following safety precautions.

If the machine's power supply cord is damaged, you must entrust the manufacturers of the machine, maintenance service center or qualified technicians will change for you, in case of any danger.

## Warning



Don't touch the power plug with wet hands.

**No wet hands!**

Otherwise it may cause electric shock.



Before cleaning appliances, please make sure have power off.

**Pull the plug!**

Otherwise air purifier may run suddenly, cause accident getting an electric shock.



It is prohibited to use beyond power or connected devices specified value. Only 187-253V DC power allowed.

**Banned!**

Using universal socket or exceed the specified value of the equipment may cause overheating and fire accident.



Before start the air purifier, please insert the plug completely into the socket.

Failure to fully inserted into the socket may cause electric shock and overheating or fire accident.

- Do not use damaged plug or loose power socket.



No damage on the power line and socket.

**Banned!**

In the use of the machine, don't bind wires. Use the broken wire may cause electric shock, short circuit or fire accident.

- Ban cut, modification, excessive distortion, torsion, pull wire, or put weight on wires or plugs.



Please clean power plug regularly.

Accumulation of dust on the power plug and the moisture can damage the insulation of the plug part, resulting in fire accident.

- Pull out the power plug, then wipe with dry cloth (ban using wet cloth!).
- Remember to pull the power plug if not use for a long time.



Prohibit unauthorized apart or modified the air purifier.

**Banned take apart**

Otherwise it may cause electric shock, failure or fire accident.



Ban rod or other metals placed in the outlet or inlets.

**Banned!**

Otherwise it may affect the internal parts and cause electric shock or damage.

 Attention

**Any situation as below, please turn off the power of the machine.**

A switch does not work.

A circuit breaker or fuse burned.

The power cord or plug abnormal fever.

Finding the burning odor or abnormal sound or vibration.

Any other anomalies or failure.

Attention



Prohibited use solvent such as benzene or thinner to clean air purifier, avoid touching with insecticide spraying.

Banned!

Otherwise air purifier can rupture and cause damage, even short circuit, so that cause electric shock or fire accident.



Pull out the power plug, should hold the plug, instead of pulling wires.

Otherwise it may cause short circuit, wire and cause fire or electric shock accident or injury.



Ban in place for being fat particles using this air purifier.

Banned!

Such as inside the kitchen, can reduce the service life of air purifier filter.

- The air purifier should not be used for ventilation or extraction equipment.



Banned in high temperature, damp or wet body sites using this air purifier, such as the bathroom.

No wet!

Air purifier may leakage caused electric shock or fire accident.



Do not put the volatile substances or combustible materials, such as tobacco or Mars to float into the machine.

Away from the fire!

Away from the fire! Otherwise it may cause fire accident.



Banned use the air purifier in indoor with fumigation type pesticides.

Banned!

Chemical residue could be accumulated inside the machine, and then release from the outlet to harm health.

- After using pesticides, please let thoroughly ventilated room, before using the air purifier.



This appliance can be used by children aged from 8 years and above and persons with reduced physical, sensory or mental capabilities or lack of experience and knowledge if they have been given supervision or instruction concerning use of the appliance in a safe way and understand the hazards involved.

Children shall not play with the appliance. Cleaning and user maintenance shall not be made by children without supervision.



Wet body is prohibited.

No wet!

Otherwise it may cause electric shock and fire accident due to short circuit.

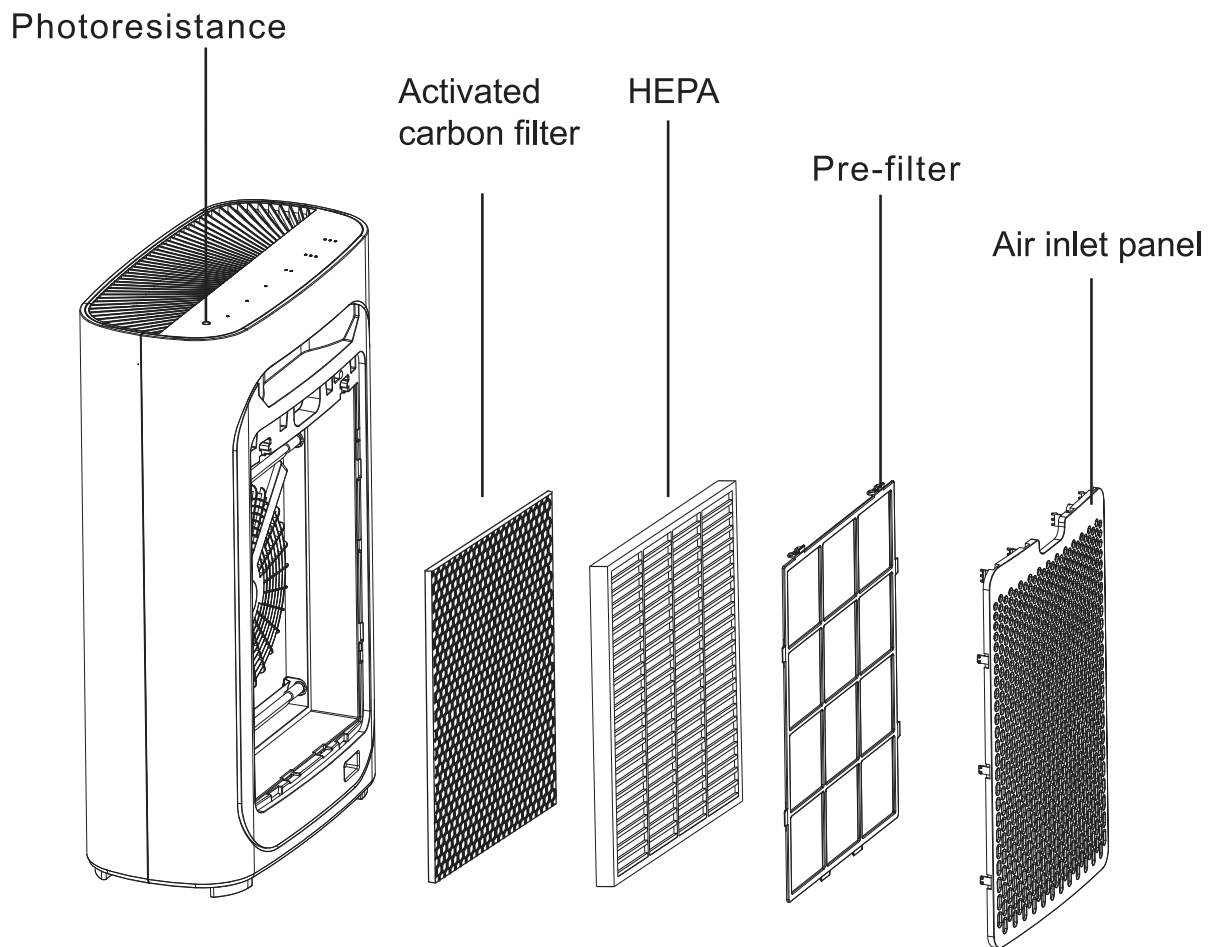
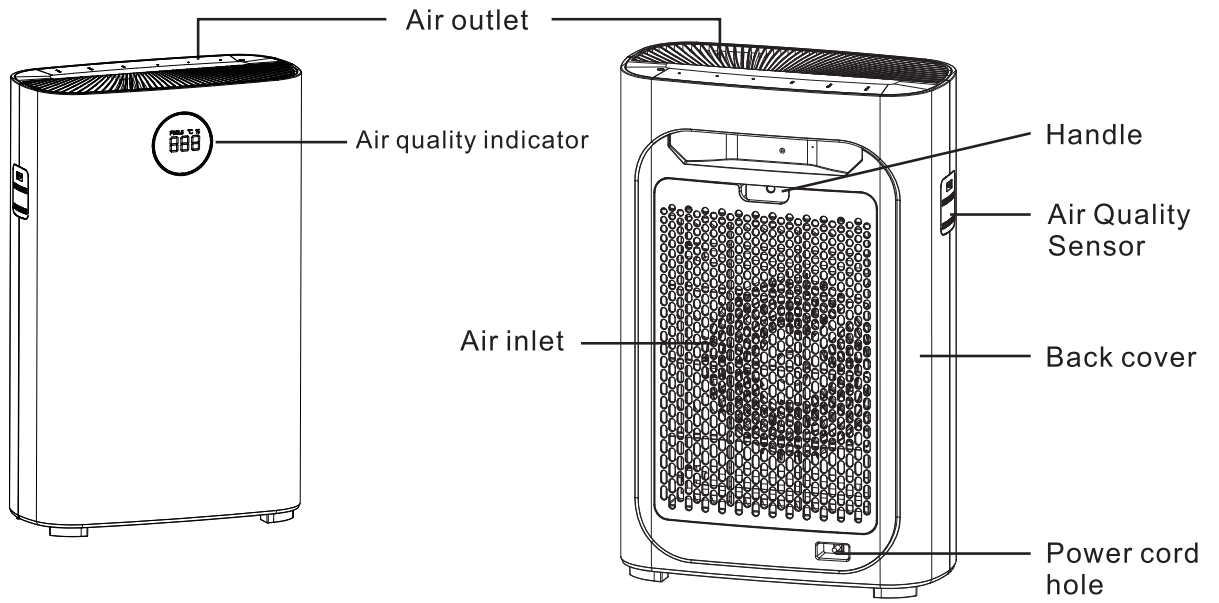

## Control panel

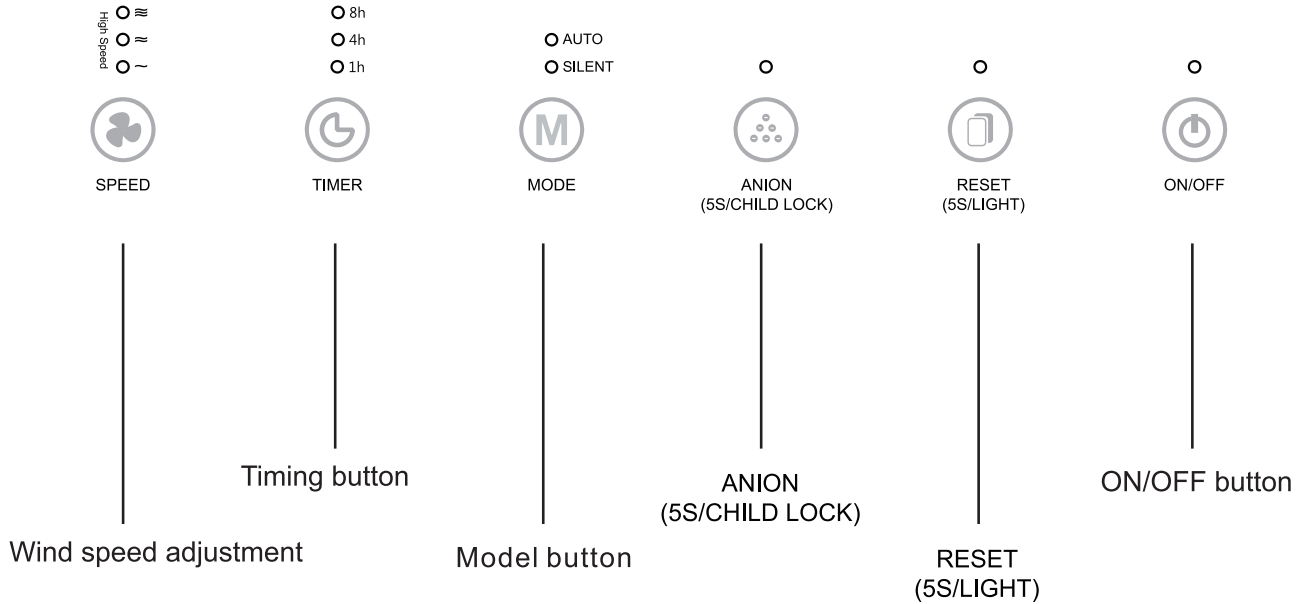

## Other items in packing

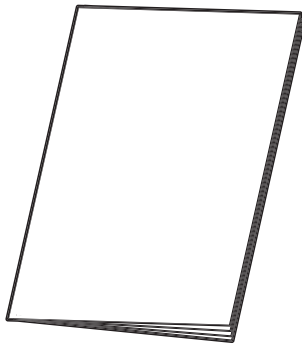

operation manual

### Air quality indicator

	Blue ( PM2.5= 0 ~ 50 )	Perfect
	Green ( PM2.5=50 ~ 100 )	Good
	Purple ( PM2.5= 100 ~ 150 )	Normal
	Red ( PM2.5=150 ~ )	Bad

**Notice: please press the restoration button, if you want to turn off the air quality indicator light.**

## Record the beginning use date in the label

In order to replace the filter on time, before using air purifier, please keep the date recorded in the bottom of the nameplate, thus to achieve the best performance.

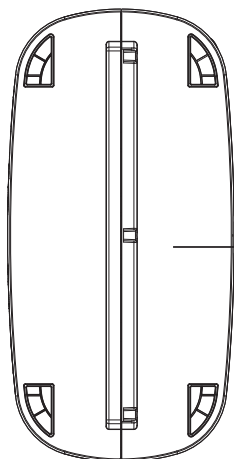

Nameplate and notes

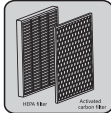
<b>Carrier</b> <b>CB</b>	
MODEL : CARR-AP3601T	POWER SUPPLY : 220V
CADR : 360 CMH	CURRENT : 50HZ
COVERAGE AREA : 28-48 sq.m	POWER INPUT : 30 W
NET WEIGHT : 7.2 kg	NOISE LEVEL : 20-60 dB(A)
SERIAL NO. : 9A800001	
Standard : IEC 60335-2-65:2002, COR1:2004, AMD1:2008 or GB 4706.1-2005, GB 5706-45-2008 (pls. make sure)	
Maintenance and other detailed matters Please refer to the operation instruction.	
 <small>HEPA Filter    Activated carbon Filter</small>	<b>Change records of filters</b>
	Start date: _____
	1st change date: _____
	2nd change date: _____
	3rd change date: _____
	4th change date: _____
5th change date: _____	
<small>SALE AND MARKETED BY: Carrier (Thailand) Ltd. 1858/63-74, 14-15th Floor, Debaratna Road, Km.4.5, Bangna Tai, Bangna, Bangkok 10260 Thailand Tel. 0-2090-9999 Fax: 0-2751-4778</small>	



Noted the start and change date

**Tips**

After removing the plastic package of each filter, the efficient HEPA filter and activated carbon filter must be replaced once a year.

## To know the air quality indicator

Air quality indicator can reflect the air quality conditions, please refer to the specific page 6 and page 14.

Air quality color indicator

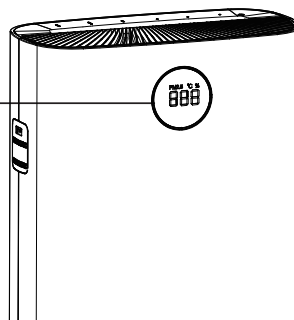



## Method of dismounting and installing

### 1 Method of removing the air inlet Panel.

Hold on the groove at both sides of the air inlet panel, then gently pull it up.

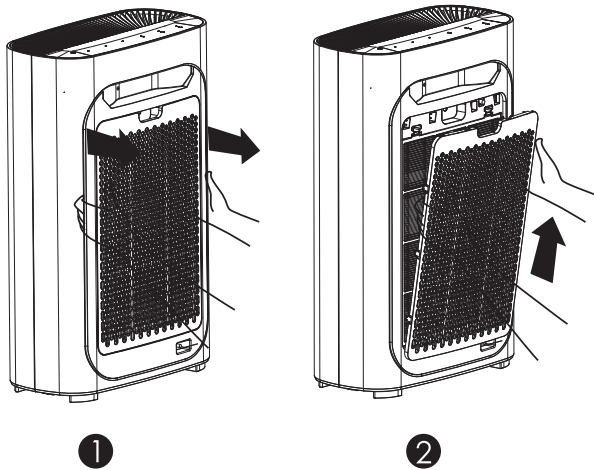

### 2 Method of installing the air inlet panel.

Reinstall the air inlet panel, alignment and insert it into the fixed groove, and then gently push it up.

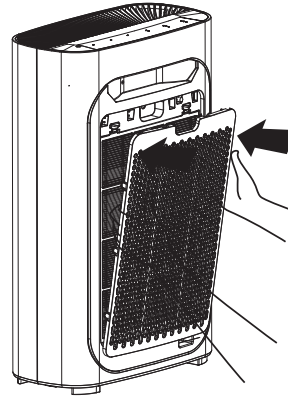

## Placement sites of air purifier

In order to make your room air to achieve good effect on both sides of the cycle, to ensure the gap between the air inlet and the wall at least 50 cm, the air outlet at least 10 cm.

Please keep 1 meters away from television, radio, etc.

Please do not put the power plug together with the television, radio and other electrical power plug inserted into the same socket. (otherwise it may cause screen jitter and noise generated.)

- The long-term placement in the same sites may dirty the host walls.
- To ensure the machines have adequate ventilation and maximum efficiency, don't interfere with the air outlet and air inlet.

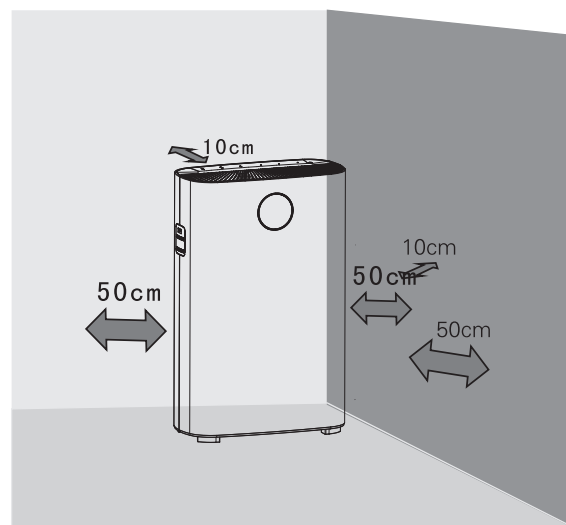

## Install Filter

Please remove all the package of all the filters in the machine before using the air purifier, according to the below instruction.

### ⚡ Attention

- Please make sure the power plugs have been put off before installation, maintenance and transportation.
- Please do not operate the air purifier without the filters.
- Please remove the package of each filter before using.

### 💬 Tips

You can put the purifier on the wall to enhance the stability when removing or installing the filters.

## Steps

Initial use this air purifier, please install the filters correctly as below instructions.

1. Please remove the all packages and put the purifier on the dry, stable, horizontal ground.

2. Hold on the grooves at both sides of the air inlet panel, then gently pull it up.

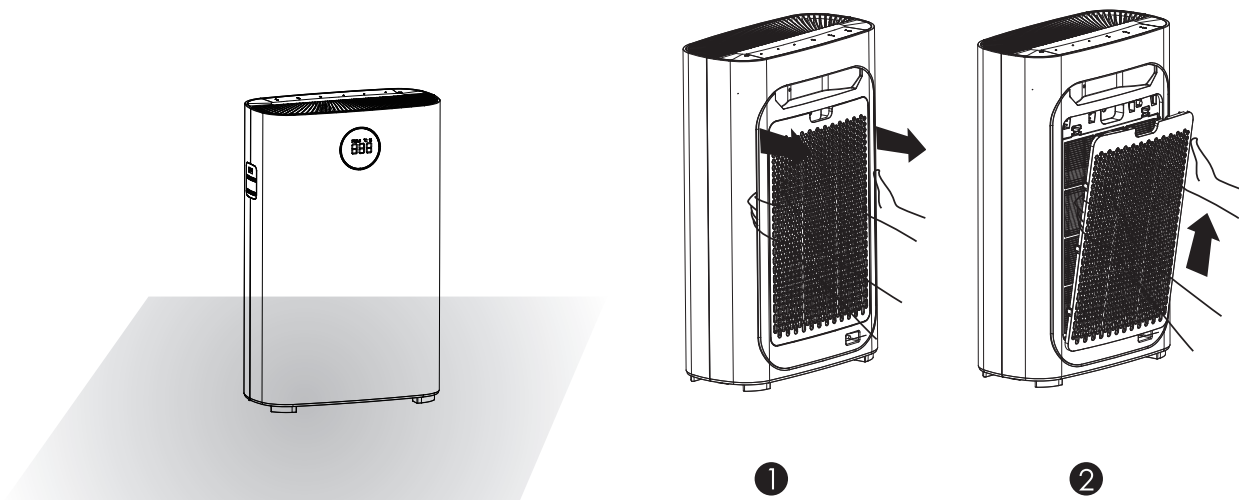

3. Take out all filters from this purifier. 4. Remove all packages.

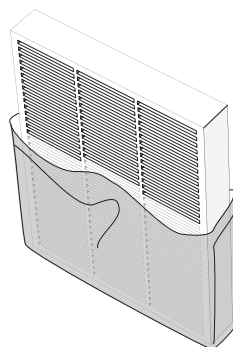
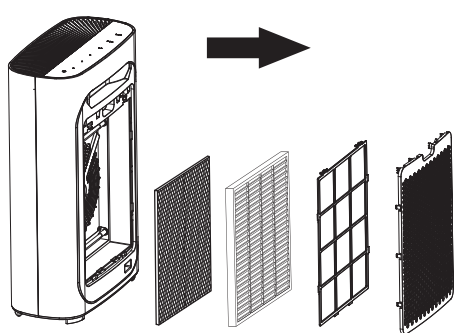

5. Install all the filters in order.

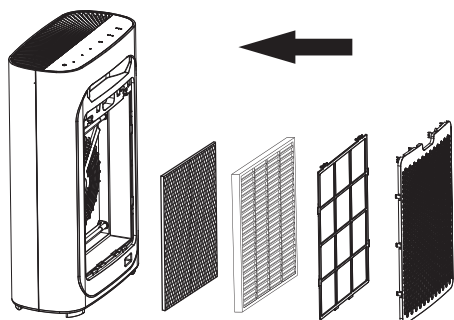

6. Install the pre-filter as the instruction.

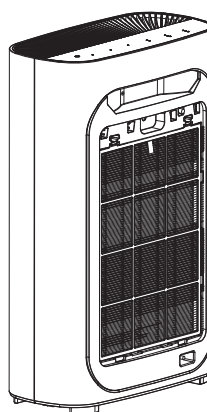

7. Install the air inlet panel again. Align and insert it to the fixed grooves, then gently push it.

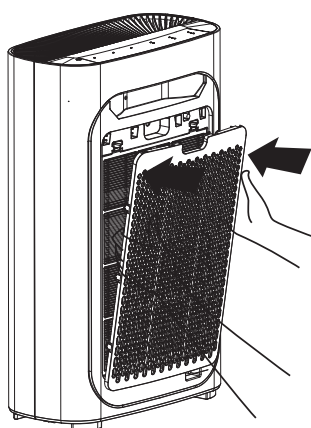

 Tips

Please be carefully when install the front panel.

## Filters and function

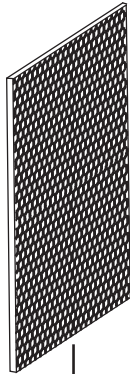

Activated carbon filter

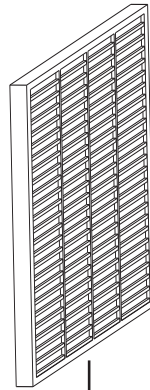

HEPA

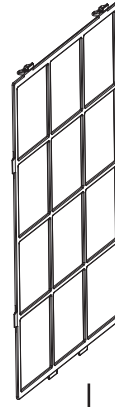

Pre-filter

**3 points purification system, could effectively purify the air, make life more healthy.**

### **One: Pre-filter**

Use micron mesh filter, effectively block 2.5mm fibrous particulate matter, Blocking rate > 99.9%.It can be cleaned easily by tens of thousands times.

Preventing larger particles such as pet fur, dander and coarse dust, etc.  
Can increase the life of the following filters.

### **Two: Efficient HEPA filter**





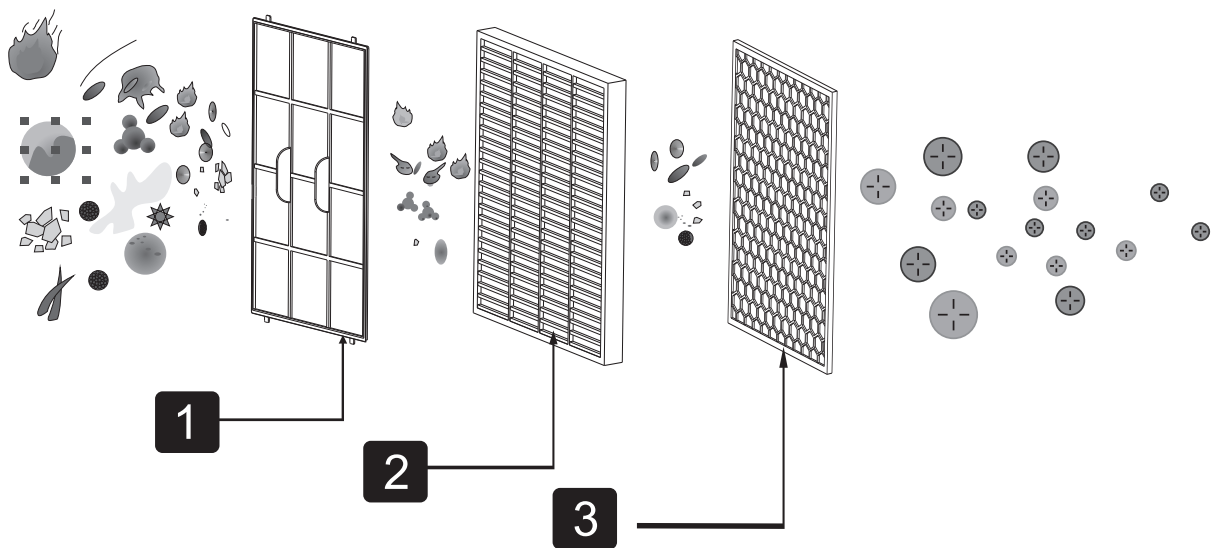

The rate of removing the minor particles small to 0.3 micron from the air flow can up to 95% Spread of allergens and bacteria in air flow, such as pollen, smog and viruses

### **Three: Activated carbon filter**











Removing volatile organic compounds, such as secondhand smoke and kinds of polluting gases.



**+ Bacteria**

			
Yeast	Mycotic spore	Virus	Mildew
			
Mould	Bacteria		

**+ The allergens**

			
Coarse dust	Hair	Harmful particles	Dander
			
Dust	Pollen	Pet fur	Smoke
			
Dust mites	Odor	Chemical substances	

## Control panel

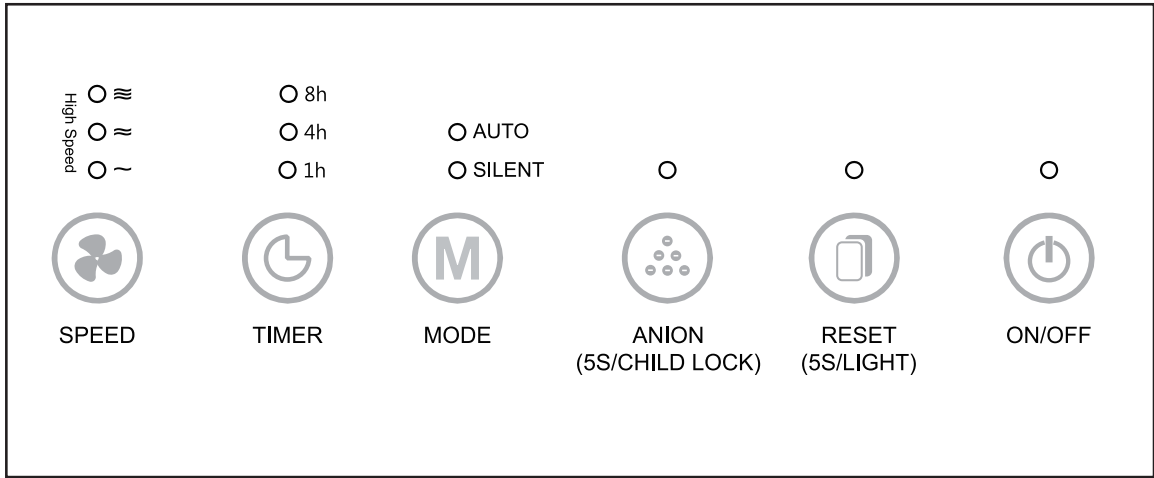

## Plug in the power

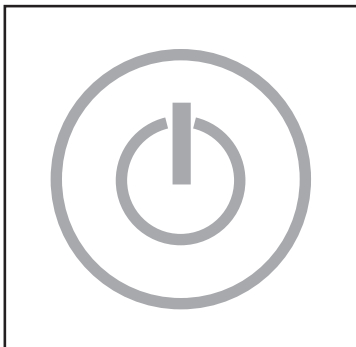
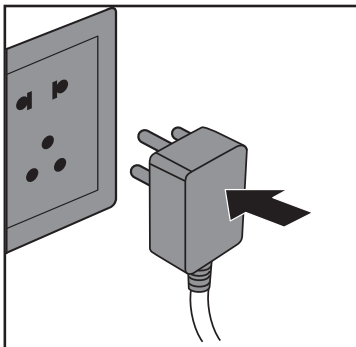

Plug in the power, the music starts and all the lights flash 3 times continuously, then all the lights off, leaving only the power indicator light in red, enter the standby mode.

## Starting air purifier

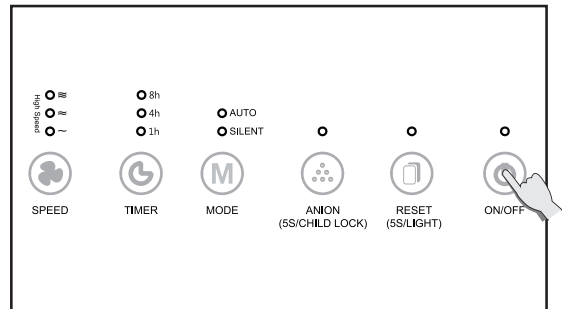



Press the power switch to enter into auto mode with the lights on.

When the machine starts, the air quality indicator light will be slow flashing on, it begins to detect the air quality after preheating for 15 S.

When auto mode starts, it will detect the air quality automatically.

### Air quality indicator

 Blue ( PM2.5= 0 ~ 50 ) Perfect

 Green ( PM2.5=50 ~ 100 ) Good

 Purple ( PM2.5= 100 ~ 150 ) Normal

 Red ( PM2.5=150 ~ ) Bad

**Notice: please press the restoration button, if you need to turn off the air quality sensor light.**

### Auto mode

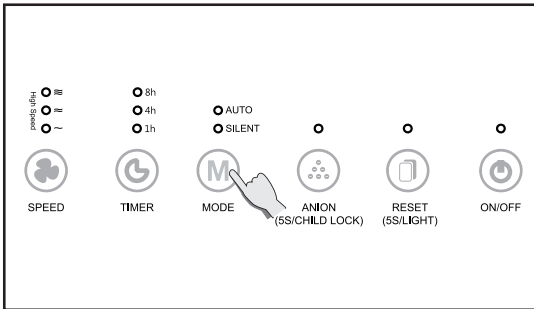

Turning the power on, it will detect the air quality automatically. Choosing the auto mode, will give you the most appropriate fan speed.

### Sleep mode

Sleep mode, has a built-in radial sensor, which will sense the strength of the light. If the light intensity is insufficient, all lights of the machine will be dimmed, and at the same time, the machine automatically changes to silent mode of operation, do not disturb your rest at night.

### Wind Speed adjustment

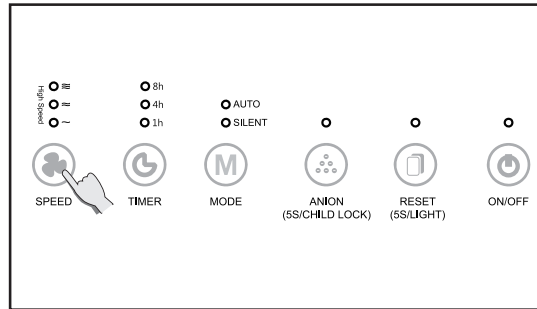

Wind speed can be selected in low, medium and high grade

### Timing function

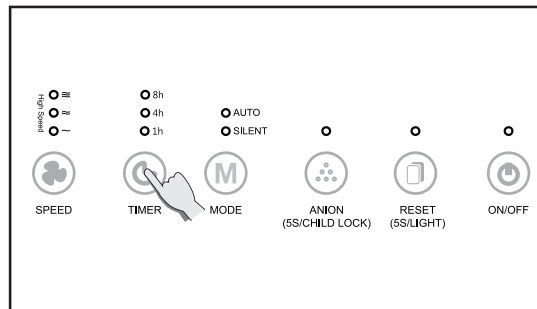

## Anion

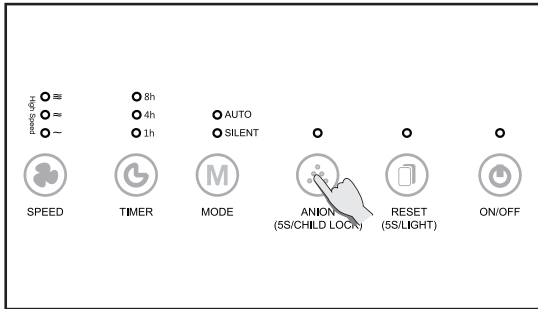

Press and hold for 5 seconds to turn the child lock function on or off

## Reset

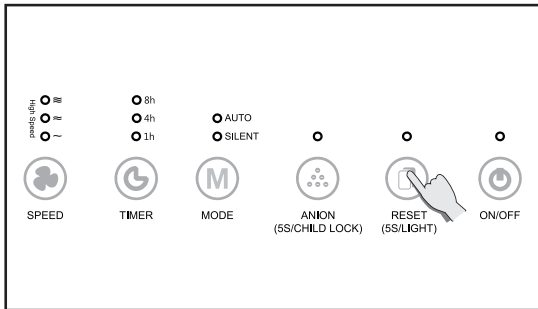

Reset the machine by pressing the button for at least five seconds, (This function is only available after the replacement remind of filter).

## Air quality indicator

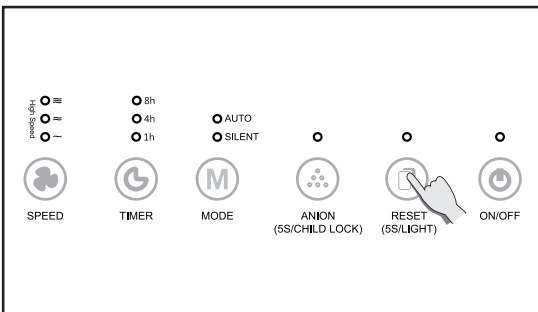

Flip this button to open/close air quality color indicator.

# 5 Cleaning And Maintenance

Be sure to pull out plug before cleaning.

Do not put the product into water or any other liquid. Do not use corrosive or flammable gas (e.g. bleach or alcohol) to clean any part of the product.

Only pre-filter can be cleaned with water, other filter can't.



## Clean air purifier

Clean the medial and lateral regularly to prevent dust accumulation.

- 1 use soft dry cloth to wipe the dust .
- 2 use soft dry cloth to clean inlet and outlet.

## Clean air quality Sensor

Clean the air quality sensor every two months to make sure purifier run at the best performance. If the purifier used in dusty environment, please clean it more often.

### Attention

When the indoor humidity is very high, the air quality indicator may be forming condensate. So even if the air quality is good, air quality indicator may also indicate poor air quality, in this case, you have to clean the air quality indicator or use any manual speed setting.



1.Using a soft brush to clean the inlet/outlet of air quality sensor

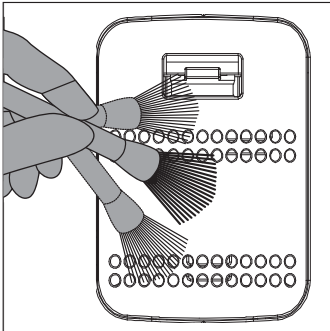

2.Remove the protective cover of air quality sensor.

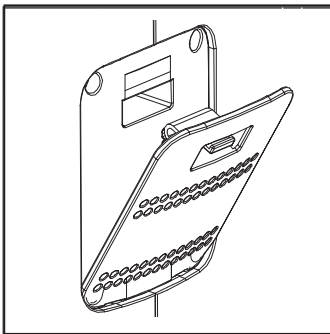

3.Clean the air quality sensor,inlet and outlet with wet cotton swabs slightly

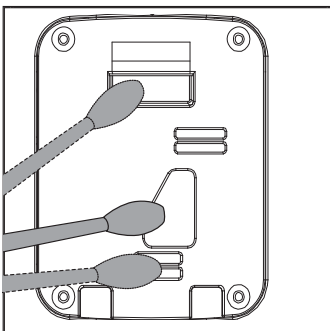

4.Dry it with dry cotton swabs.

5.Remount the protective cover of air quality sensor.

## Clean the pre-filter

### Information

In order to achieve the best performance , clean and maintain the Pre-filter every two months ( about 480 hours ) from the beginning to use.

Based on the average 8 hours a day , 7 days a week frequency , keep the machine working under the household environment.

External maintenance : use wet cloth(or the mild detergent)to wipe the surface to prevent the accumulation of dust.

Turn off the air purifier and pull out the plug before cleaning and maintenance.

Only the Pre-filter can be cleaned,other filters can't.

### ⚡ Attention

**Please use the low power vacuum cleaner, preventing the filter from damage.**

### 💬 Tips

**Before putting each filter into the machine pls remove the plastic packaging, and ensure that the labels on the filters are outwards.**

Operation steps

1. Turn off the power to stop the air purifier.

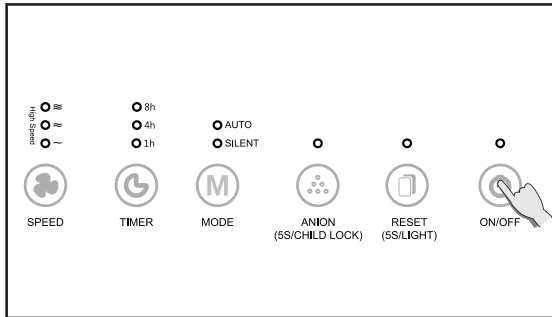

2. Pull out the power plug.

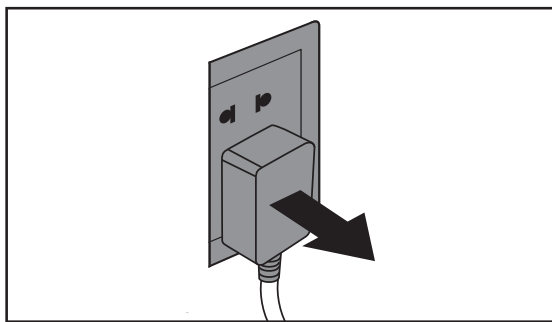

3. Hold on groove at both side of the air inlet panel and pull it outward, then remove it upwards.

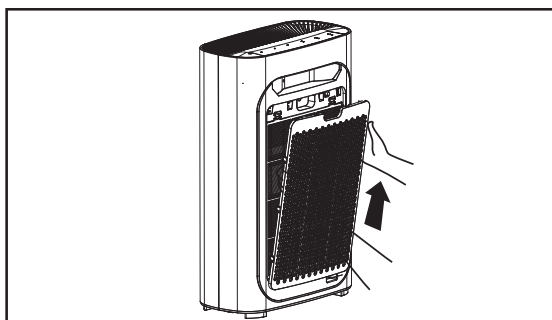

4. Removed the protruding part of the gauze filter before cleaning it.

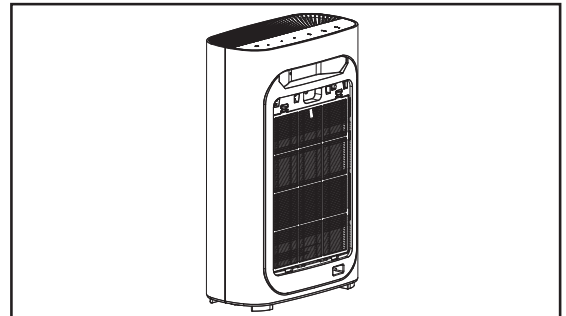

5. Use a soft brush or a vacuum cleaner to remove particles. please use water or soap water to clean the filter. then place it into the machine when it is completely dry

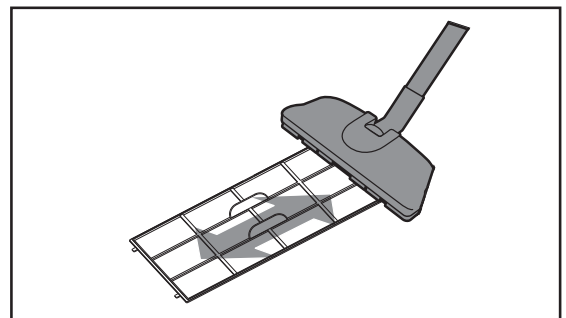

6. Put back the pre-filter into the air purifier.

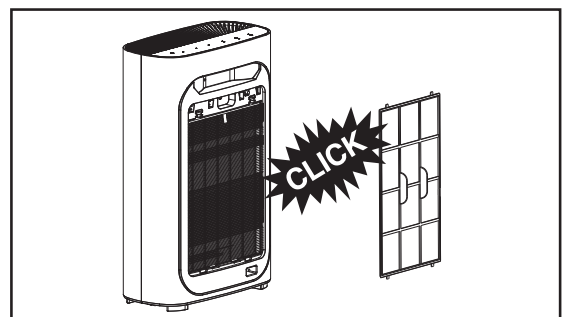

## Replace filters

7.Re-install the air inlet panel, align and insert into the fixed groove, then gently pushed it up.

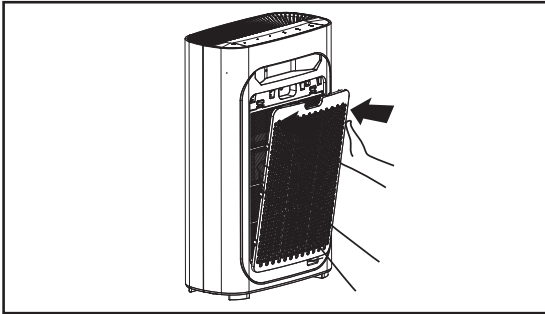

8.Plug in.

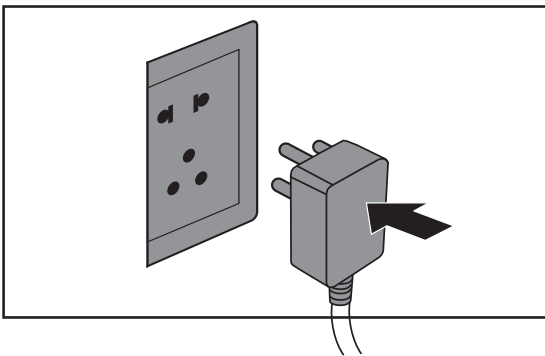

9.Turn on the power and start the air purifier.

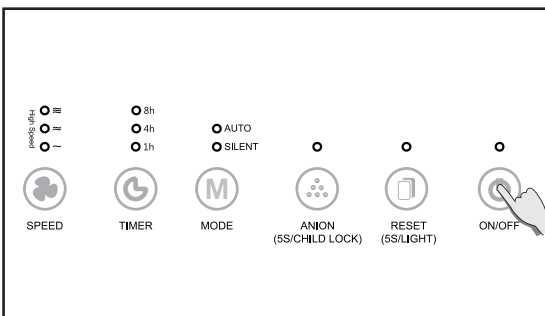

## Information

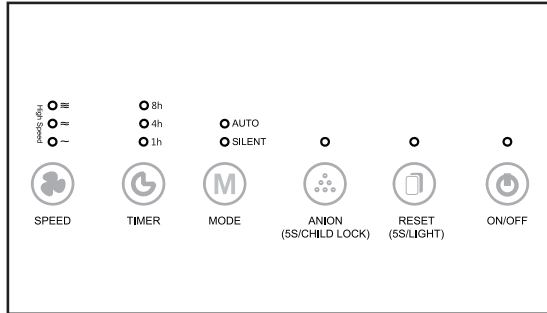

A reminding of filter replacement comes when machine in normal working for more than 1600 hours, and the power lights flash slowly (the red lights flashing, when standby, the blue lights flashing when it is working) .

After the indicator light of replacement of filter shows, the machine can still work.

### ⚡ Attention

**Please turn off the power and pull out the power plug before replacing the filter.**

### 💡 Tips

**Remove all the plastic packaging of each filter before put into machine, To ensure the filter label is outward.**

Operation

1. Reminding to replace the filter.

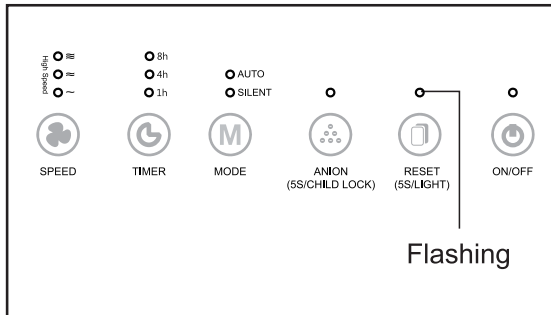

4. Take off all filters inside.

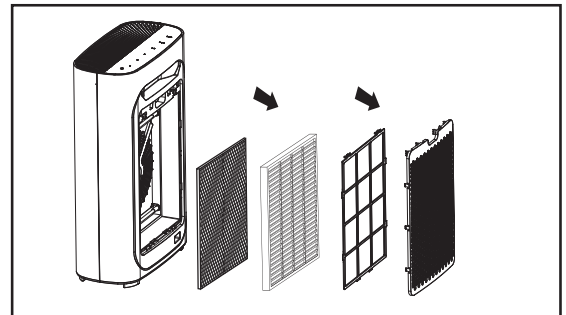

2. Turn off the power, then pull out the power plug.

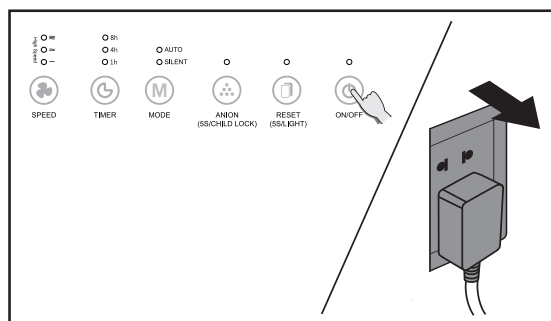

5. Remove all the plastic package of the filters, put back into the purifier.

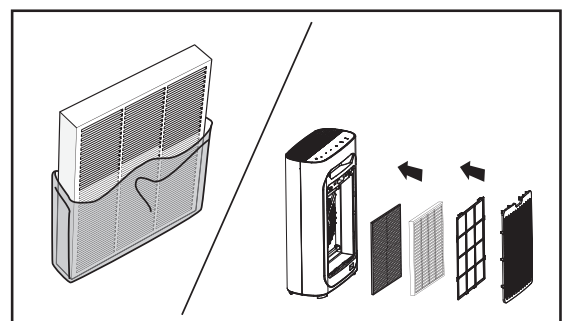

3. Hold on the grooves of both side of the air inlet panel, then gently pull it up.

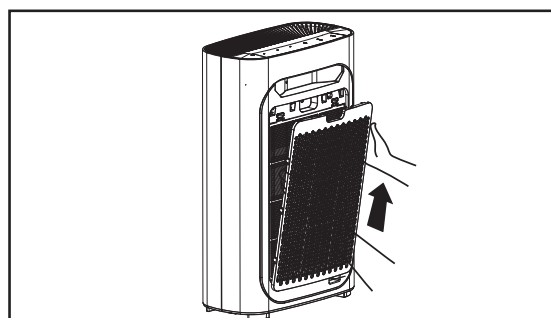

6. Put back the pre-filter into the purifier.

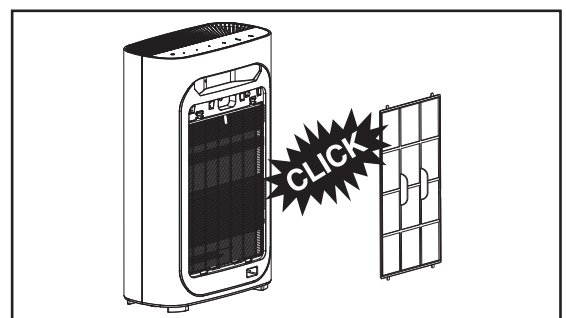

## Unused for a long time

7.Re-install the air inlet panel, align and insert into the fixed groove, then gently pushed it up.

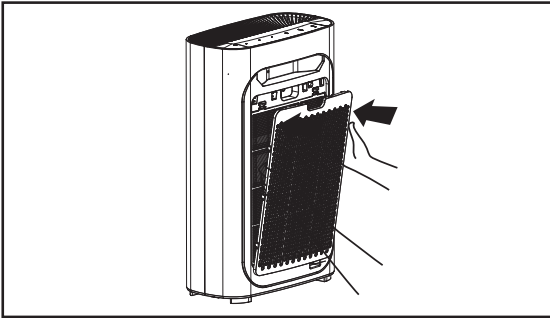

Pull out the power plug.(because the power consumption happened when it is standby.)

Thoroughly dry the inside.(otherwise it may lead to the equipment trouble.)

Store the machine in a dry ventilated place.(lay flat or place upside down may lead to the product trouble.)

## Replace filter reference time

8.After replacing the filter, plug in power , hold on the reset button for 5 seconds, then machine resets.

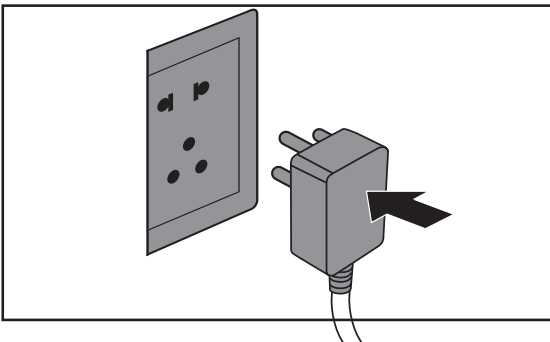

When the total machine work time reach to 1600hours, the machine will notice to change the filter . The power indicator will flash ceaselessly(one time per second). The red light showed when it is standby, the blue light showed when it works. But the machine still can work when get the notice of changing the filter.

### Tips

1.Consider you and your family's health, please change the filter screen in time.

2.After sealing off filter,if the usage time is shorten. But suggest to change one time per six months.

3.After sealing off filters, the filter should be changed one time per 12 months.

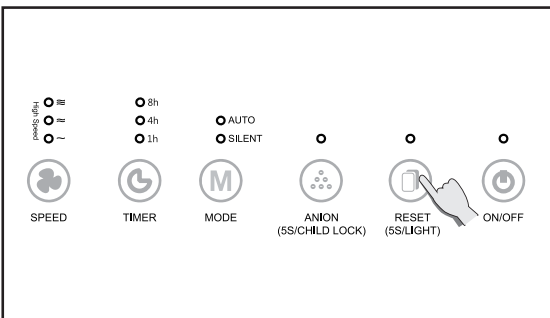

### Attention

**Please turn off or Pull out the plug, before you change the filter .**

## Fault Handling

This chapter list the possible problems when using this product. If you can't solve the problems based on the below information, please contact with our customer center or dealers.

condition	possible reasons	possible solutions
Machine can't turn on	The front panel may not be installed.	To remove the front panel, then install the panel again.
	Power plug is not inserted into the power source	Pull out the power plug, then insert into the power source.
	The power plug or wire is damaged.	Contact with our customer center or dealers.
The fan doesn't work	The machine is not turned on.	Insert the power source,and turn on the machine again.
	The dynamo is damaged.	Contact with our customer center or dealers.
	The machine is put on the uneven place.	Remove the machine to the flat place.
	Loose or foreign particles inside the machine.	Contact with our customer center or dealers.
	The motor is loose.	Contact with our customer center or dealers.
	Plastic packaging of each filter is not removed.	Before using,please remove plastic packaging of each filter.
Performance is poor or not best purification ability	Washable mesh filter is dirty.	Please clean the cleaning mesh filter.
	Filter is not replaced.	Replace one set of new filter.
	Machine inlet or outlet was blocked.	Contact with our customer center or dealers.
	Plastic packaging of each filter is not removed.	Before using,please remove plastic packaging of each filter.
	The gap round the machine is not proper	To ensure the machine at least 50 cm clearance on both sides of the air inlet and the outlet at the back of the machine at least 10 cm.
	Machine filter missing or sequence error	To ensure that all the filters put the correct sequence in machine
	Exceed the expect cover area	To ensure the machine work in the suitable area

## Warranty and service

If you need to understand information or have any questions, you can also contact our customer service center or dealer.

If the product specifications are subject to change, we won't further notice. All trademarks are the property of Yingrui Industries company. Company reserves the right to make changes to the products at any time, without notice, and no obligation to provide earlier products to adjust.

Product warranty terms refer to the instruction attached warranty card in detail.

## Ordering parts or accessories

If you need to replace parts or need to purchase additional parts, please contact your customer service center or dealer.

## Select Accessories

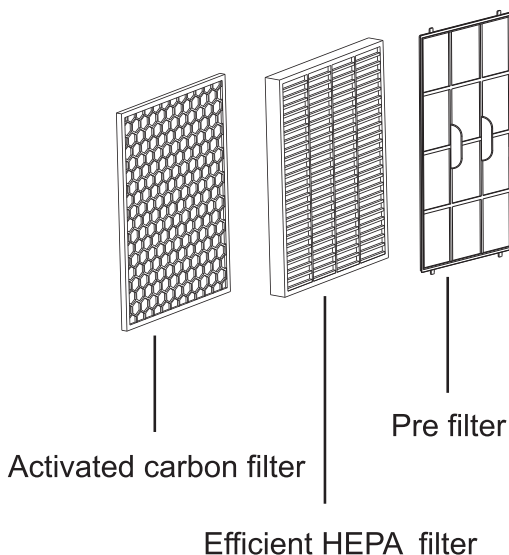

# Additional

## recycling



Place the product, please don't put together with the general life garbage. Please check the local regulations on classified collection of electronic and electrical products.

Right place old product helps to avoid the potential negative effects on the environment and human health.

## Machine parameters

Model: CARR-AP3601T

Rated Voltage: 220 V

Rated frequency: 50 Hz

Rated Power: 30 W

CADR(Partical) : 360 CMH

Noise: 20-60 dB(A)

## Warranty Description

**According to the stipulations of the "new three guarantees", the machine warranty period is one year (from the date of invoice) (warranty range only used for family).**

1. During the warranty period. All that is the quality of the product itself caused by fault, please service with complete product warranty certificate and upgrade free maintenance order of invoice in my company branch.

2. Please keep upgrade invoice as proof of warranty with the warranty certificate, once the invoice is altered, the warranty is invalid.

3. Passed the warranty period, if you need a mail-order products, spare parts, can with your company's customer service mail order, also can buy in the local branch.

4. The customer service such as Zhangjiagang Yingrui Industrial Co., LTD. have an obligation to provide quality services to their customers, customers could complain to customer service directly if without good service.

5. If the specifications have a fixed number of year of the warranty commitment, subject to our manual.

### **Have no free services and repairs if occurred below situation**

1. Without three guarantees proves and effective invoice.

2. The malfunction is caused from operating machine without follow the requirements of specification.

3. One of the following circumstances don't belong to the warranty scope:

**a: Consumers use, custody, maintain improper and cause damage.**

**b: Not the company designated maintenance department to repair damage caused by themselves.**

**c: Damage caused by force majeure.**

4. Products does not belong to the warranty scope, our company's customer service also enthusiasm serving you.



Warranty Card

Product name/item No.		Fuselage number	
-----------------------	--	-----------------	--

Purchase Date	Shop name	Phone number	
			Dealer stamp

Name	
Address	
Mobile Phone	
Zip Code	

Maintenance record

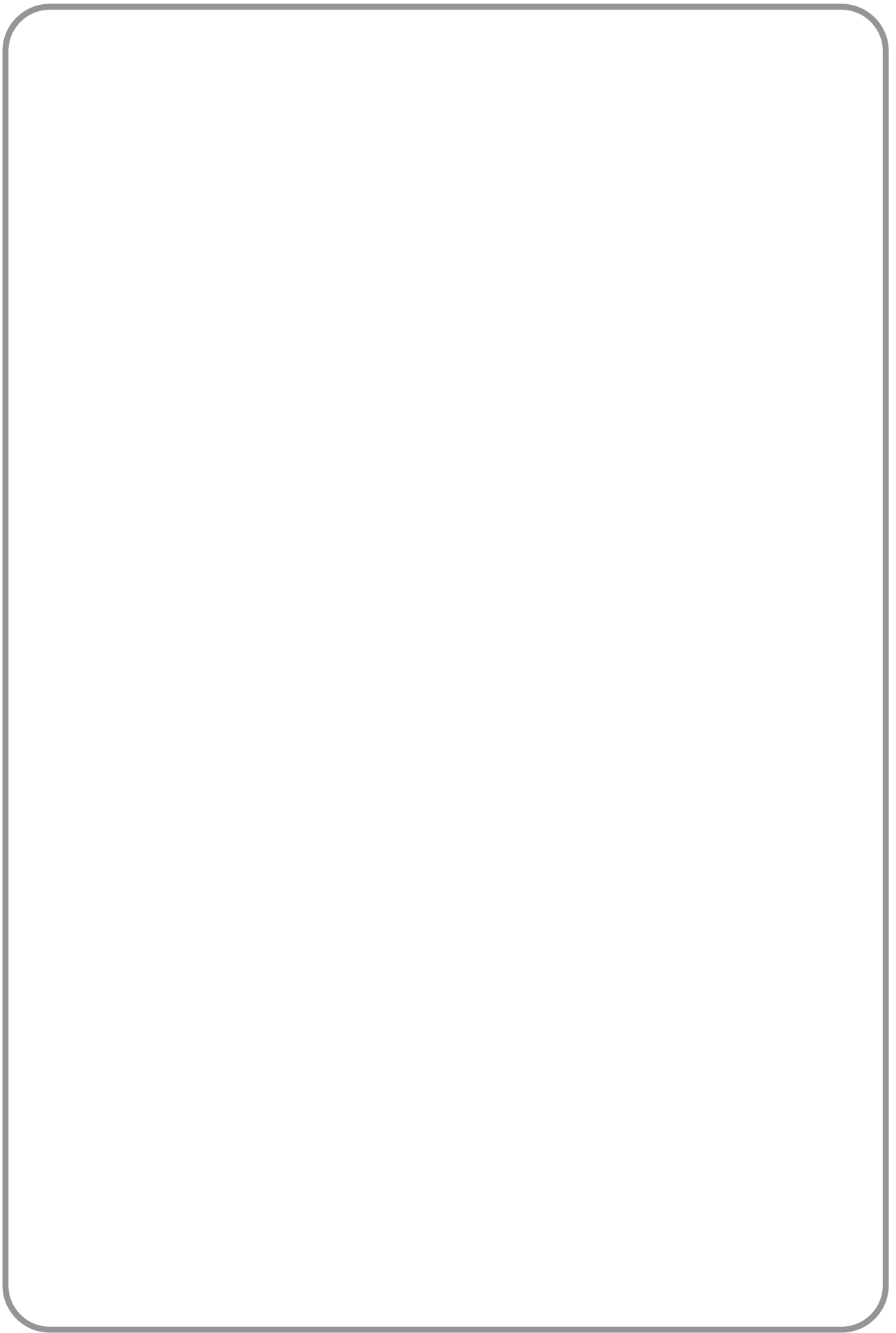

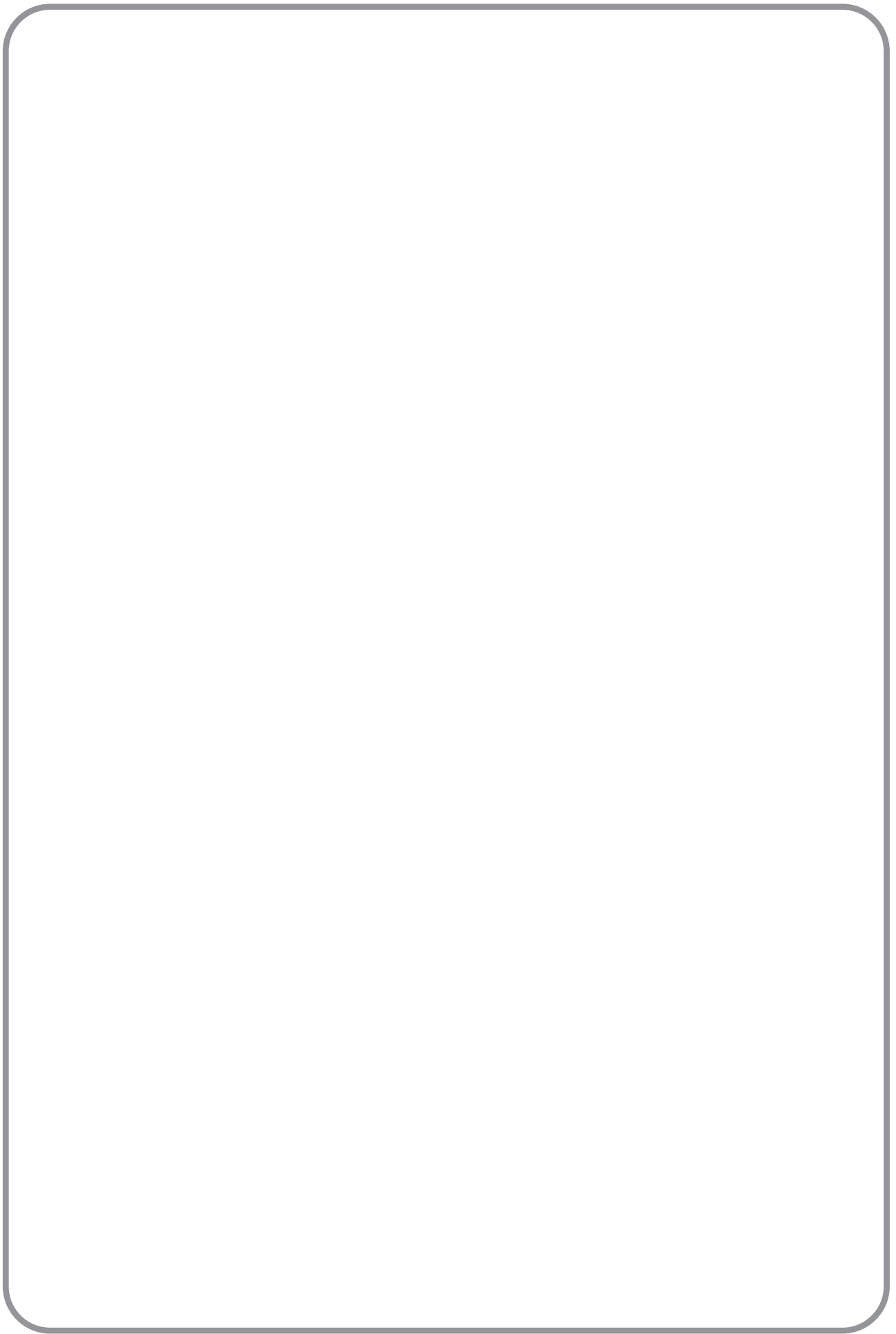

For more details, please contact our Carrier Thailand sales office

SALE AND MARKETED By : Carrier (Thailand) Ltd.

1858/63-74, 14-15th Floor, Debaratna Road, Km.4.5, Bangna Tai, Bangna, Bangkok 10260 Thailand

Tel: 0-2090-9999 Fax: 0-2751-4778



This manual provides certain general information and is intended for guidance only and Carrier is not liable for any damage arising out of the use of the catalogue. The manufacturer reserves the right to change any product specification without prior notice.

All Proprietary Rights Reserved by Carrier.

## Free Manuals Download Website

<http://myh66.com>

<http://usermanuals.us>

<http://www.somanuals.com>

<http://www.4manuals.cc>

<http://www.manual-lib.com>

<http://www.404manual.com>

<http://www.luxmanual.com>

<http://aubethermostatmanual.com>

Golf course search by state

<http://golfingnear.com>

Email search by domain

<http://emailbydomain.com>

Auto manuals search

<http://auto.somanuals.com>

TV manuals search

<http://tv.somanuals.com>