

Please read this manual before using the machine.
Please keep this manual within easy reach for quick reference.

PROGRAMMER

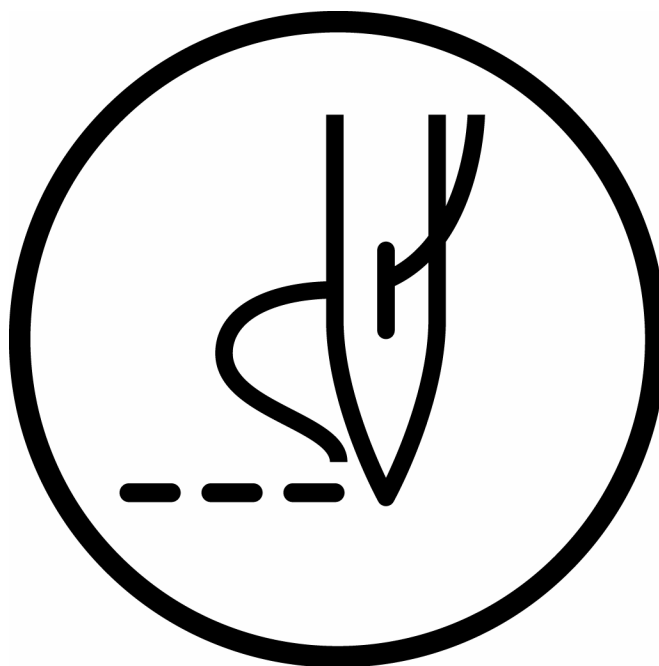

Thank you very much for buying a BROTHER sewing machine. Before using your new machine, please read the safety instructions below and the explanations given in the instruction manual.



With industrial sewing machines, it is normal to carry out work while positioned directly in front of moving parts such as the needle and thread take-up, and consequently there is always a danger of injury that can be caused by these parts. Follow the instructions from training personnel and instructors regarding safe and correct operation before operating the machine so that you will know how to use it correctly.

SAFETY INSTRUCTIONS



1. Safety indications and their meanings



This instruction manual and the indications and symbols that are used on the machine itself are provided in order to ensure safe operation of this machine and to prevent accidents and injury to yourself or other people.



Indications

 WARNING	The instructions which follow this term indicate situations where failure to follow the instructions can result in severe injury or death.
 CAUTION	The instructions which follow this term indicate situations where failure to follow the instructions could cause injury when using the machine or physical damage to equipment and surroundings.

Symbols

 This symbol () indicates something that you should be careful of. The picture inside the triangle indicates the nature of the caution that must be taken.
(For example, the symbol at left means “beware of injury”.)









 This symbol () indicates something that you must not do.

 This symbol () indicates something that you must do. The picture inside the circle indicates the nature of the thing that must be done.
(For example, the symbol at left means “you must make the ground connection”.)





2. Notes on safety

WARNING







Basic precautions

- | | |
|---|--|
| <p> Do not disassemble or modify the programmer, otherwise it may cause fire or electric shocks or problems with correct operation.</p> <p> Ask the place of purchase or a qualified technician to carry out any internal inspections, adjustments or repairs that may be required.</p> <p>(Any problems with correct operation that occur as a result of the customer attempting to disassemble or modify the programmer will not be covered by the warranty.)</p> <p> The bag that the programmer came in should be kept out of the reach of children or disposed of safely. Young children may risk suffocation if they place it over their head while playing with it.</p> <p> Do not handle the programmer or connector for the sewing machine or the AC adapter with wet hands, otherwise it may cause electric shocks.</p> | <p> If the programmer is subjected to a strong force such as by being dropped or stepped on, it may become damaged.</p> <p> If you continue to use the programmer while it is damaged, it may result in fire or electric shocks. If the programmer becomes damaged, immediately disconnect it from the sewing machine (or disconnect the AC adapter from the wall outlet) and contact the place of purchase or a qualified technician.</p> <p> Do not insert objects such as screwdrivers into the AC adapter jack or the CF card slot, otherwise it may cause fire or electric shocks or problems with correct operation.</p> <p>  Disconnect the AC adapter from the wall outlet before disconnecting the AC adapter plug from the programmer, otherwise it may cause electric shocks or problems with correct operation.</p> |
|---|--|

Installation







- | | |
|---|---|
| <p> Do not use any AC adapter other than the one from Brother, otherwise it may cause fire or electric shocks or problems with correct operation.</p> <p></p> <p> When using the AC adapter, do not use any voltage other than the specified voltage, otherwise it may cause fire or electric shocks or problems with correct operation.</p> <p></p> | <p> Do not damage or process the connection cable for the sewing machine or the AC adapter cable, or place heavy objects such as furniture on top of them or bend or pull them with excessive force, otherwise it may cause fire or electric shocks or problems with correct operation.</p> |
|---|---|

During use





- | | |
|---|--|
| <p> If a foreign object gets inside the programmer, immediately disconnect it from the sewing machine (or disconnect the AC adapter from the wall outlet) and contact the place of purchase or a qualified technician. If you continue to use the programmer while there is a foreign object inside it, may result in fire or electric shocks or problems with correct operation.</p> <p></p> <p> Do not allow water or oil to get onto the programmer, otherwise it may cause fire or electric shocks or problems with correct operation.</p> <p> If any liquids get onto the programmer, immediately disconnect it from the sewing machine (or disconnect the AC adapter from the wall outlet) and contact the place of purchase or a qualified technician.</p> | <p> Do not use the programmer if a problem is noticed such as smoke or a bad odor coming from the programmer, otherwise it may cause fire or electric shocks or problems with correct operation.</p> <p> Immediately disconnect the programmer from the sewing machine (or disconnect the AC adapter from the wall outlet) and contact the place of purchase or a qualified technician.</p> <p>(The programmer must never be repaired by the customer, as it can be extremely dangerous to do so.)</p> |
|---|--|

CAUTION





Environmental requirements

-  Use the programmer and the sewing machine in an area which is free from sources of strong electrical noise such as electrical line noise or static electric noise.
Sources of strong electrical noise may cause problems with correct operation of the programmer and the sewing machine.
-  Any fluctuations in the power supply voltage should be within $\pm 10\%$ of the rated voltage for the machine.
Voltage fluctuations which are greater than this may cause problems with correct operation of the programmer and the sewing machine.
-  The power supply capacity should be greater than the requirements for the equipment's power consumption.
Insufficient power supply capacity may cause problems with correct operation of the programmer and the sewing machine.
-  The ambient temperature should be within the range of 5°C to 35°C during use and storage.
Temperatures which are lower or higher than this may cause problems with correct operation of the programmer and the sewing machine.
-  The relative humidity should be within the range of 45% to 85% during use and storage, and no dew formation should occur in any devices.
Excessively dry or humid environments and dew formation may cause problems with correct operation of the programmer and the sewing machine.
-  In the event of an electrical storm, turn off the power and disconnect the power cord from the wall outlet.
Lightning may cause problems with correct operation of the programmer and the sewing machine.

Installation

-  Do not place the programmer on unstable surfaces such as unsteady tables or high shelves, otherwise it may tip over or fall down and cause injury.
-  Do not place heavy objects on top of the programmer, otherwise it may become unbalanced and tip over or fall down and cause injury.
-  Turn off the power switch before connecting and disconnecting the connector for the sewing machine, otherwise it may damage the programmer and the control box.
-  Be sure to disconnect the connector for the sewing machine when using the AC adapter, otherwise it may cause problems with correct operation of the programmer.
- 

During use

-  The programmer and the sewing machine should only be used by operators who have received proper training.
-  Be sure to wear protective goggles when using the sewing machine.
If goggles are not worn, there is the danger that if a needle breaks, parts of the broken needle may enter your eyes and injury may result.
-  When finished with creating programs, disconnect the connector for the sewing machine and store the programmer in a safe place.
If the sewing machine is operated while the programmer is still sitting on the work table, the programmer may fall down and cause injury, or damage to the programmer may result.
-  If a problem occurs with the operation of the programmer or the sewing machine, contact the place of purchase or a qualified technician.

CONTENTS

Chapter 1 Read Me..... 1

Confirming the contents of the box	2
Contents and usage	3

Chapter 2 Setting Up Your Programmer 5

Part names and functions	6
Features	7
Stitch length	7
Stitch count	7
Basic operation	7
Connecting the programmer to the sewing machine	8
Turning the power on.....	8
Turning the power off.....	9
When using the programmer alone.....	10
Precautions on disassembly, assembly, and part replacement.....	10
Making initial settings	11
Making environment settings	12
Functional overview of PD-3000.....	13
Notes on pattern sheet.....	13
About pattern sheet.....	13
Handling media	14
Handling CF cards.....	14
Handling floppy disks.....	16
Applicable types of media.....	17
Setting a medium.....	18
Protecting data in floppy disks.....	20

Chapter 3 Programming with Icons..... 21

Programming with icons.....	22
Keys to be used.....	22
Making environment settings.....	23
Programming screen.....	24
Description of icons.....	24
Procedure for programming with icons	29
Programming example	32
Programming for each stitch	32
Programming a detailed pattern for each stitch (magnified input).....	33
Pattern with lines	33
Pattern with curves	34
Double stitch.....	35
Continuous sewing with the work clamp in position after thread	
trimming (feed).....	36
Basting.....	37
Symmetrical pattern.....	38
Programming different patterns by splitting each in sequence (split).....	39
Zigzag stitch	40
Multiple stitch.....	41
Programming tracing according to a pattern	43
Procedure for modifying program	44
Example of modified program.....	46
Resizing a pattern	46
Modifying a part of pattern.....	47
Deleting the first stitch to change the sewing start point to the position	
of the second stitch	49
Moving the sewing start point	50
Adding a new sewing start point before the first stitch	51
Adding an escape point before the sewing start point.....	52
Moving the escape point.....	54
Deleting the escape point.....	55
Moving the pattern in parallel	
(when the first stitch is the sewing start point).....	56
Moving the pattern in parallel (when the first stitch is the escape point).....	56
Deleting a part of data during programming	58
Moving a part of a continuous program in parallel	59
Moving a part of a continuous program in parallel partially.....	60
Not trimming thread at the last stitch	61



Programming 62



Creating a line.....62



Creating a curve..... 62



Creating a circle..... 63



Creating an arc..... 64



Creating a semicircle..... 64



Creating a zigzag stitch..... 65



Creating a zigzag circle..... 65

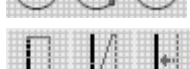

Creating double stitch..... 67



Creating a multiple stitch..... 68



Creating needle drop data..... 68



Creating feed data..... 68



Creating basting data..... 69



Creating trace data..... 69



Checking the program setting and setting attribute..... 69



Editing the current program..... 70



Deleting a part of current data..... 72



Creating a stop stitch..... 73



Creating code..... 74



Making out thread trimming..... 74



Setting out option output..... 74



Low-speed sewing..... 74



Creating split data..... 75



















Basting..... 75



Changing the height of the presser foot..... 76



Changing the thread tension..... 76

	Inputting the trigger.....	76
	Ending programming.....	77
	Checking the program setting and setting attributes.....	78
	Checking each stitch.....	79
	Checking a series of stitches automatically.....	79
	Skipping.....	79
	Editing program.....	81
	If  is selected.....	81
	If    is selected.....	82
	If  is selected.....	82
	If  is selected.....	83
	If  is selected.....	84
	If  is selected.....	84
	If  is selected.....	85
	If  is selected.....	85
	If  is selected.....	85
	If  is selected.....	85
	Deleting program being created/edited.....	86

Chapter 4 Programming with Commands.....	87
Programming with commands.....	88
Keys to be used.....	88
Programming screen.....	89
Description of Commands.....	90
Procedure for programming with commands.....	94
Programming example.....	95
Programming for each stitch.....	95
Programming a detailed pattern for each stitch (magnified input).....	96
Pattern with lines.....	96
Pattern with curves.....	97
Double stitch.....	98
Continuous sewing with the work clamp in position after thread trimming (feed).....	99
Basting.....	100
Symmetrical pattern.....	101
Programming multiple patterns by splitting each in sequence (split).....	102
Zigzag stitch.....	103
Multiple stitch.....	104
Programming by tracing a pattern (trace).....	106
Procedure for modifying program.....	107
Example of modified program.....	108
Resizing a pattern.....	109
Modifying a part of pattern.....	110
Deleting the first stitch to change the second stitch to the sewing start point.....	111
Moving the sewing start point.....	112
Adding a new sewing start point before the first stitch.....	113
Adding an escape point before the sewing start point.....	114
Moving the escape point.....	115

Deleting the escape point.....	116
Moving the pattern in parallel (when the first stitch is the sewing start point).....	116
Moving the pattern in parallel (when the first stitch is the escape point).....	117
Deleting a part of data during programming.....	118
Moving a part of continuous program in parallel.....	119
Not trimming thread at the last stitch.....	119
Programming.....	120
Creating a line.....	120
Creating a curve.....	121
Creating a circle.....	121
Creating an arc.....	123
Creating a semicircle.....	124
Creating a zigzag stitch.....	125
Creating a multiple stitch.....	126
Creating double stitch.....	128
Creating a parallel stitch.....	129
Creating an offset.....	130
Creating feed data.....	130
Creating split data.....	131
Creating magnified data.....	131
Low-speed sewing.....	132
Setting the option output.....	132
Setting the height of presser foot.....	132
Ending programming.....	133
Editing program.....	134
Moving a pattern symmetrically to the Y-axis.....	134
Moving a pattern symmetrically to the X-axis.....	135
Moving a pattern symmetrically to a point.....	135
Rotating a pattern clockwise (counterclockwise).....	136
Copying a rotated pattern rotated clockwise (counterclockwise).....	137
Resizing a pattern.....	138
Copying a pattern resized.....	139
Repeated copying.....	140
Copying a pattern symmetrically to a point.....	140
Copying a pattern symmetrically to the X-axis.....	140
Copying a pattern symmetrically to the Y-axis.....	141
Turnover.....	141
Moving in parallel.....	141
Deleting data being created/edited.....	142
Deleting a part of data.....	142
Deleting program data.....	142
Checking the program setting and setting attribute.....	143

Chapter 5 Extended Option Output..... 145











Function of the extended option output.....	146
Opening the extended option output setting screen.....	146
Items which can be set in the extended option output.....	147
 Setting details of the extended option output.....	147
 Setting enabling conditions.....	148
 Reading the extended option output data.....	148
 Saving the extended option output data.....	149
 Deleting the extended option output data.....	149

Table of condition number.....	150
Mode for operating the sewing machine.....	150
Standard input.....	150
Standard output.....	150
External input of the extended option.....	151
Extended option output.....	151
Table of extended option input.....	152
Table of extended option output.....	153
Examples of the extended option output.....	154
Use of extended option output (Basics).....	157
Use of extended option output (Application).....	164
Use of extended option output (Reference material).....	170

Chapter 6 Reading/Saving/Deleting Program and Formatting Media	173
Procedures for reading/saving/deleting program and formatting media.....	174
Reading program.....	175
 Reading program	175
 Reading additional program	176
 Reading program in a different format	177
Saving program.....	178
 Saving program.....	178
Deleting program	179
 Deleting program saved on a medium	179
Formatting media	181
 Format Formatting media.....	181

Chapter 7 Checking/Copying/Moving/Changing Program	183
Checking program	184
Displaying program information.....	184
Selecting a program display method.....	184
Displaying detailed information of a file	187
Copying/moving/deleting program/renaming a file.....	188
Chapter 8 Displaying Sewing Machine Program	191
Displaying sewing machine program.....	192
Displaying sewing machine program.....	192
Chapter 9 Displaying a Clock	193
Displaying a clock	194
Displaying a clock.....	194
Selecting a clock display method.....	194
Setting a clock.....	195
Additional Information.....	197
Upgrade	198
Troubleshooting.....	198
Memory switch setting display function	199
Error log display function.....	200
Spare parts	201

Chapter 1

Read Me

Confirming the contents of the box

Open the box and make sure all the following items are in it.

1. Programmer main unit

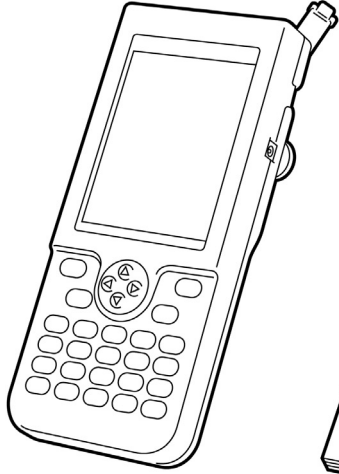

2. Basic operation manual

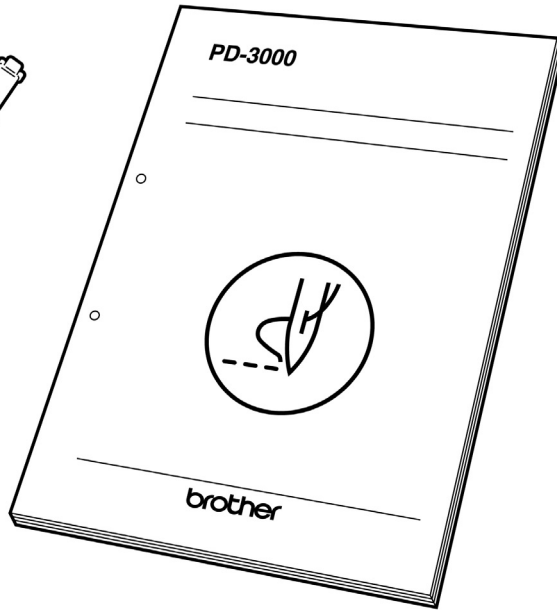

3. Document CD
(Manual CD-ROM)

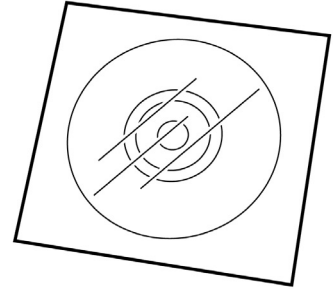

Contents and usage

This document is organized as follows.

Chapter 1 Read Me

Describes general precautions.

Chapter 2 Setting Up Your Programmer

Describes how to set up your programmer and its basic operations.

Chapter 3 Programming with Icons (PROGRAM)

Describes how to create programs with icons. It is recommended for persons

- who are familiar with icon entry,
- who use this sewing machine for the first time, and
- who sometimes create programs.

Chapter 4 Programming with Commands (PROGRAM)

Describes how to create programs with commands consisting of numerics and characters.

It is recommended for persons

- who is specially responsible for program creation, and
- who have created programs for BAS-300 series.

Chapter 5 Extended Option Output (PROGRAM)

Describes how to set the extended option output.

Chapter 6 Reading/Saving/Deleting Program and Formatting Media (PROGRAM)

Describes how to read, save, and delete program data, and format media.

Chapter 7 Checking/Copying/Moving/Changing Program (FILE)

Describes how to check, copy, move, and change program data.

Chapter 8 Displaying Sewing Machine Program (PANEL)

Describes how to display program of the sewing machine.

Chapter 9 Displaying a Clock (CLOCK)

Describes how to display and set a clock.

Additional Information

Chapter 2

Setting Up Your Programmer

Part names and functions

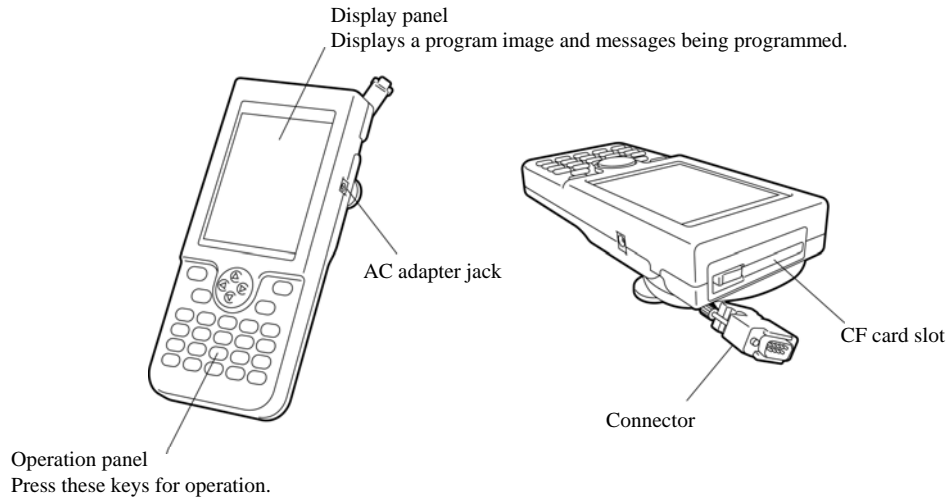

Operation panel key



Example of the use of a strap

A strap is not provided as a standard accessory.

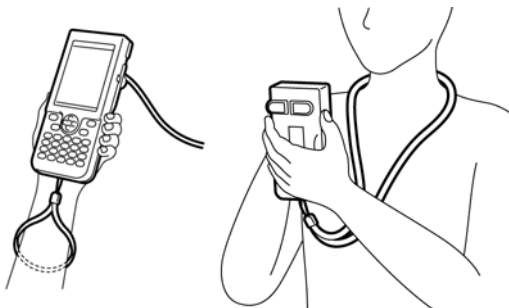

After use

Wind the cable as shown in the figure.

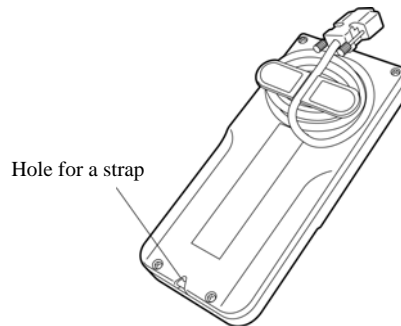

After using the programmer, keep it in a safe place.

Features

Stitch length

Can be set in the range 0.3 to 12.7 mm

Stitch count

The maximum stitch count per data is 20,000. (The sewing machine can hold 512 patterns and the CF card can hold 900 patterns. The holdable number of patterns created using a large number of stitches per data may be less.)

Basic operation

WARNING



Do not handle the programmer or connector for the sewing machine or the AC adapter with wet hands, otherwise it may cause electric shocks.



Do not insert objects such as screwdrivers into the AC adapter jack or the CF card slot, otherwise it may cause fire or electric shocks or problems with correct operation.



Do not use any AC adapter other than the one from Brother, otherwise it may cause fire or electric shocks or problems with correct operation.



When using the AC adapter, do not use any voltage other than the specified voltage, otherwise it may cause fire or electric shocks or problems with correct operation.



If a foreign object gets inside the programmer, immediately disconnect it from the sewing machine (or disconnect the AC adapter from the wall outlet) and contact the place of purchase or a qualified technician. If you continue to use the programmer while there is a foreign object inside it, may result in fire or electric shocks or problems with correct operation.



Disconnect the AC adapter from the wall outlet before disconnecting the AC adapter plug from the programmer, otherwise it may cause electric shocks or problems with correct operation.



Do not damage or process the connection cable for the sewing machine or the AC adapter cable, or place heavy objects such as furniture on top of them or bend or pull them with excessive force, otherwise it may cause fire or electric shocks or problems with correct operation.



Do not use the programmer if a problem is noticed such as smoke or a bad odor coming from the programmer, otherwise it may cause fire or electric shocks or problems with correct operation.



Immediately disconnect the programmer from the sewing machine (or disconnect the AC adapter from the wall outlet) and contact the place of purchase or a qualified technician.

(The programmer must never be repaired by the customer, as it can be extremely dangerous to do so.)

CAUTION



Do not place the programmer on unstable surfaces such as unsteady tables or high shelves, otherwise it may tip over or fall down and cause injury.



Do not place heavy objects on top of the programmer, otherwise it may become unbalanced and tip over or fall down and cause injury.



The programmer and the sewing machine should only be used by operators who have received proper training.



Turn off the power switch before connecting and disconnecting the connector for the sewing machine, otherwise it may damage the programmer and the control box.



Be sure to disconnect the connector for the sewing machine when using the AC adapter, otherwise it may cause problems with correct operation of the programmer.



When finished with creating programs, disconnect the connector for the sewing machine and store the programmer in a safe place.

If the sewing machine is operated while the programmer is still sitting on the work table, the programmer may fall down and cause injury, or damage to the programmer may result.

Connecting the programmer to the sewing machine

This section describes how to connect the programmer to the sewing machine.

Check that the sewing machine is off before connecting the cable.

1. Connect the cable to the connector on the left side of the operation panel.

Fasten the screws securely.

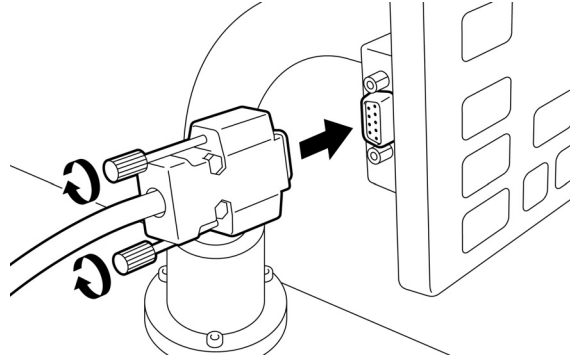

Turning the power on

1. Switch on the sewing machine.

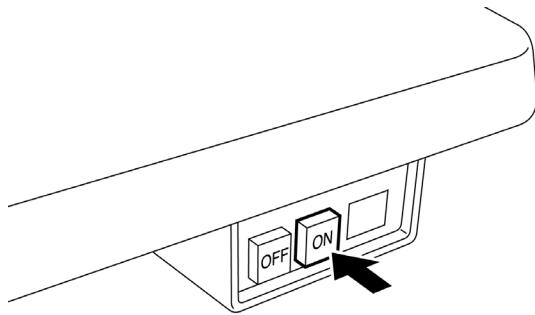

2. Set a pattern sheet.

For preventing the pattern sheet from moving, secure it by using adhesive tape.

3. Press  of the programmer.

Turning the power off

1. Write the program of the programmer to a medium.

See "Saving program" (page 178).

If there is no need to save the program, delete it.

See "Deleting program saved on a medium" (page 179).

2. Press  of the programmer.

The panel is turned off.

3. Press the foot switch pedal to raise the work clamp.

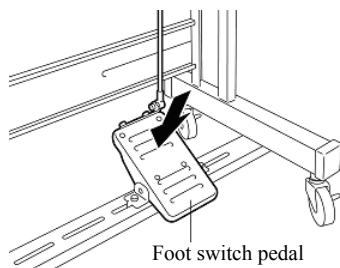
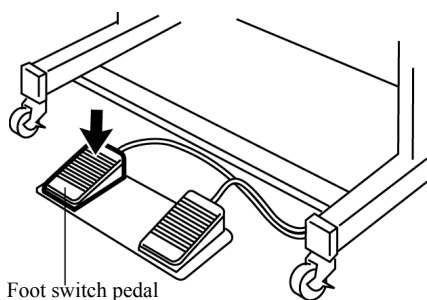

4. Remove the pattern sheet.
5. Switch off the sewing machine.

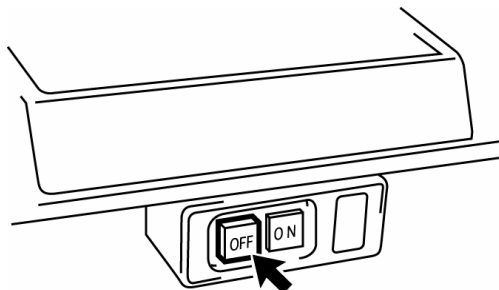

When using the programmer alone

Purchase an AC adaptor conforming to the specifications below.

OUTPUT: 24 VDC, 0.5A

Polarity: 

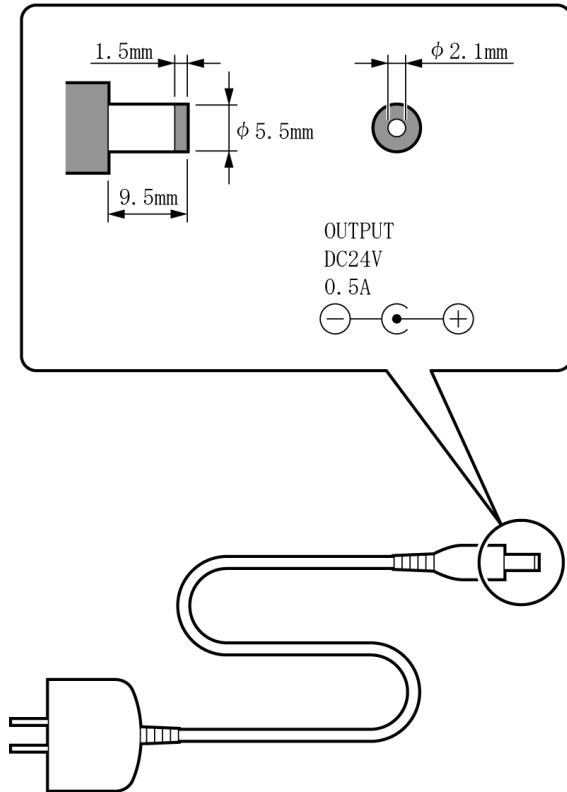

Precautions on disassembly, assembly, and part replacement

WARNING



Do not disassemble or modify the programmer, otherwise it may cause fire or electric shocks or problems with correct operation.
Ask the place of purchase or a qualified technician to carry out any internal inspections, adjustments or repairs that may be required.

(Any problems with correct operation that occur as a result of the customer attempting to disassemble or modify the programmer will not be covered by the warranty.)

- For preventing the internal wiring from being damaged, considerable care must be taken when assembling and disassembling the case.
- For preventing the internal wiring from getting caught in the case or other parts, care must be taken when assembling the case.
- Be sure to use a torque of 0.5 N/m when tightening screws.

Using excessive torque may damage the case.

Making initial settings

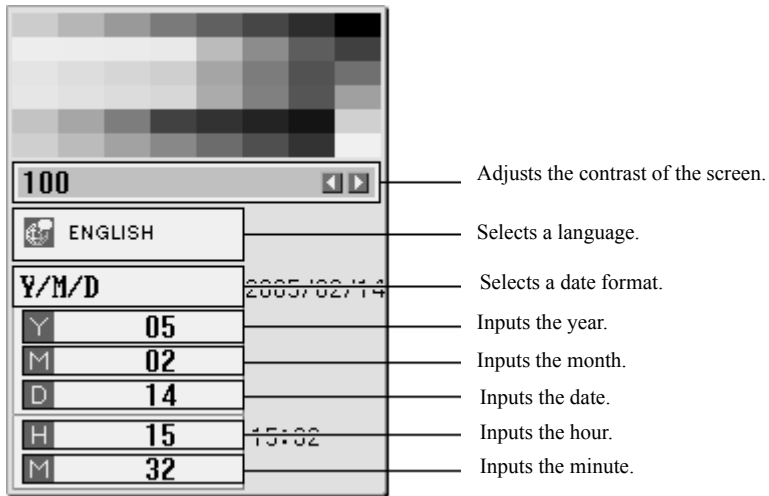

If the following menu is displayed at power-up, make an entry at every item by using $\Delta \nabla \leftarrow \rightarrow$ and the numeric keys.

When the setting has been completed, press \leftarrow .





Making environment settings

To change the environment settings during the setting process,

1. Select  on the launcher screen. Press .



2. Select  by using . Press .

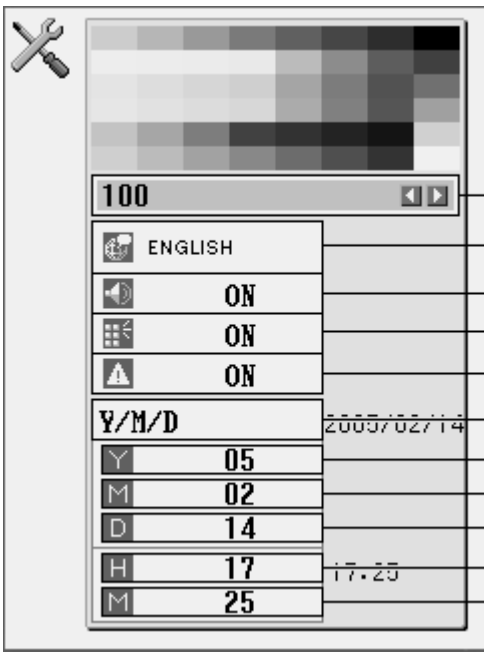

- Adjusts the contrast of the screen.
- Selects a language.
- Switches between ON and OFF of the buzzer sound.
- Switches between ON and OFF of the key click sound.
- Switches between ON and OFF of the warning display.
- Selects a date format.
- Inputs the year.
- Inputs the month.
- Inputs the date.
- Inputs the hour.
- Inputs the minute.

Functional overview of PD-3000

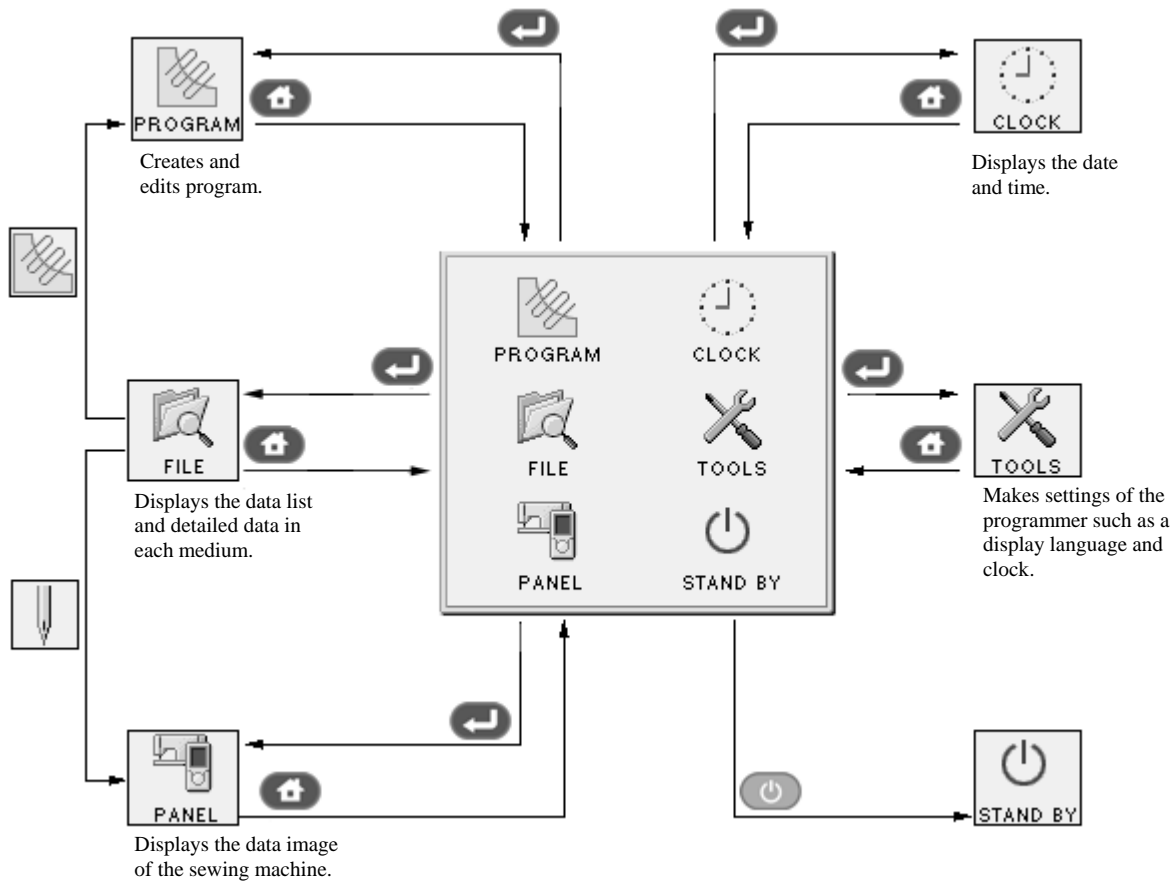

Notes on pattern sheet

About pattern sheet

- Write a pattern on thin plotting paper or use copies of pattern sheet.
- Design pattern sheet in full scale. Adjust the size to magnification (2, 5, or 10) when using the magnified input.

**WARNING**

Do not insert objects such as screwdrivers into the CF card and the floppy disk slot, otherwise it may cause fire or electric shocks or problems with correct operation.

Handling CF cards

■ Precautions on handling CF cards (commercial items)

- Use CF cards of 32, 64, 128, or 256 MB.
- Do not disassemble or modify CF cards.
- Do not bend CF cards with excessive force, drop or damage them, or put any heavy item on them.
- Do not subject CF cards to any kind of liquid such as water, oil, solvent, and drink.
- Use and store CF cards in an environment where no strong static electricity and electric noise are generated.
- Do not use or store CF cards in a place subject to vibrations, impacts, direct sunlight, lint and dust, high-temperature and humidity, big difference in temperature, or strong magnetism generated by a loudspeaker or the like.
- Do not subject a CF card to vibrations or impacts or take it out from the sewing machine during reading or writing data.
- The data in CF cards may be lost or damaged by wrong operation or an accident. We recommend you to produce backups of important data.
- Be sure to turn off the sewing machine before loading and ejecting a CF card.
- Commercially available CF cards are preformatted. Do not format them again.
- Recommended CF cards are commercially available ones from SanDisk and Hagiwawa Sys-Com. Though products from other manufacturers are also available, in some cases, you cannot read and write data on them due to the difference in their formats.

Also, read the instruction manual attached to the CF card you purchased.

- * This programmer is compatible with CF cards of FAT16 format, but not compatible with ones of FAT 32 format.
- * CF™ is a trademark of SanDisk Corporation.
- * Company names and product names in this document are trademarks of their respective companies. Any mark such TM is not given in the main body of the document.

■ Configuration of the CF card folder

```

\BROTHER\ISM\ISMSYS \ISM02MN.MOT : Control program
\BROTHER\ISM\ISMDB00\ISMMSW.SEW : Memory switch data
    *1 \ISMUPG.SEW : User program data
        \SMHST.SEW : Error log data
            \SMS0100.SEW : Sewing data P No.=100
            \SMS0101.SEW : Sewing data P No.=101
            \SMS0102.SEW : Sewing data P No.=102
  
```

- *1 If you change the numeric values of the memory switch No. 752, the underlined number is changed. By this procedure, you can change the name of the folder \BROTHER\ISM\ISMDB00 which holds data per sewing. To manage sewing data of different sewing machines in one CF card, change the folder name.

Handling floppy disks

Do not directly touch the magnetic surface by opening the shutter needlessly.

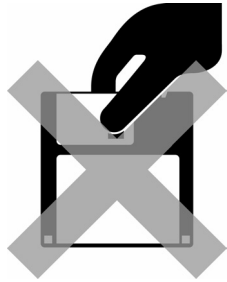

Do not bring disks near magnetic matters such as a magnetic screwdriver or the back side of the programmer.



Do not store floppy disks in a place subject to high or low ambient temperature.

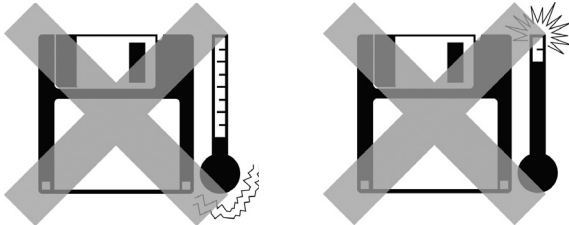

Do not use floppy disks under high humidity.



Do not use or store floppy disks in a dusty place.

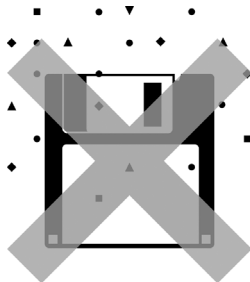

Do not store floppy disks subject to direct sunlight.

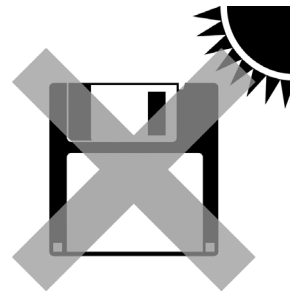

Do not bend floppy disks. Do not put things on them.



Do not subject floppy disks to solvent or drink.



Do not eject a floppy disk from the slot during the access lamp is lit.

Applicable types of media

Data type (*1)	Stitch count which can be stored	Data resolution	Medium	Format	Write
BAS-300G data	20000 stitches/pattern 900 patterns Holdable sum total of patterns depends on the capacity of the CF card. Approx. 7.9 million stitches for a CF card of 32 MB.	0.05 mm/pulse (*4)	CF card	FAT16	Available
BAS-300E Data (BAS-300F, KE-436B, 436C)	20000 stitches/pattern 100 patterns Up to 360,000 stitches in total	0.05 mm/pulse (*4)	2HD floppy disk	1.44M for DOS/V	Available
TFD embroidery data (*2) (DST, DSB, DSZ)	20,000 stitches/pattern	0.1 mm/pulse	CF card	FAT16	Not available
Former BAS-300A data	4000 stitches/pattern 10 patterns Up to 40,000 stitches in total	0.1 mm/pulse	2DD floppy disk (*3)	Formatted automatically.	Available
Former BAS-300 data	2000 stitches/pattern 10 patterns Up to 20,000 stitches in total	0.2 mm/pulse			Not available

(*1) Five types of data above can be read. Data written on 2HD and 2DD disks are automatically converted to BAS-300E and former BAS-300A data respectively.

(*2) TFD embroidery data is converted to BAS-300G data by the programmer and becomes available for sewing.

(*3) Restrictions when using a 2DD

To keep compatibility with the former BAS-300A data, functions added to E series are subject to restrictions as shown below.

(*4) KE-436B and 436C are restricted to data resolution of 0.1 mm/pulse at the sewing machine side.

Restricted functions	A series (2DD)	E and F series (2HD)	KE-436B, 436C(2HD)	G series (CF card)	Corresponding commands
Resolution	0.1mm/pulse	0.05mm/pulse	0.1 mm/pulse	0.05 mm/pulse	
Low-speed sewing	2 options: 400 and 1200 rpm	4 options: 400, 600, 800, 1200 rpm			
Split function during sewing	No	Yes			
Stoppage of split with the needle at the lower end	No	Yes			
Extended option output	No	Yes	No	Yes	

Setting a medium

■ CF card (to the programmer)

When loading a CF card onto the programmer,

1. Turn off the programmer.
2. Load a CF card into the CF slot in correct orientation.

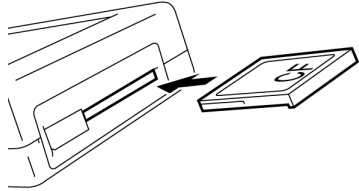

When ejecting the CF card from the programmer,

1. Raise the eject lever.

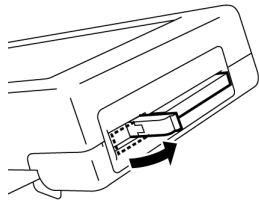

2. Press the eject lever to eject the CF card.

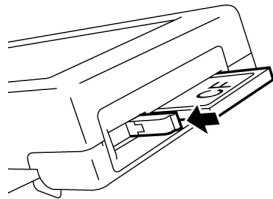

Caution

- Do not eject the CF card during writing or reading program. This may lead to program corruption.

■ CF card (to the sewing machine)

When loading a CF card onto the sewing machine,

1. Turn off the sewing machine.
2. Load a CF card into the CF slot in correct orientation.

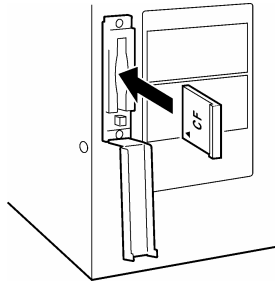

Caution

- Be sure to load a CF card into the CF slot in correct orientation.
- The lid of the CF slot must be closed except when loading or ejecting a CF card. Dust intrusion may cause malfunctions.
- When no enabled data is found, the CF lamp does not light.

When ejecting the CF card from the sewing machine,

1. Press the eject lever to eject the CF card.

Caution

- Do not eject the CF card during writing or reading data. This may lead to data corruption.

■ Floppy disk (FD)

When setting a floppy disk, insert it straight into the slot with the label side upward.

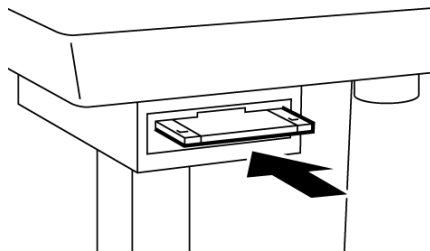

When removing the floppy disk, press the eject switch.

Do not press the eject switch during the access lamp is lit. This may lead to data corruption.

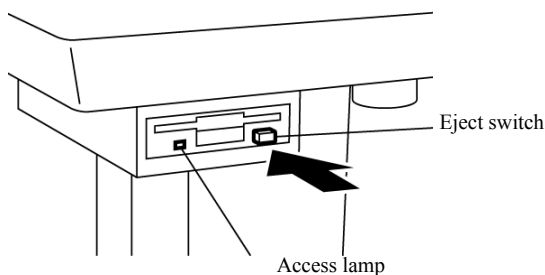

Protecting data in floppy disks

Floppy disks are provided with a write-protect to prevent data from deleting accidentally.

Write-protected disks are for read-only. You are recommended to write-protect floppy disks holding important data.

To enable the write-protect, slide the write-protect notch to the side where a square hole shows up.

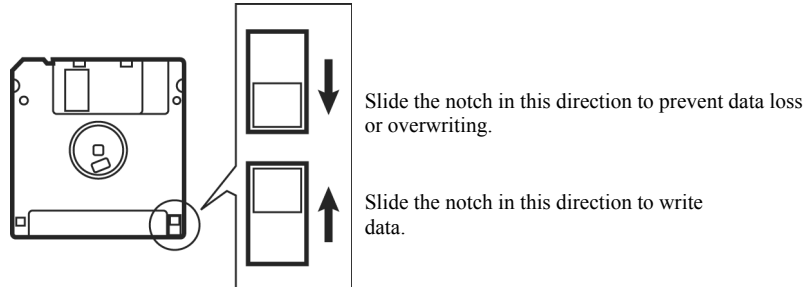

Chapter 3

Programming with Icons

Programming with icons

While being operated by the programmer, a number of icons are displayed on the screen which illustrate its operations and functions.

This chapter describes the procedure for programming with icons.

* Other than programming with the icons, programming with commands is also possible. Holding  down allows the user to switch between the mode for programming with icons and the mode for programming with commands.

⇒ Refer to Chapter 4 "Programming with Commands" (page 88).

Keys to be used

This section describes keys to be used for programming with icons.

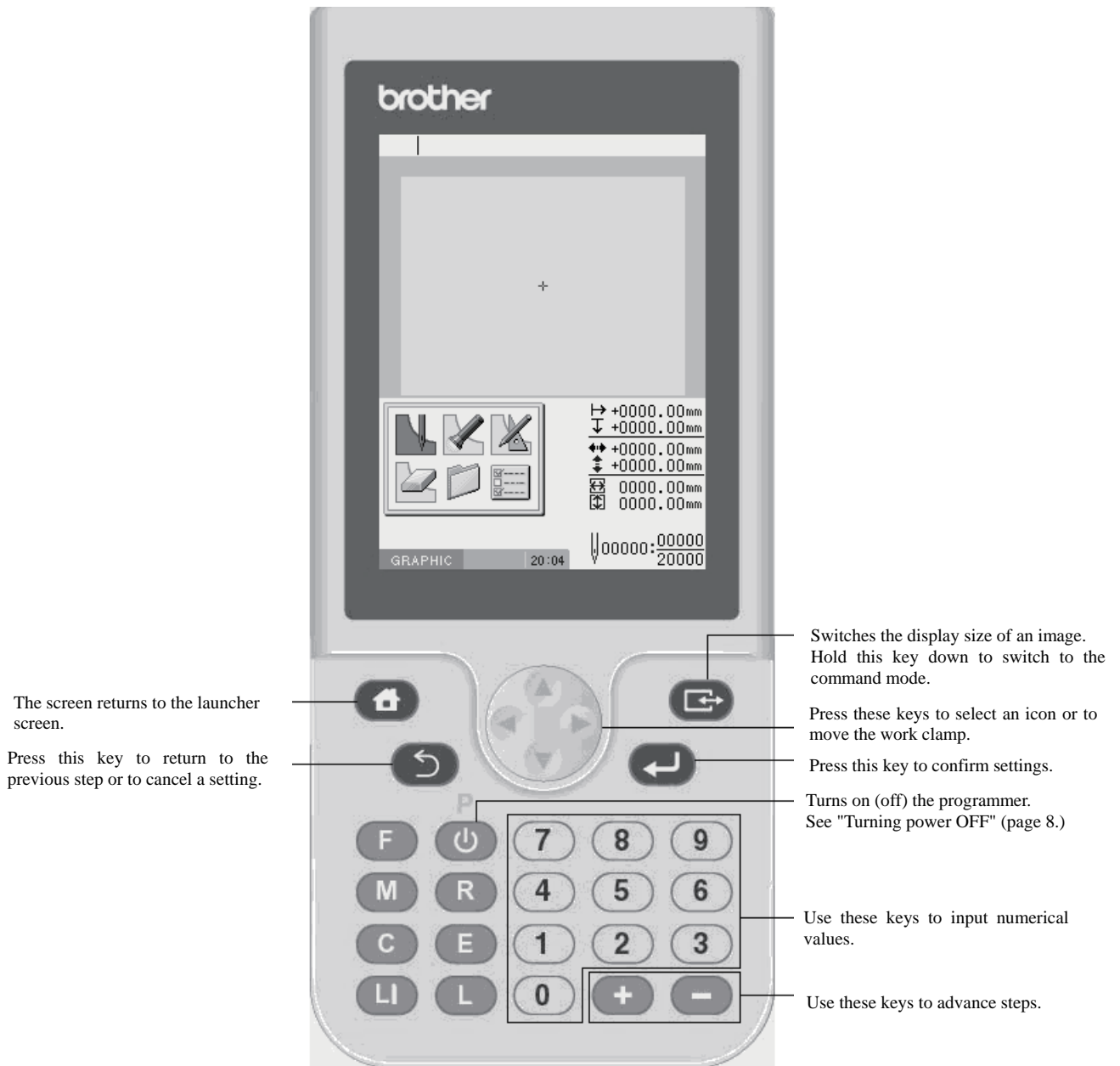

Making environment settings

Make environment settings of the programmer.

When you turn on the programmer for the first time, the initial setting screen appears. Make settings following the instructions on screen.



The following items can be set:

Smoothing equal pitch	Creates data so that the pitch becomes equal within the specified pitch range when the smoothing function is used
Area check	Does not create data outside the sewing area when program is being created or edited
Marker display	Displays a marker on the screen
JOG acceleration pattern	Changes the moving speed of a feed

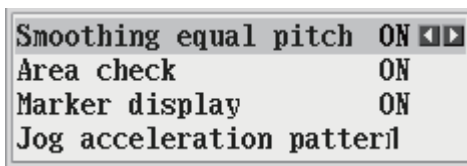
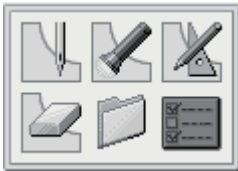

Select . Press .



Selecting the smoothing equal pitch and area check functions

1. Select an item by using .
2. Change the value by using .
3. After setting is complete, press .

Programming screen

On the launcher screen, select  and press  to display the programming screen. If the screen is not displayed, hold down .



* When the following message is displayed, press  to program without operating the sewing machine.

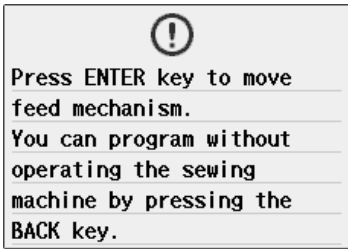

* When the following message is displayed, press  to program without operating the sewing machine.

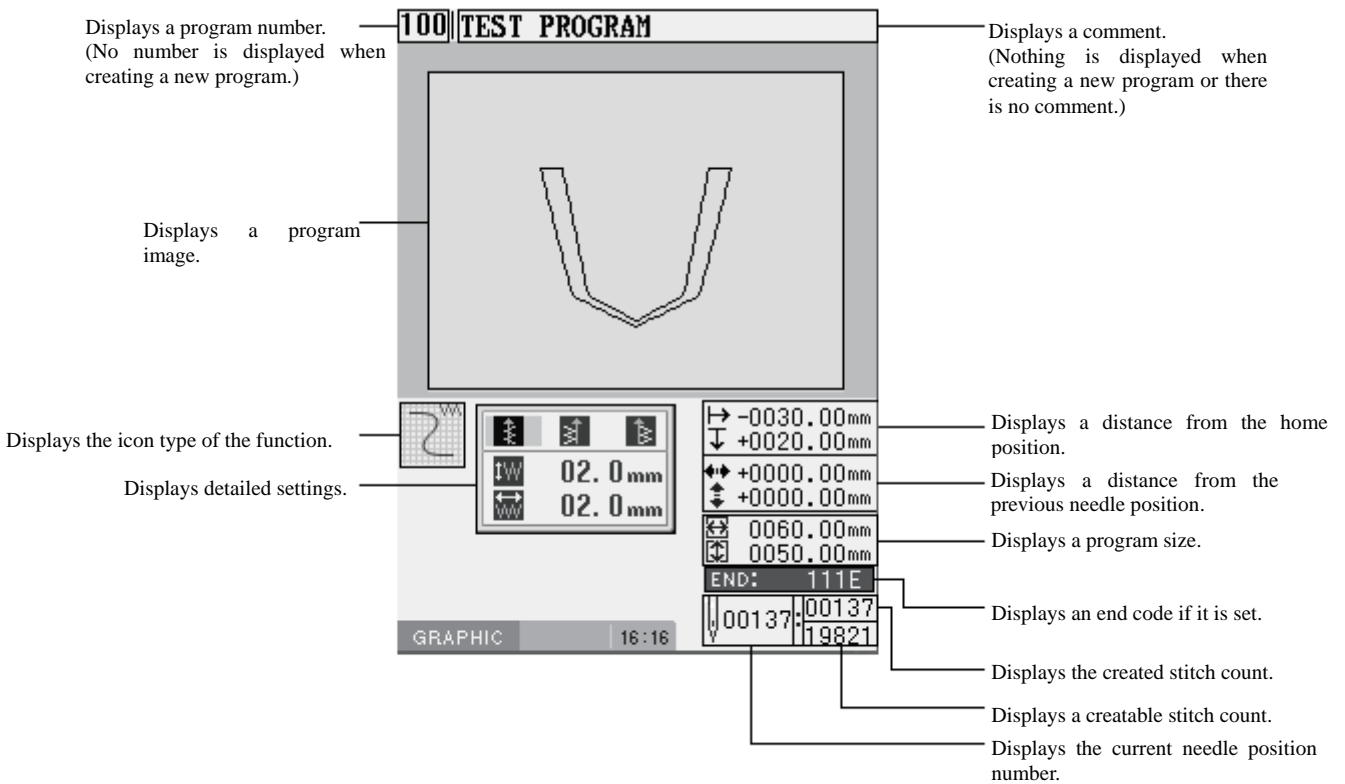
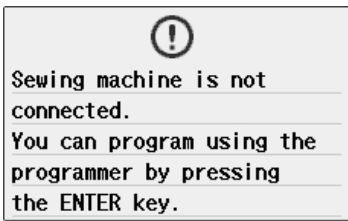

Description of icons



Programming



Specifying the sewing start point



Creating a line



Creating a curve



Creating a circle by specifying 3 points on the circumference



Creating a circle of the specified diameter (clockwise or counterclockwise)



Creating a circle of the specified radius (clockwise or counterclockwise)



Creating an arc



Creating a semicircle of the specified diameter (clockwise or counterclockwise)



Outline



Creating a zigzag stitch



Creating a zigzag circle by specifying 3 points on the circumference



Creating a zigzag circle of the specified diameter (clockwise or counterclockwise)



Creating a zigzag circle of the specified radius (clockwise or counterclockwise)



Creating double stitch data in the reverse direction of the sewing path



Creating double stitch data in the same direction as the sewing path



Offsetting



Creating a multiple stitch



Creating one stitch



Creating needle drop data



Creating feed data



Creating basting data



Creating trace data



Creating magnified data



Creating code



Setting the thread trimming code



Setting the option output code



Setting the low speed code



Setting the split speed code



Setting the basting code



Setting the height of presser foot



Setting a thread tension



Setting a trigger input



Inputting an end code



Checking the program setting and setting attribute



Editing the current program



Moving a pattern in parallel by feeding



Moving a pattern in parallel by sewing with the specified pitch



Moving in parallel



Moving a part of the pattern in parallel



Repeated copying a pattern



Copying a pattern symmetrically to the Y-axis



Copying a pattern symmetrically to the X-axis



Copying a pattern symmetrically to a point



Copying in the reverse direction



Deleting a part of the program



Creating a multiple stitch



Creating a stop stitch



Checking the program setting and setting attribute



Editing program



Moving a pattern in parallel



Moving a pattern symmetrically to the Y-axis



Moving a pattern symmetrically to the X-axis



Moving a pattern symmetrically to a point



Resizing a pattern



Copying a resized pattern



Resizing a pattern to the center point of data.



Copying a resized pattern to the center point of data.



Rotating a pattern (clockwise or counterclockwise)



Copying a rotated pattern (clockwise or counterclockwise)



Rotating a pattern to the center point of data (clockwise or counterclockwise)



Copying a rotated pattern to the center point of data (clockwise or counterclockwise)



Setting the extended option output



Deleting program



File



Reading program



Additional reading of program



Reading program in a different format



Writing program



Deleting a file



Formatting

Format

On the programming screen, the following five kinds of icons of media are displayed.



Flash memory of the programmer



CF card of the programmer



Flash memory of the sewing machine



CF card of the sewing machine



Floppy disk of the sewing machine (option)



Preference



Carries out the preference setting of the programmer.

- Smoothing equal pitch
- Area check
- Displaying marker
- Jogging movement acceleration pattern

Procedure for programming with icons

The procedure for programming with icons is as follows.

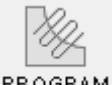
1. Displaying the programming screen

On the launcher screen, select  and press .

If the programming screen does not appear, hold down .

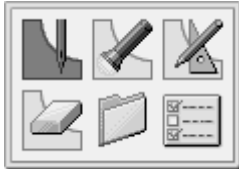



The work clamp moves to the home position and the programming screen is displayed.

2. Starting program creation

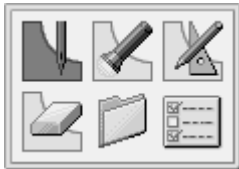
Select  with  and press .



3. Positioning the machine needle point at the first stitch of pattern sheet

Move the work clamp with . Press  when the needle point is at the first stitch of the pattern sheet.



The first stitch is programmed and the following screen appears.

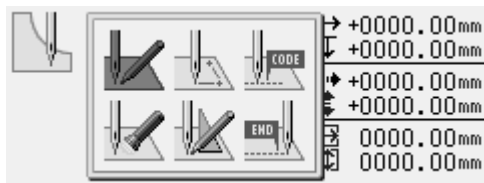

4. Creating program

Select an icon depending on your goal on the screen displayed in step 3 to create program for the pattern you want. The program is available until deletion. For details about program creations, refer to "Programming example" (page 32)/"Programming" (page 62).

■ 5. Inputting an end code

When programming is completed, input an end code to control the machine operation.

The following six end codes from 111 to 116 are available, each of which carries out machine operations as shown in the table below.

Program with no end code set is not available on the machine. A machine error occurs.



To prevent incomplete program from being used in error, you can make a conscious choice not to set any end code.

111	Normal end
112	Fixing the sewing speed at 1200 rpm or lower
113	Carrying out no thread wiping
114	Setting the sewing speed at 1200 rpm or lower without thread wiping
115	Carrying out no thread trimming
116	Fixing the sewing speed at 1500 rpm or lower

* 117 to 119 are not available.

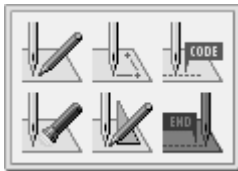
1. Select  with , and then press .



2. Select an end code type with , and then press .

"111" is selected in this example.



The work clamp returns to the first stitch.

3. Press .

The work clamp returns to the home position.

■ 6. Saving the created program

For more details about operations, refer to Chapter 6 "Saving program" (page 178).

1. Select  with , and then press .

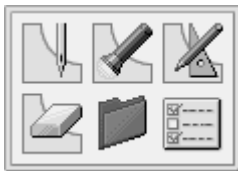

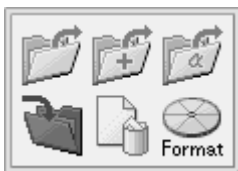

2. Select  with , and then press .



3. Input the program number, and then press .





4. Select characters with , and then press  to input comments.



5. Select "OK" with , and then press .



Note: To confirm the contents of the save destination, select , and then press .

■ 7. Ending programming

Press .

Programming example

This section describes the programming methods using specific examples.

Programming for each stitch: Page 32

Program a detailed pattern for each stitch (magnified input): Page 33

Pattern with lines: Page 33

Pattern with curves: Page 34

Double stitch: Page 35

Continuous sewing with the work clamp in position after thread trimming (feed): Page 36

Basting: Page 37

Symmetrical pattern: Page 38

Programming different patterns by splitting each in sequence (split): Page 39

Zigzag stitch: Page 40

Multiple stitch: Page 41

Programming tracing according to a pattern: Page 43

* For function and operating information about each icon, refer to "Programming" (page 62).

* In the programming example, point A in the illustration is the first stitch.

Programming for each stitch

The following describes how to perform programming for each stitch according to the pattern sheet.

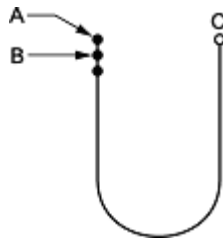

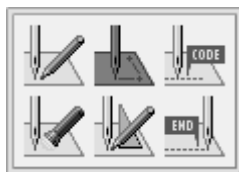

1. Carry out steps 1 to 3 of "Procedure for programming with icons".

2. Select  with  and press .



3. Select  with , and then press .



4. Move the work clamp with . Press  when the needle point is at point B of the pattern sheet.

5. Create the program to point C as in step 4.

6. When point C is programmed, press  twice.

7. Carry out steps 5 to 7 of "Procedure for programming with icons".

Programming a detailed pattern for each stitch (magnified input)

Use "magnified input" to accurately program a detailed pattern stitch by stitch. The following describes how to program the pattern below by magnifying it five times.

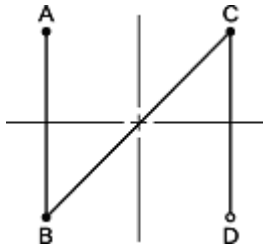

1. Carry out steps 1 to 3 of "Procedure for programming with icons".

2. Select  with $\Delta \nabla \triangleleft \triangleright$, and then press .

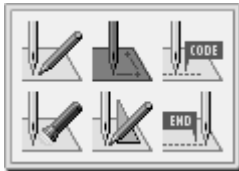

3. Select  with $\triangleleft \triangleright$, and then press .



4. Select $\times 5$ with $\triangleleft \triangleright$, and then press .



5. Move the work clamp with $\Delta \nabla \triangleleft \triangleright$. Press  when the needle point is at point B of the pattern sheet.

6. Create the program up to points C and D as in step 5.

7. When point D is programmed, press  three times.

8. Carry out steps 5 to 7 of "Procedure for programming with icons".

Pattern with lines

The following describes how to program a pattern with lines.

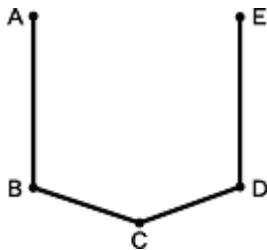

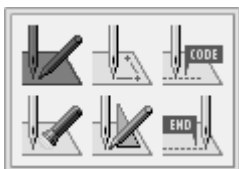

1. Carry out steps 1 to 3 of "Procedure for programming with icons".

2. Select  with $\Delta \nabla \triangleleft \triangleright$, and then press .

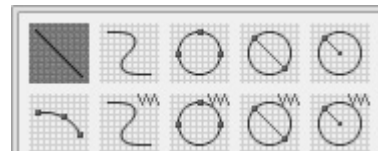

3. Select  with $\Delta \nabla \triangleleft \triangleright$, and then press .



4. Input the stitch length, and then press . Input "030" to make the stitch length 3.0 mm.

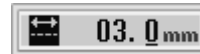

5. Move the work clamp with $\Delta \nabla \triangleleft \triangleright$. Press  when the needle point is at point B of the pattern sheet.

6. Create the program to points C, D and E as in step 5.

7. When point E is programmed, press  three times.

8. Carry out steps 5 to 7 of "Procedure for programming with icons".

Pattern with curves

The following describes how to program a pattern with curves.

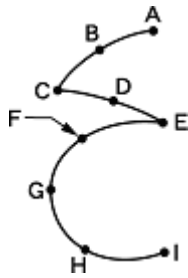

Be sure to press twice to make a split at corner points C or E. If a split is not made, the corner will be rounded.

When a split is made



When a split is not made



Making more intermediate points such as points B, D, F, G, and H creates smoother curves.

1. Carry out steps 1 to 3 of "Procedure for programming with icons".

2. Select with , and then press .

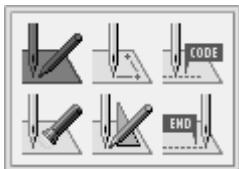

3. Select with , and then press .

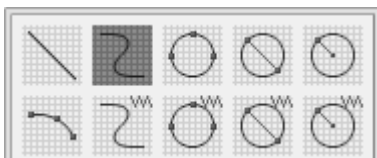

4. Input the stitch length, and then press .

Input "030" to make the stitch length 3.0 mm.

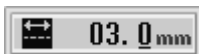

5. Move the work clamp with . Press when the needle point is at point B.

6. Program point C as in step 5.

7. When point C is programmed, press again for a split.

To change the stitch length, press to reset.

8. Create the program to point E.

9. When point E is programmed, press .

10. Create the program to point I.

11. When point I is programmed, press .

12. Press three times.

13. Carry out steps 5 to 7 of "Procedure for programming with icons".

Double stitch

Use “double stitch” to program two parallel lines. The following describes how to program the double stitch to the left of the sewing direction .

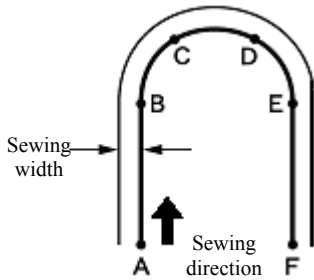

Be sure to press twice to make a split at a point B or E where the line changes to the curve. Placing more intermediate points such as points C and D creates smoother curves.

1. Carry out steps 1 to 3 of "Procedure for programming with icons".

2. Select with , and then press .

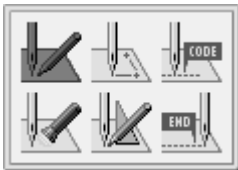

3. Select a double stitch type with , and then press .

In this example, select and press .

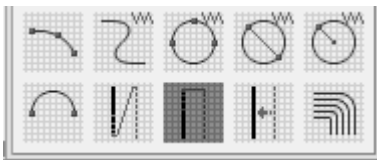

For double stitch types, refer to "Creating double stitch" (page 67).

4. Select where a double stitch is created, on the right or left of the sewing direction, with , and then press .

When creating it on the left side, select .



5. Input the stitch length and width, and then press .

Input "030" to make the stitch length 3.0 mm.

To switch input between the stitch length and the width, use .

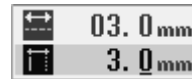

6. Move the work clamp with . Press twice for a split when the needle point is at point B of the pattern sheet.

7. Program points C, D and E.

8. When point E is programmed, press again for a split.

9. Program point F.

10. When point F is programmed, press .

11. Press .

The needle moves to points F, G and H.

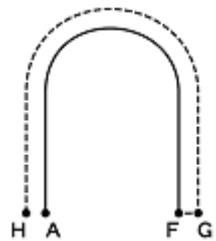

12. When the needle stops, press three times.

13. Carry out steps 5 to 7 of “Procedure for programming with icons”.



Continuous sewing with the work clamp in position after thread trimming (feed)

Set "feed" to continue sewing with the work clamp in position after thread trimming. The following describes how to program pattern 2 with a feed after pattern 1.



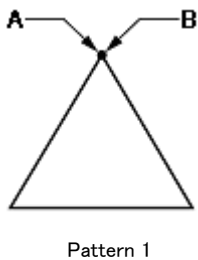

1. Program pattern 1.
⇒ Refer to "Pattern with lines" (page 32).



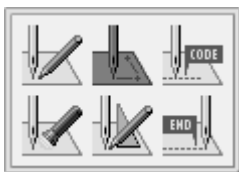

2. Press  three times after inputting point B.
The number of times  should be pressed depends on the programming method for pattern 1. When a linear line is programmed, press  three times. When each stitch is programmed, press it twice.

3. Select  with , and then press .





4. Select  with , and then press .

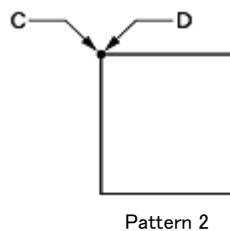

5. Move the work clamp with . Press  when the needle point is at point C of the pattern sheet.





6. Press  twice.
7. Program pattern 2.
⇒ Refer to "Pattern with lines" (page 33).
8. When point D is programmed, press  three times.
9. Carry out steps 5 to 7 of "Procedure for programming with icons".

Basting

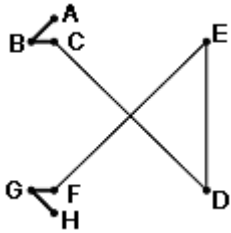
The following describes how to program basting from point C to point F.



1. Carry out steps 1 to 3 of "Procedure for programming with icons".

2. Select  with $\Delta \nabla \triangleleft \triangleright$, and then press .

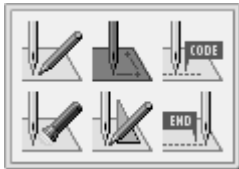

3. Select  with $\Delta \nabla \triangleleft \triangleright$, and then press .



4. Move the work clamp with $\Delta \nabla \triangleleft \triangleright$. Press  when the needle point is at point B.

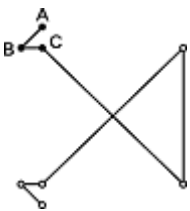

5. Program point C as in step 4.

6. When point C is programmed, press .

7. Select  with $\Delta \nabla \triangleleft \triangleright$, and then press .



8. Move the work clamp with $\Delta \nabla \triangleleft \triangleright$. Press  when the needle point is at D.

9. Program points E and F as in steps 8.

10. Press .

11. Select  with $\Delta \nabla \triangleleft \triangleright$, and then press .



12. Program points G and H.

13. When point H is programmed, press  twice.

14. Carry out steps 5 to 7 of "Procedure for programming with icons".

Symmetrical pattern

When programming a symmetrical pattern, program a target pattern and then select a symmetrical pattern type. The following describes how to program a pattern symmetrical to the Y-axis.

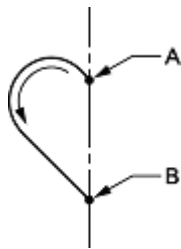

Symmetrical pattern type



Symmetrical to Y-axis

Select

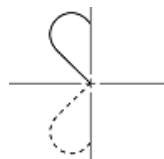

Symmetrical to X-axis

Select

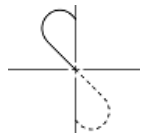

Symmetrical to point

Select

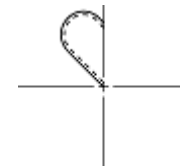

Turnover

Select

1. Create the program to point B.
⇒ Refer to "Programming for each stitch" (page 32) or "Pattern with curves" (page 34).

2. When point B is programmed, press three times.

The number of times should be pressed depends on the programming method.

3. Select with and then press .

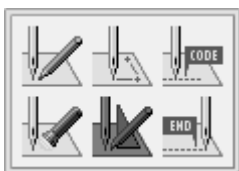

4. Select a symmetrical pattern type, and then press .

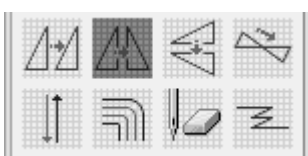

5. Input the number of feed boundaries to be ignored, and then press .



6. The needle point moves slowly from point B to point A in the right half and a symmetrical pattern is automatically programmed. Press to move the needle point faster.

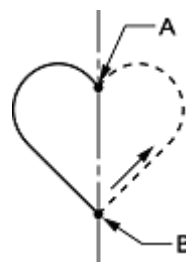

7. Press .
8. Carry out steps 5 to 7 of "Procedure for programming with icons".

Programming different patterns by splitting each in sequence (split)

Multiple patterns are programmed splitting each pattern in sequence. The following describes how to program 3 patterns in sequence.

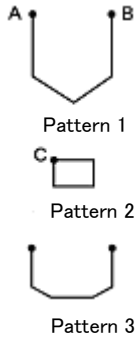

1. Program pattern 1.
⇒ Refer to "Pattern with lines" (page 33).
2. Press when the needle point is at point B of the pattern.

The number of times should be pressed depends on the programming method for pattern 1.

3. Select with and then press .

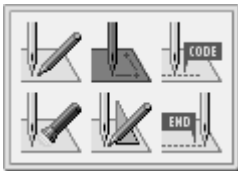

4. Select with and then press .



5. Move the work clamp with . Press when the needle point is at point C of the pattern sheet.

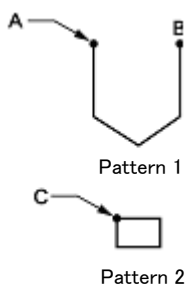

6. Press twice.

7. Select with and then press .

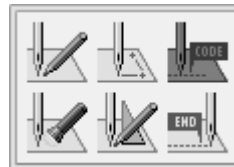

8. Select with and then press .

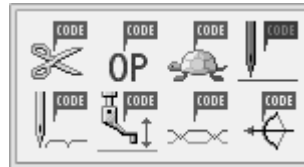

9. Select ON/OFF of needle stopping at the bottom with and then press .

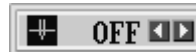

10. Press .
11. Program pattern 2.
⇒ Refer to "Pattern with lines" (page 33).
12. Program pattern 3 in the same way.
⇒ Refer to "Pattern with lines" (page 33).
13. When pattern 3 is programmed, press .
14. Carry out steps 5 to 7 of "Procedure for programming with icons".

Zigzag stitch

The following describes how to program zigzag stitch so that the sewing start point (A) is laterally centered.

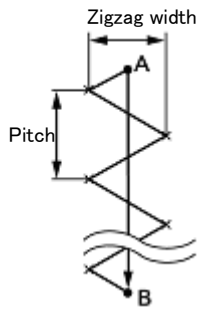

Zigzag with curves may be programmed.

1. Carry out steps 1 to 3 of "Procedure for programming with icons".

2. Select  with $\Delta \nabla \triangleleft \triangleright$, and then press \leftarrow .

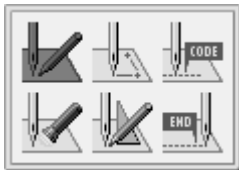

3. Select  with $\Delta \nabla \triangleleft \triangleright$, and then press \leftarrow .

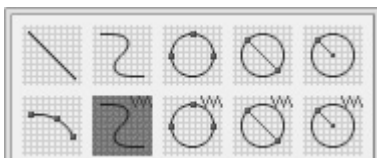

4. Select  with $\triangleleft \triangleright$, and then press ∇ .



5. Input the zigzag width and the stitch length, and then press \leftarrow .

Input "030" to make the stitch length 3.0 mm. To switch input between the stitch length and the width, use $\Delta \nabla$.

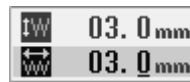

6. Move the work clamp with $\Delta \nabla \triangleleft \triangleright$. Press \leftarrow when the needle point is at point B of the pattern sheet.

To program curving zigzag, repeat this step.

7. Press \leftarrow again.
8. Press \rightarrow three times.
9. Carry out step 5 to 7 of "Procedure for programming with icons".

Multiple stitch

The following describes how to program multiple stitches.

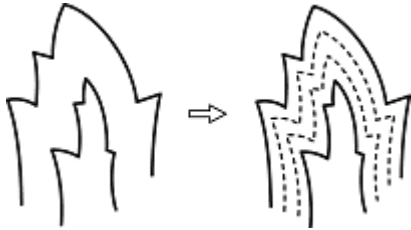

Programming is possible from a line at either the inside or the outside. Sewing is carried out in the order of programming and in the programmed direction.

When the sewing direction is changed at a sharp angle, provide a split in the vicinity of the direction change point for finishing the multiple stitch in relatively uniform conditions.

Up to 200 points can be specified for either the inside or the outside. If you attempt to input 201 or more points, the needle point is automatically returned to the previous point. In that case, start inputting the points of another side (outside or inside) line, or change the point input position or pattern.

■ Creating a stitch pattern

1. Create a pattern of the inner and outer lines for a multiple stitch.

The two lines should be spaced uniformly.

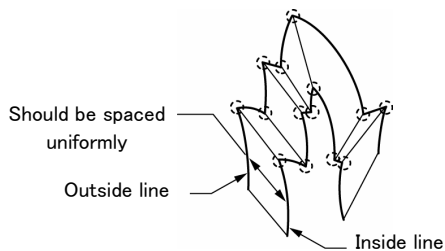

2. Connect each direction change point on the inside line with the matched direction change point on the outside line using a line.

3. Create at least 1 point between the direction change points on both the inner and outer lines, and connect the points in pairs on the inner and outer lines using a line.

Place these points in the same way as creating a curve.

⇒ Refer to "Pattern with curves" (page 34).

Specify direction change points in pairs on the inner and outer lines. The lines should be spaced uniformly.

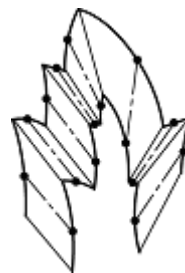

■ Programming

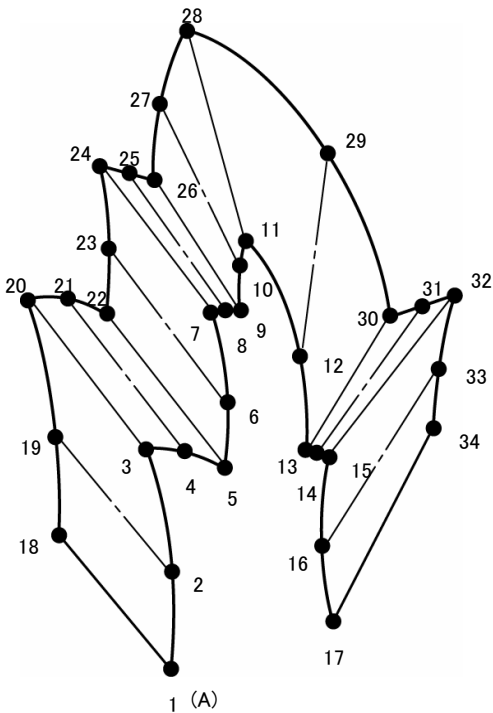

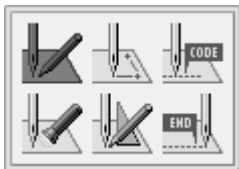

1. Carry out steps 1 to 3 of "Procedure for programming with icons".

2. Select  with $\Delta \nabla \triangleleft \triangleright$, and then press .



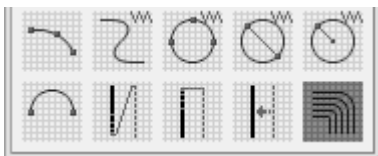

3. Select  with $\Delta \nabla \triangleleft \triangleright$, and then press .



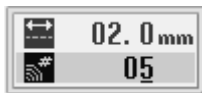

4. Input the stitch length and the number of lines for a multiple stitch. Press .

Input "020" to make the stitch length 2.0 mm.
Switch between the input fields of stitch length and the number of lines for a multiple stitch with $\Delta \nabla$.



5. Move the work clamp with $\Delta \nabla \triangleleft \triangleright$. Press  when the needle point is at point 2 of the pattern sheet.



6. Move the work clamp with $\Delta \nabla \triangleleft \triangleright$. Press  twice when the needle point is at point 3 of the pattern sheet.



Be sure to press  twice for a split at a corner at a sharp angle like point 3. If a split is not made, the corner will be round.



7. Program the following points up to point 17 with the curve programming steps.
⇒ Refer to "Pattern with curves" (page 34).



When programming a line, move the needle point from the line start point to the line end point, and press  twice.

In the example, a linear line is programmed between points 7 and 9. Be sure to program a linear line also for the matched section between points 24 and 26.

To return the needle point, follow the steps below.
Returning to the previous point: Press   (The needle cannot be returned beyond the previous split.)

Returning the previous split: Press   (When the needle position is at a split, it cannot be moved.)

Returning to the split before the previous one: Press  .

8. Press  and move the work clamp with $\Delta \nabla \triangleleft \triangleright$. Press  when the needle point is at point 18 of the pattern.

9. Program the following points up to point 34 in the same manner.

When programming, be sure that the points and splits specified on the inside line are paired with those on the outside line respectively.

If the points inside and outside are not paired, the needle point is automatically returned to the previous point. In such cases, perform programming again.

10. Press .

11. Press .



12. Carry out steps 5 to 7 of "Procedure for programming with icons".

Programming tracing according to a pattern

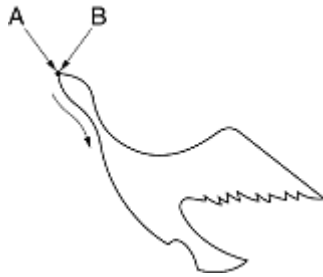

Carry out programming by using the numeric keys and $\Delta \nabla \triangleleft \triangleright$ so that the needle point accurately traces a pattern. The following describes how to carry out programming.

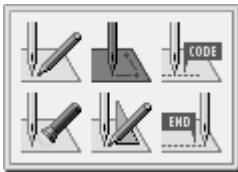

1. Carry out steps 1 to 3 of "Procedure for programming with icons".

2. Select  by using $\Delta \nabla \triangleleft \triangleright$. Press .



3. Select  by using $\triangleleft \triangleright$. Press .



4. Input a stitch length. Press .

To set the stitch length 3.0 mm, input "030".

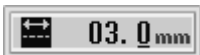

5. Operate the needle from the sewing start point A by using the $\Delta \nabla \triangleleft \triangleright$ so that its point accurately moves according to the pattern.

6. Press  when the needle point is at point B.

7. Press  three times.

8. Carry out steps 5 and 6 of "Procedure for programming with icons".





Note: At positions you want to sew with care (corners at a sharp angle or delicate parts), carry out programming by using . This will create a corner with clear stitches.

Procedure for modifying program



The procedure for modifying the program by using icons is as follows.

■ 1. Calling program to be modified

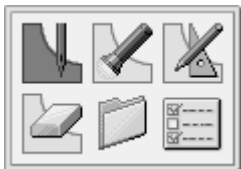
1. On the launcher screen, select  and press .
If the programming screen does not appear, hold down .



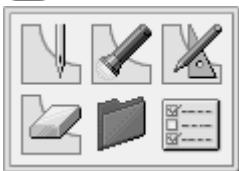

The work clamp moves to the home position and the programming screen is displayed.

2. Select  with , and then press .

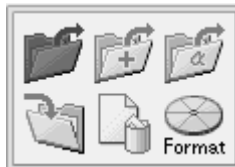

3. Confirm that  is selected. Press .



4. Input a program number to select by using the numeric keys. Press .

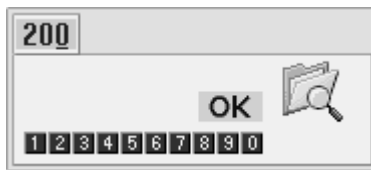

5. Select **OK**. Press .

To display the program list, select .



Refer to "Switching between media" (page 186).

■ 2. Starting program modification



Input an icon with  depending on your reason for modifying the program.
For details about program modification, refer to "Example of modified program" (page 46).

■ 3. Saving the modified program

For details about operations, refer to "Saving program" (page 178).

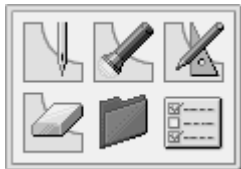
1. Select  with , and then press .





2. Select  with , and then press .



3. Input the program number, and then press .



4. Select characters with , and then press  to input comments.



5. Select "OK" with , and then press .



■ 5. Ending programming

Press .

Example of modified program

This section describes the program modification methods using specific examples.

Resizing a pattern: Page 46

Modifying a part of pattern: Page 47

Deleting the first stitch to change the sewing start point to the second stitch: Page 49

Moving the sewing start point: Page 50

Adding a new sewing start point before the first stitch: Page 51

Adding an escape point before the sewing start point: Page 52

Moving the escape point: Page 54

Deleting the escape point: Page 55

Moving the pattern in parallel (when the first stitch is the sewing start point): Page 56

Moving the pattern in parallel (when the first stitch is the escape point): Page 56

Deleting a part of data during programming: Page 58

Modifying a part of continuous program in parallel: Page 59

Modifying a part of continuous program in parallel: Page 60

Not breaking thread at the last stitch: Page 61

Resizing a pattern

The following describes how to resize a programmed pattern.

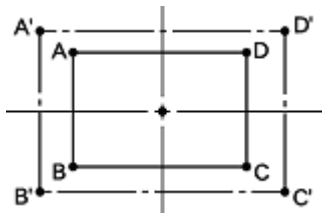

The reference point of resizing can be changed. The magnifying direction varies depending on the position of the reference point.

If the reference point is not determined, the pattern is resized on the basis of the home position.

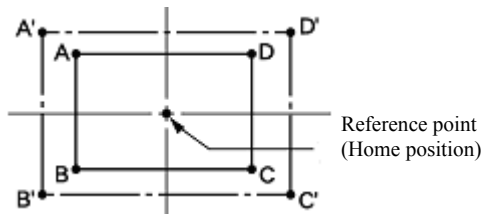

If the reference point is determined, the pattern is resized on the basis of the reference point.

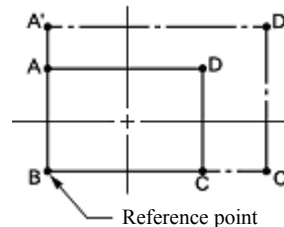

1. Carry out step 1 of "Procedure for modifying program".

2. Select  with $\Delta \nabla \triangleleft \triangleright$, and then press .



3. Select  with $\Delta \nabla \triangleleft \triangleright$, and then press .

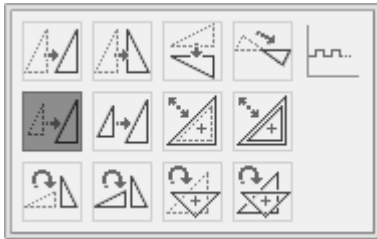

4. Input the resizing percentage for the X and the Y-axes.

To magnify the pattern by 150%, input 150.



5. Input the stitch length, and then press .

To resize the pattern keeping the number of stitches of the original data, input 0.0.



6. Move the needle to the reference point of resizing with $\Delta \nabla \triangleleft \triangleright$.

When resizing the pattern on the basis of the home position, there is no need to move the needle.

7. Press .

The pattern is resized.

8. Press .

9. Carry out steps 3 to 5 of "Procedure for modifying program".

Modifying a part of pattern

part of the programmed pattern is changed. The following describes how to modify 5, 6 and 7 to 5', 6' and 7'.

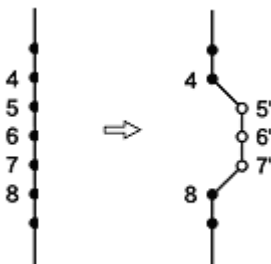

1. Carry out step 1 of "Procedure for modifying program".

2. Select  with $\Delta \nabla \triangleleft \triangleright$, and then press .

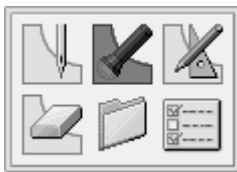

3. Press $9\ 9\ 9$, and then press .

The work clamp moves from the start point by each stitch.







4. When the needle point reaches 4, press .

The work clamp stops. When returning the needle point, input the number of stitches to be returned and press .

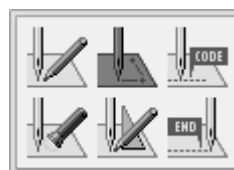



5. Press .

6. Select  with $\Delta \nabla \triangleleft \triangleright$, and then press .



7. Select  with , and then press .





8. Move the work clamp with   . Press  when the needle point is at 5'.

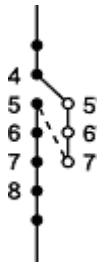

9. Program 6' and 7' as in step 8.

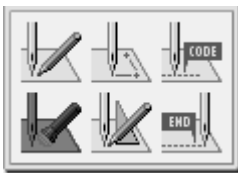

10. Press  twice.

11. Select  with   , and then press .



12. Press , and then press .

The needle point moves to 5.

13. Press .

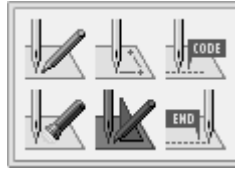

14. Select  with   , and then press .

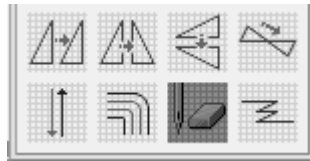

15. Select  with   , and then press .



16. Input the number of stitches to be deleted, and then press .

In the example, 3 stitches ahead are deleted. Press  .

The needle point moves to 6, 7 and 8. Points 5, 6 and 7 are deleted.

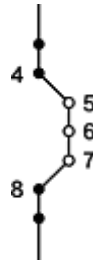

17. Press  three times.

18. Carry out steps 3 to 5 of "Procedure for modifying program".

Deleting the first stitch to change the sewing start point to the position of the second stitch

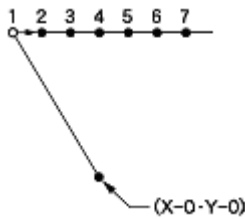

The following describes how to delete the sewing start point of a programmed pattern to make the second stitch as the sewing start point.

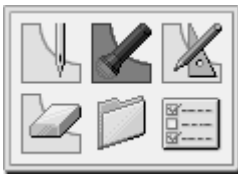

1. Carry out step 1 of "Procedure for modifying program".

2. Select  with $\Delta \nabla \triangleleft \triangleright$, and then press .



3. Press , and press .

The work clamp moves to the sewing start point.



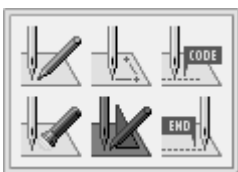

4. Press .

5. Select  with $\Delta \nabla \triangleleft \triangleright$, and then press .



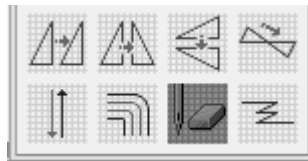

6. Select  with $\Delta \nabla \triangleleft \triangleright$, and then press .



7. Input the number of stitches to be deleted, and then press .

In the example, the white circle 1 is the first stitch.

The current machine needle is at the first stitch.

Press   and then the needle moves from the sewing start point to the second stitch position 2.

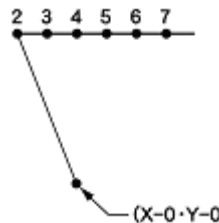

8. Press  three times.

9. Carry out steps 3 to 5 of "Procedure for modifying program".

Moving the sewing start point

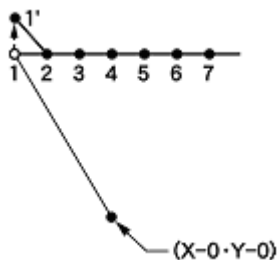

The following describes how to move the sewing start point from 1 to 1'.

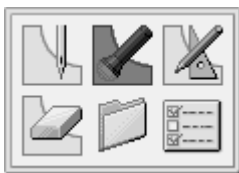

1. Carry out step 1 of "Procedure for modifying program".

2. Select  with $\Delta \nabla \triangleleft \triangleright$, and then press .



3. Press , and then press .

The work clamp moves to the sewing start point.

4. Press .

5. Select  with $\Delta \nabla \triangleleft \triangleright$, and then press .

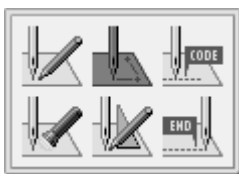

6. Select  with $\triangleleft \triangleright$, and then press .



7. Move the work clamp with $\Delta \nabla \triangleleft \triangleright$. Press  when the needle point is at point 1' of the pattern sheet.

1' is programmed.

8. Press  twice.

9. Select  with $\Delta \nabla \triangleleft \triangleright$, and then press .

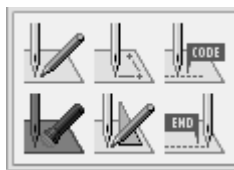

10. Press , and then press .

The work clamp moves to the sewing start point.

11. Press .

12. Select  with $\Delta \nabla \triangleleft \triangleright$, and then press .

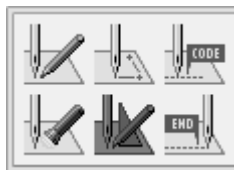

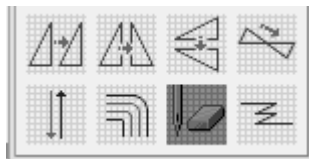

13. Select  with $\Delta \nabla \triangleleft \triangleright$, and then press .



14. Input the number of stitches to be deleted, and then press .

In the example, the white circle 1 is the first stitch.

The current machine needle is at the first stitch.

Press  , and then the needle moves from the sewing start point to 1'.

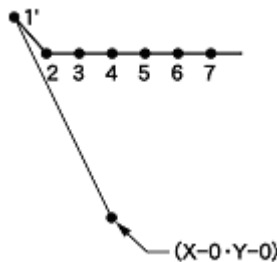

15. Press  three times.



16. Carry out steps 3 to 5 of "Procedure for modifying program".

Adding a new sewing start point before the first stitch

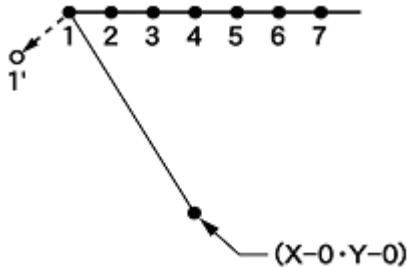
A point is added before the current sewing start point to make it as the sewing start point. The following describes how to change the sewing start point from 1 to 1'.



1. Carry out step 1 of "Procedure for modifying program".

2. Select  with , and then press .

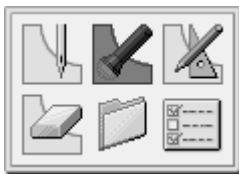

3. Press , and then press .

The work clamp moves to the sewing start point.

4. Press .

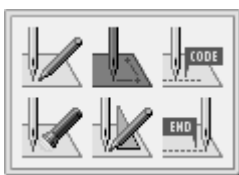

5. Select  with , and then press .



6. Select  with , and then press .



7. Move the work clamp with  so that the needle point is at 1' of the pattern.

Record the coordinates (values of X  and Y .

8. Press .



1' is programmed.

9. Move the work clamp with  an equivalent of the coordinates value recorded in step 5 in the opposite direction so that the needle point is at 1 of the pattern sheet.

10. Press .

1 is programmed again.

11. Press .

12. Select  with , and then press .

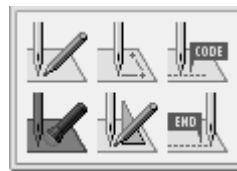

13. Press , and then press .

The work clamp moves to the sewing start point.

14. Press .

15. Select  with , and then press .

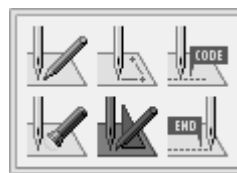

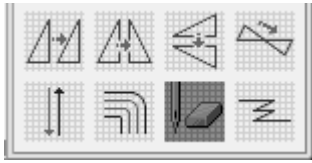

16. Select  with $\Delta \nabla \triangleleft \triangleright$, and then press .



17. Input the number of stitches to be deleted, and then press .

In the example, 1 is the first stitch.

The current machine needle is at the first stitch.

Press   and then the needle moves from the sewing start point to the white circle 1'.

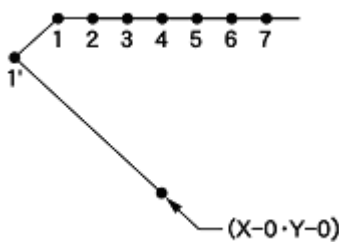

18. Press  three times.

19. Carry out steps 3 to 5 of "Procedure for modifying program".

Adding an escape point before the sewing start point

The following describes how to set the escape point A before the sewing start point.

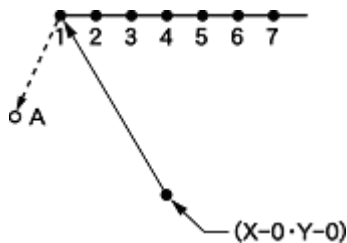

* The escape point is a provisional point provided to preventing the work clamp from interfering with the needle or the presser foot when the work clamp is lifted at the start point.

1. Carry out step 1 of "Procedure for modifying program".

2. Select  with $\Delta \nabla \triangleleft \triangleright$, and then press .

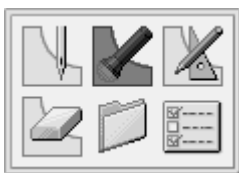

3. Press  , and then press .

The work clamp moves to the sewing start point.



4. Press .

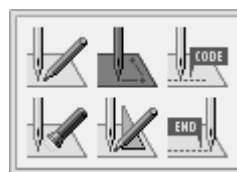

5. Select  with $\Delta \nabla \triangleleft \triangleright$, and then press .



6. Select  with , and then press .







7. Move the work clamp with    so that the needle point is at A of the pattern.

Record the coordinates (values of X  and Y .

8. Press .



A is programmed.

9. Move the work clamp with    an equivalent of the coordinate value recorded in step 5 in the opposite direction so that the needle point is at 1 of the pattern sheet.

10. Press .

1 is programmed again.

11. Press  twice.

12. Select  with , and then press .



13. Press , and then press .

The work clamp moves to the sewing start point.

14. Press .

15. Select  with , and then press .

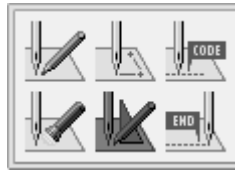

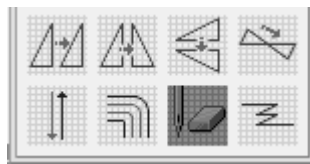

16. Select  with , and then press .



17. Input the number of stitches to be deleted, and then press .

In the example, 1 is the first stitch.

The current machine needle is at the first stitch.

Press   and then the needle moves from the sewing start point to the white circle A.

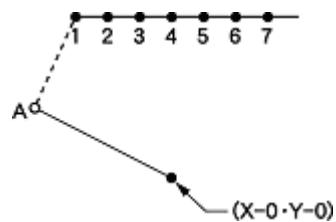

18. Press  three times.

19. Carry out steps 3 to 5 of "Procedure for modifying program".

Moving the escape point

The following describes how to move the escape point from A to B.

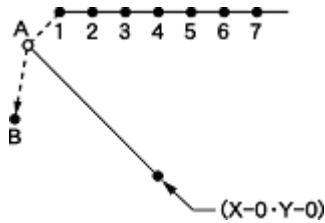

* The escape point is a provisional point provided to preventing the work clamp from interfering with the needle or the presser foot when the work clamp is lifted at the start point.

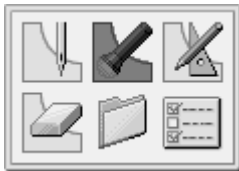

1. Carry out step 1 of "Procedure for modifying program".

2. Select  with $\Delta \nabla \triangleleft \triangleright$, and then press .



3. Press $\textcircled{1}$, and then press $\textcircled{+}$.
The work clamp moves to the escape point.

4. Press .

5. Select  with $\Delta \nabla \triangleleft \triangleright$, and then press .

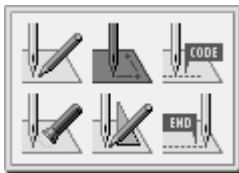



6. Select  with $\triangleleft \triangleright$ and press .



7. Move the work clamp with $\Delta \nabla \triangleleft \triangleright$. Press  when the needle point is at point B of the pattern sheet.

B is programmed.

8. Press  twice.

9. Select  with $\Delta \nabla \triangleleft \triangleright$, and then press .

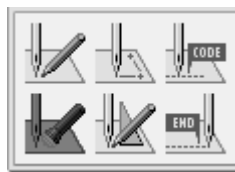

10. Press $\textcircled{1}$, and then press $\textcircled{-}$.

The work clamp moves to the sewing start point.

11. Press .

12. Select  with $\Delta \nabla \triangleleft \triangleright$, and then press .

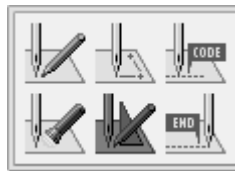

13. Select  with $\Delta \nabla \triangleleft \triangleright$, and then press .

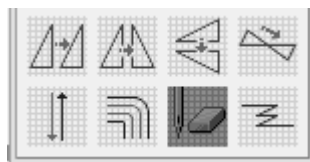

- Input the number of stitches to be deleted, and then press **+**.

In the example, 1 is the first stitch.

The current machine needle is at the first stitch.

Press **1** **+** and then the needle moves from the sewing start point to B.

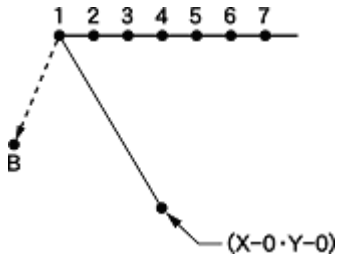

- Press **↶** three times.
- Carry out steps 3 to 5 of "Procedure for modifying program".

Deleting the escape point

The following describes how to delete the escape point A.

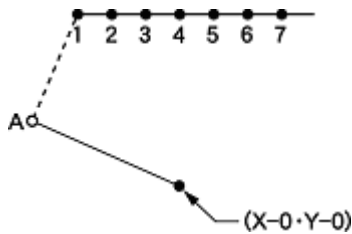

- Carry out step 1 of "Procedure for modifying program".

- Select  with **Δ▽◀▶**, and then press **↶**.

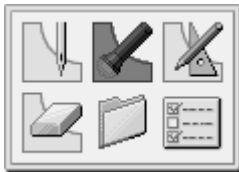

- Press **1**, and then press **+**.
The work clamp moves to the escape point.

- Press **↶**.

- Select  with **Δ▽◀▶**, and then press **↶**.

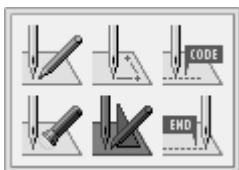

- Select  with **Δ▽◀▶**, and then press **↶**.

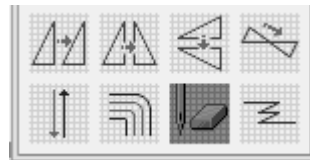

- Input the number of stitches to be deleted, and then press **+**.

In the example, 1 is the first stitch.

The current machine needle is at the first stitch.

Press **1** **+** and then the needle moves from the sewing start point to 1.

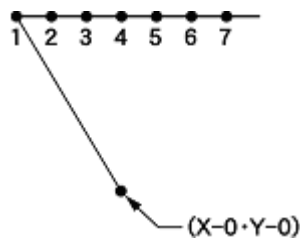

- Press **↶** three times.
- Carry out steps 3 to 5 of "Procedure for modifying program".

Moving the pattern in parallel (when the first stitch is the sewing start point)

The following describes how to move the pattern in parallel when the first stitch is the sewing start point.

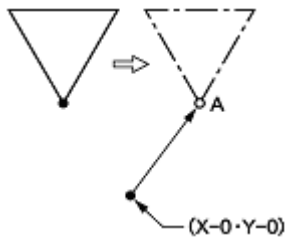



1. Carry out step 1 of "Procedure for modifying program".

2. Select  with $\Delta \nabla \triangleleft \triangleright$, and then press .

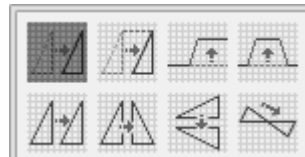

3. Select  with $\Delta \nabla \triangleleft \triangleright$, and then press .



4. Move the work clamp with $\Delta \nabla \triangleleft \triangleright$. Press  when the needle point is at point A of the pattern sheet.

5. Press .



6. Carry out steps 3 to 5 of "Procedure for modifying program".

Moving the pattern in parallel (when the first stitch is the escape point)

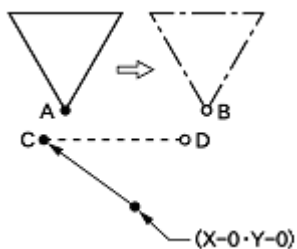
The following describes how to move the pattern in parallel when the first stitch is the escape point.



1. Carry out step 1 of "Procedure for modifying program".



2. Select  with $\Delta \nabla \triangleleft \triangleright$, and then press .





3. Press , and the press .

The work clamp moves to point A.

4. Press .

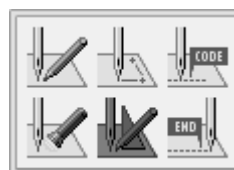
5. Select  with $\Delta \nabla \triangleleft \triangleright$, and then press .



6. Select  with $\Delta \nabla \triangleleft \triangleright$, and then press .

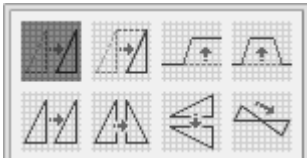

7. Move the work clamp with $\Delta \nabla \triangleleft \triangleright$ so that the needle point is at B of the pattern sheet.

Record the coordinates (values of X \leftrightarrow and Y \updownarrow). Do not press .

8. Press  three times.

The needle point returns to the home position.

9. Select  with $\Delta \nabla \triangleleft \triangleright$, and then press .

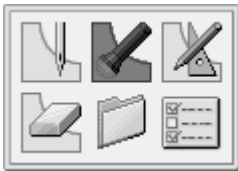

10. Press , and then press .

The work clamp moves to point C.

11. Press .

12. Select  with $\Delta \nabla \triangleleft \triangleright$, and then press .

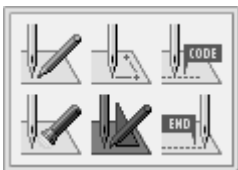

13. Select  with $\Delta \nabla \triangleleft \triangleright$, and then press .

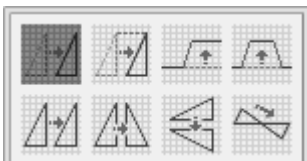

14. Move the work clamp with $\Delta \nabla \triangleleft \triangleright$ an equivalent of the coordinate value recorded in step 6.

15. Turn the pulley with a hand and put a marking with the needle to indicate the position of point D.

16. Turn the pulley with a hand and move the needle to the top point.

17. Press  three times.

18. Select  with $\Delta \nabla \triangleleft \triangleright$, and then press .

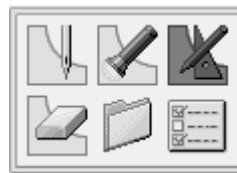

19. Select  with $\Delta \nabla \triangleleft \triangleright$, and then press .

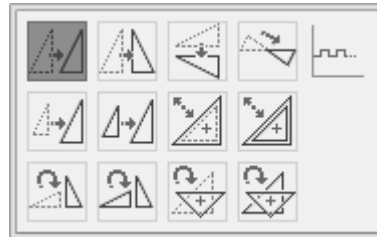

20. Move the work clamp with $\Delta \nabla \triangleleft \triangleright$. Press  when the needle point is at point D of the pattern.

21. Press .

22. Carry out steps 3 to 5 of "Procedure for modifying program".

Deleting a part of data during programming

The following describes how to delete 2 stitches (7 and 8) at point 8 and creating a new program.

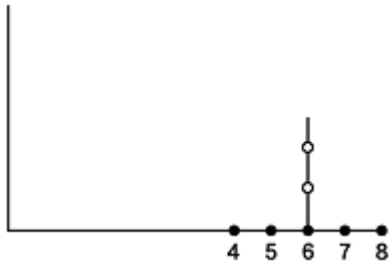

1. Press during programming to display the screen below.

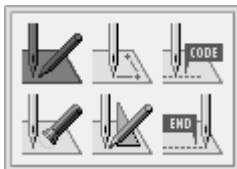

2. Select with , and then press .

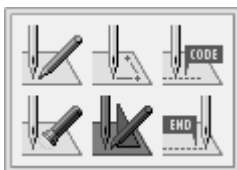

3. Select with , and then press .

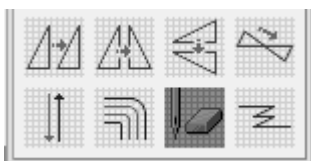

4. Input the number of stitches to be deleted, and then press .

In the example, the 2 previous stitches are deleted. Press .

The needle point moves to 6.

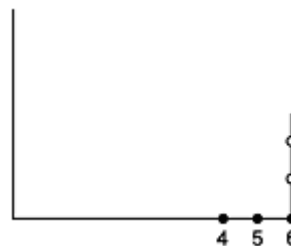

5. Press twice.
6. Continue programming.

Moving a part of a continuous program in parallel

The following describes how to move patterns B and C in parallel.

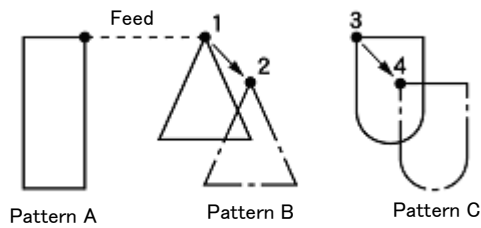

1. Select  with $\Delta \nabla \triangleleft \triangleright$, and then press .

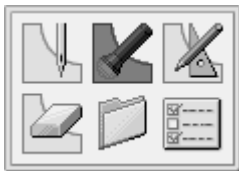

2. Press $9\ 9\ 9$, and then press .

The work clamp moves from the start point by each stitch.



3. When the needle point reaches 1, press .

The work clamp stops. When returning the needle point, input the number of stitches to be returned and press .

4. Press .

5. Select  with $\Delta \nabla \triangleleft \triangleright$, and then press .

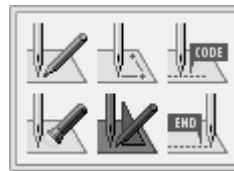

6. Select  with $\Delta \nabla \triangleleft \triangleright$, and then press .

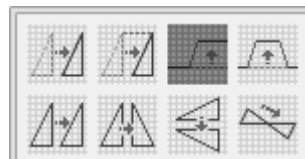

7. Move the work clamp with $\Delta \nabla \triangleleft \triangleright$. Press  when the needle point is at 2.

8. Move 3 to 4 as in steps 1 to 7.

Moving a part of a continuous program in parallel partially

Move a part of a continuous program in parallel to the position before the next feed is started. The following describes how to move only pattern B in parallel.

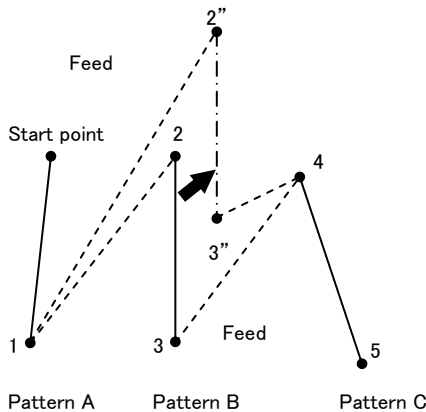

1. Select  with , and then press .

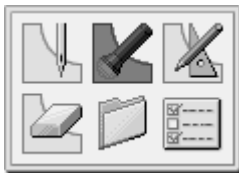

2. Press  and move to position 2.
The work clamp moves from the start point by each stitch.

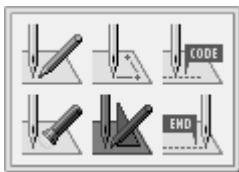

3. Press .

4. Select  with , and then press .

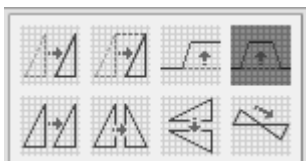

5. Select  with , and then press .



6. Move the work clamp with . Press  when the needle point is at 2.
7. Press  three times.

When the movement in parallel is carried out in the midst of the stitch data (6 between 2 and 3 in an example below), the movement in parallel reaches the start point of the next feed (position 3):

The movement in parallel reaches the start point of the next feed (position 3).

If the moving distance in parallel is 12.7 mm or less, the movement in parallel carried out in the stitch data and if the distance is more than 12.7 mm, the movement in parallel is done in the feed data.

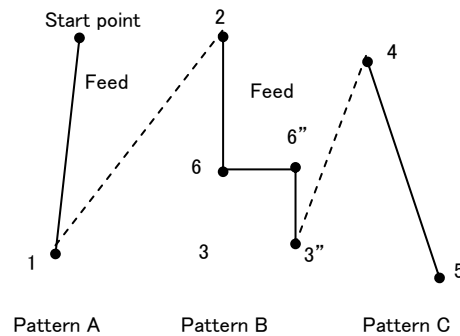

Not trimming thread at the last stitch

Deleting the thread trimming code after inputting the end code can cancel thread trimming at the last stitch.

* For not trimming thread at the last stitch, you can also set the end code to "115". In this case, every thread trimming including the emergency stop is canceled. Make the following setting for canceling thread trimming at the specified point.



■ Programming

1. Program a pattern.

■ Inputting an end code

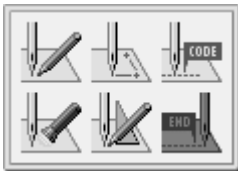
1. Select  with $\Delta \nabla \triangleleft \triangleright$, and then press .



2. Select the end code type with , and then press .
⇒ Refer to "Procedure for programming with icons" (page 29).





"111" is selected in the example. Press  and the work clamp returns to the first stitch (point A).



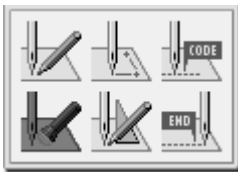

■ Deleting the thread trimming code



1. Select  with $\Delta \nabla \triangleleft \triangleright$, and then press .





2. Press    , and then, press .

The work clamp moves to the last stitch.

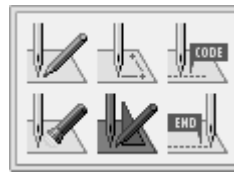

3. Press  .
4. Press .

5. Select  by using $\Delta \nabla \triangleleft \triangleright$. Press .

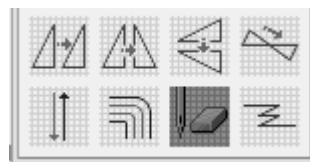

6. Select  by using $\Delta \nabla \triangleleft \triangleright$. Press .



7. Press   to delete the thread trimming code.





This section describes icons used for creating and editing program and how to use them.



* For details about operations, refer to "Programming example" (page 32).

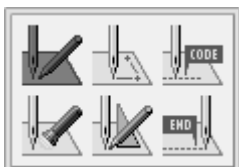

Creating a line

1. Select , and then press .



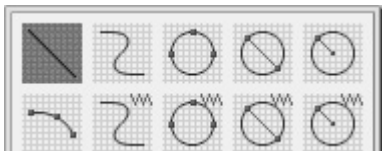

2. Select , and then press .

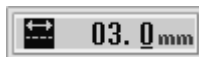

3. Input the stitch length, and then press .





4. Move the needle to the next point with . Press .





Creating a curve

Increase the number of plotting points to create a smoother curve. One to 99 points are available for plotting.

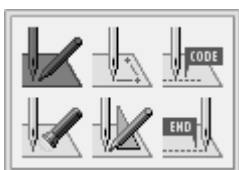
1. Select , and then press .



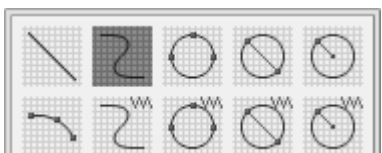

2. Select , and then press .

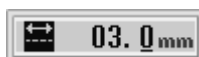

3. Input the stitch length, and then press .



4. Move the needle with . Press .

5. Repeat step 4 until a desired pattern is created. When the needle point reaches the end point, press  twice.



Check that both values are 0000.00 mm.

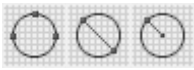

Creating a circle

The following three options are available for creating a circle.



Creating a circle by specifying 3 points on the circumference





Specify a diameter to create a circle (clockwise or counterclockwise)



Specify a radius to create a circle (clockwise or counterclockwise)

■ If is selected

1. Select , and then press .

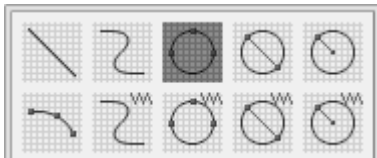





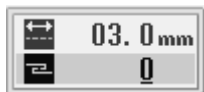

2. Input the stitch length and the overlap stitch count, and then press .

Values of 0 to 9 are available for input.





————— Stitch length
 ————— Stitch count for overlap sewing

3. Move the needle to the second point with   . Press .

4. Move the needle to the third point with . Press .



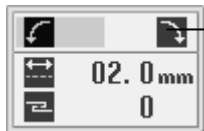

■ If is selected

1. Select the sewing path of the needle   and input the overlap stitch count, then press .

Values of 0 to 9 are available for input.





————— The sewing path of the needle
 ————— Stitch length
 ————— Stitch count for overlap sewing

2. Move the needle to a point you want to set as a diameter or radius with   . Press .







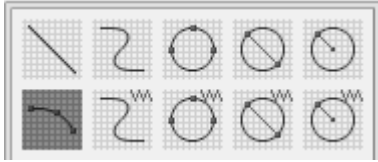





Creating an arc

1. Select , and then press .



2. Input the stitch length, and then press .



3. Move the needle to the second point with    . Press .
4. Move the needle to the third point with    . Press .



Creating a semicircle



The following two options are available for creating a semicircle.





Specifying a diameter to creating a clockwise semicircle



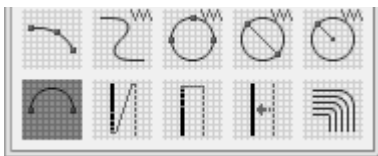

Specifying a diameter to create counterclockwise semicircle

1. Select , and then press .

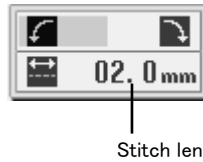

2. Select the method of creating a semicircle and input the stitch length. Press .



3. Move the needle to the end point with    . Press .



Creating a zigzag stitch

The following three options are available for creating a zigzag stitch.



Creating a zigzag stitch so that the created curve comes to the center of the width of the zigzag



Creating a zigzag stitch so that the created curve comes to the right extremity of the width of the zigzag



Creating a zigzag stitch so that the created curve comes to the left extremity of the width of the zigzag

One to 99 points are available for plotting.

1. Select , and then press

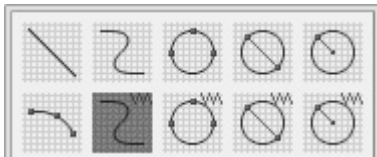

2. Input a zigzag type and input a zigzag stitch width and length, and then press



3. Move the needle to the second stitch with . Press
4. Repeat step 3 to a desired point. When the needle point reaches the end point, press twice.



Check that both values are 0000.00 mm.



Creating a zigzag circle

The following three options are available for creating a zigzag circle.



Specifying 3 points on the circumference to create a zigzag circle



Specifying a diameter to create a zigzag circle (clockwise or counterclockwise)



Specifying a radius to create a zigzag circle (clockwise or counterclockwise)

- If is selected

1. Select , and then press

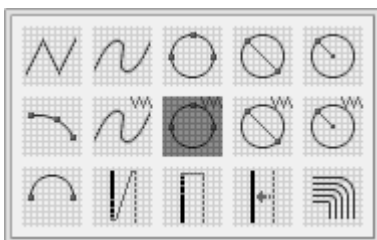

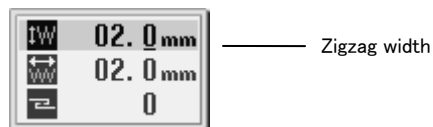

2. Input the zigzag stitch width, stitch length and the overlap stitch count, and then press

Values of 0 to 9 are available for input.



3. Move the needle to the second point with . Press
4. Move the needle to the third point with . Press





■ If  is selected

1. Select the sewing path of the needle  , input a zigzag stitch width, stitch length and the overlap stitch count, and then press .

Values of 0 to 9 are available for input.



- The sewing path of the needle
- Zigzag width
- Zigzag pitch
- Stitch count for overlap sewing

2. Move the needle to a point you want to set as a diameter or radius with    . Press .

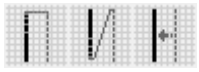

Creating double stitch

The following three options are available for creating a double stitch.



Creating double stitch data in the reverse direction to the left side of the sewing path or the right side .



Creating double stitch data in the same direction to the left side of the sewing path or the right side .



Carrying out offset to the left side of the sewing path or the right side .

* If sharp angles or fine curves are included, the desired double stitch may not be achieved.

1. Select and then press .

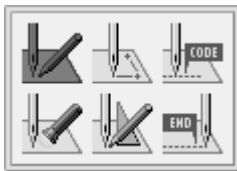

2. Select the type of double stitch, and then press .

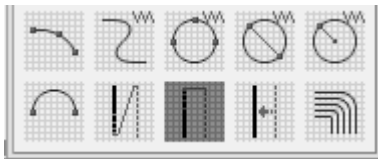

3. Select a position where a double stitch is created, input the stitch length and the double stitch width, and then press .



Position where a double stitch is created
 Stitch length
 Double stitch width

4. Move the needle to the next point with . Press .
 Press twice to change the direction of sewing.

5. Repeat step 4 until the needle reaches the end point and press three times.

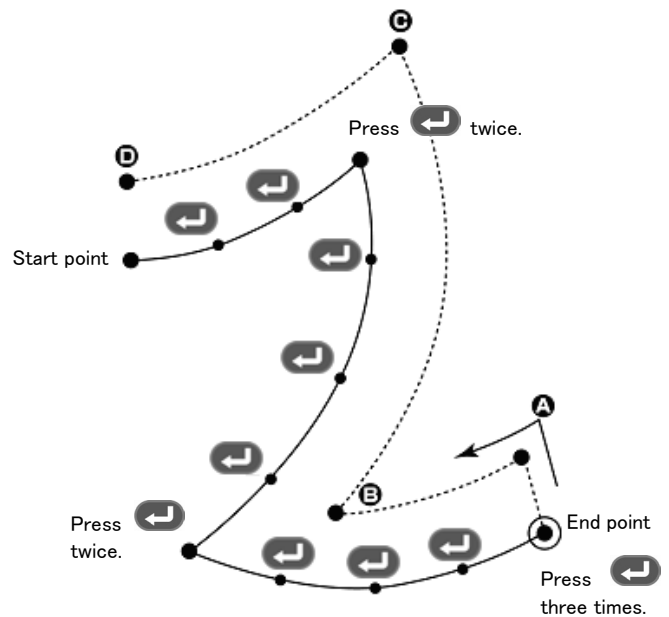

Press twice. Calculation starts. After the calculation, press again.

Calculation for double stitches start again. When the calculation stops, the needle moves in the order of A, B, C and D. The program is completed when the needle comes to D.





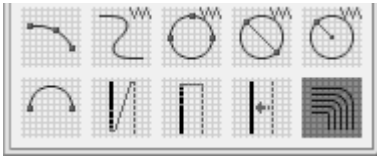

Creating a multiple stitch

1. Select , and then press .



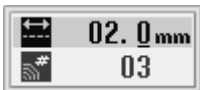

2. Input the stitch length and the number of lines for a multiple stitch, and then press .



Move the needle to the next point with . Press .

When changing the embroidering direction, provide a split by pressing  twice.

Press  and move the needle point from the inside line to the outside line (or vice versa).  becomes valid after input of a split.

When programming, be sure that the points and splits specified on the inside line are paired with those on the outside line respectively.

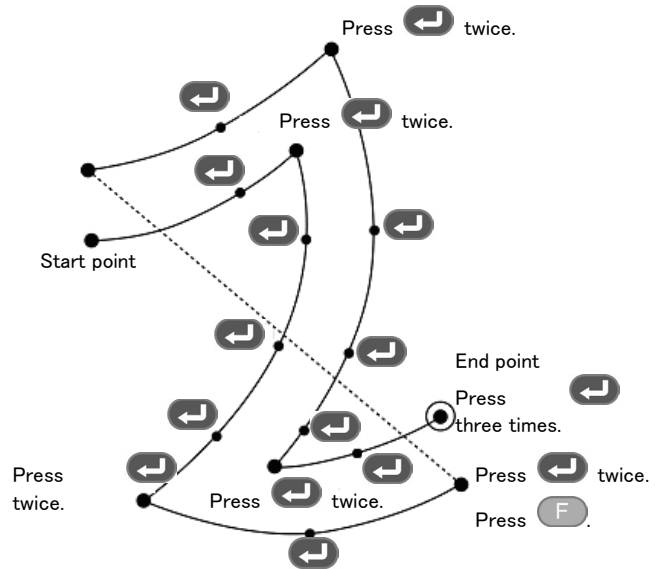

3. Repeat step 3 until the needle reaches the end point and press  three times.

Calculation starts based on the input data. On completion of the calculation, programming is complete.





Creating needle drop data

Create needle drop data for the current needle position.

1. Select  and press .





2. Move the needle to a point of which data you want to set as needle drop data with . Press .





Creating feed data

Create (feed) data to move the needle to the next position without needle drop at the current position.

1. Select  and then press .





2. Move the needle to a point you want use as feed data with . Press .





Creating basting data

Create basting data.

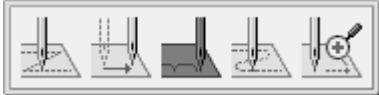
1. Select , and then press .





2. Move the needle to the next point with . Press .



Creating trace data

Carry out programming by operating numerical keys and  so that the needle point accurately traces a pattern.

1. Select , and then press .



3. Start operating the needle at the sewing start point using the  so that the needle point accurately traces the pattern.

2. Input the stitch length, and then press .

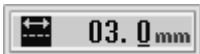



4. Press  when the needle point reaches the sewing end point.





Checking the program setting and setting attributes

Refer to "Checking the program setting and setting attributes" (page 78).

■ If  is selected

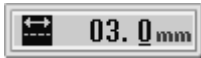



1. Input the stitch length, and then press .



2. Adjust the destination with , and then press .

■ If   is selected

Adjust the destination with , and then press .

■ If      is selected

Data separated with feed data are partially copied.

If the number of feed boundaries to be ignored is 0:

Only data unit C is copied.

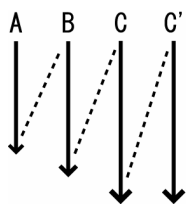

If the number of feed boundaries to be ignored is 1:

Data unit B and C are copied.

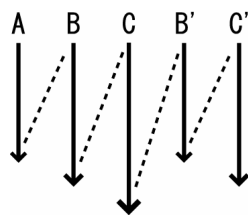

If the number of feed boundaries to be ignored is 2:

Data unit A, B and C are copied.

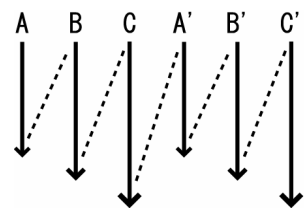

1. Input the number of feed boundaries to be neglected.

To ignore all feed, input 99.

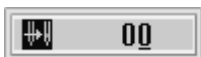

2. Press .



■  **Modifying the stitch length or the number or lines for a multiple stitch**

When modifying the stitch length or the number of lines for a multiple stitch, the previously created curve program can be used.

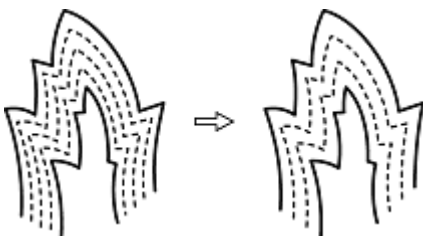



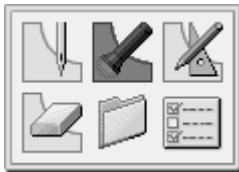

* Programs created previously are required for modifying programs of multiple stitches.

* Data for a multiple stitch saved in media cannot be modified.

1. Select  with $\Delta \nabla \triangleleft \triangleright$, and then press .





2. Press   , and then press .

The work clamp moves from the start point by each stitch.





The work clamp moves. When the needle point is at the start point for a multiple stitch, stop it by pressing .

3. Press .

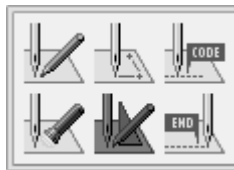
4. Select , and then press .



5. Select , and then press .

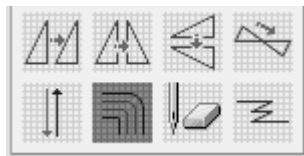

6. Input the stitch length and the number of lines, and then press .

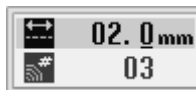



Calculation is performed based on the input data. When the calculation ends, the needle point moves to the end point for a multiple stitch.



Deleting a part of current data

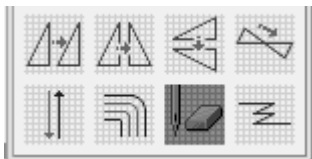

Preadjust the needle position to the first or last point of a part to be deleted. Refer to "Checking the program setting and setting attribute" (page 78).

1. Select , and then press .



2. Input the stitch count to delete.





3. Press  to delete data following the current needle position for the input count. Press  to delete data prior to the current needle position.

The corresponding data is deleted.



Creating a stop stitch

Create stop stitch data.

1. Select , and then press .

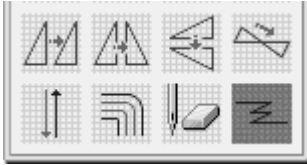

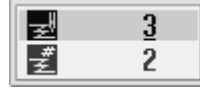

2. Input a stop stitch count and stop stitch creation count. Press .





For example, input 3 for the stop stitch count and 2 for the stop stitch creation count. Then, data for 3 stitches backward from the current needle position and without a break, data for 3 stitches forward are created. With this, two stop stitch creations are completed.

 **Making out thread trimming**

You can specify whether to make thread trimming or not.

1. Select , and then press .





2. Use  to specify whether to make thread trimming or not, then press .

 **OP Setting out option output**

Flipping/flopping option output is possible.

1. Select , and then press .



2. Select option output to flip/flop with , and then press .

ON: The option output is flipped/flopped.
 OFF: The option output is not flipped/flopped.

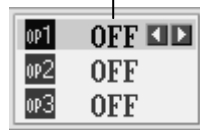



 **Low-speed sewing**

By setting low-speed sewing, you can reduce sewing speed.
 The following five low-speed sewing settings are available.

0 (Low-speed 0)	Sewing speed is not reduced. (Used for canceling other options.)
1 (Low-speed 1)	The maximum sewing speed is set at 1200 rpm or lower.
2 (Low-speed 2)	The maximum sewing speed is set at 800 rpm or lower.
3 (Low-speed 3)	The maximum sewing speed is set at 600 rpm or lower.
4 (Low-speed 4)	The maximum sewing speed is set at 400 rpm or lower.

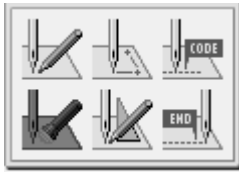
1. Adjust the needle position with  to the first point of a part for which low-speed sewing is set.



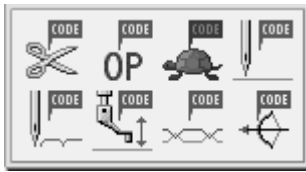

2. Select  , and then press .



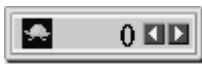

3. Select an option of low-speed sewing with .

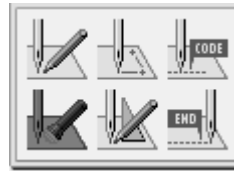

4. Press .
5. Press .
6. Adjust the needle position with  to a point at which setting of low-speed sewing is canceled.



7. Press .
8. Select a low-speed sewing code as in step 2, and then press .

9. Select Low-speed 0 with .





10. Press .

Creating split data

Specify breakpoints for sewing a series of different patterns.
For details, refer to "Programming different patterns by splitting each in sequence" (page 39).

1. Select  , and then press .



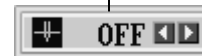

2. Use  to specify whether to stop the needle at the lower end or not, and then press .

ON: The needle stops at the lower end.
Thread breakage is not carried out.
OFF: The needle stops at the upper end.
Thread breakage is carried out.





Basting

Basting can be input.

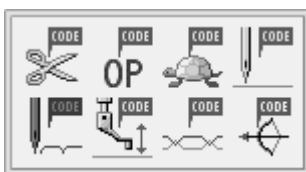
1. Select  , and then press .





2. Use  to select ON/OFF, and then press .



Changing the height of the presser foot

The height of the presser foot is changed. Height values of -10.0 to 10.0 are available for input. Inputting 00 cancels the setting for the height of the presser foot.

1. Select , and then press .



2. Press the height of the presser foot, and then press .

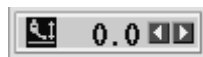

Changing the thread tension

The thread tension can be changed. Thread tension levels 0 to 9 are available for input.

1. Select , and then press .

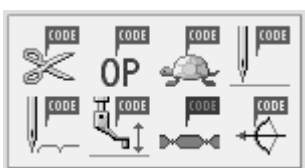

2. Input a thread tension level, and then press .

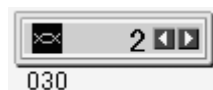



Displays the setting value of the sewing machine when the sewing machine is connected.





Inputting the trigger

Input the trigger for the extended option output. Adjust the needle position before inputting the trigger and setting attribute. Refer to "Checking the program setting and setting attribute" (page 78).

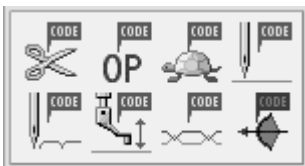
1. Select , and then press .



3. Move the cursor with , then use  to specify whether to stop the machine or not.



2. Input the number of option output.

For the number of option output, refer to "Extended option output" (page 74).

ON: The needle stops at the upper end without thread breakage, and restarts after output of the extended option.
OFF: Sewing does not stop.



Ending programming

When programming is completed, input an end code.
The following six end codes are available.

111 Normal end



112 Fixing the sewing speed at 1200 rpm or lower

113 Making no thread wiping

114 Setting the sewing speed at 1200 rpm or lower without thread wiping

115 Making no thread trimming

116 Fixing the sewing speed at 1500 rpm or lower

1. Select , and then press .

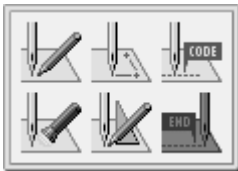

2. Select a code with , and then press .

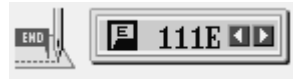

Checking the program setting and setting attributes

It is possible to check the program setting and setting attributes.
The following items are displayed.

Data type

- Stitch
- Feed
- Thread trimming
- Basting
- * Option output
- * Low-speed
- * Splitting
- * Height of presser foot
- * Thread tension
- * Trigger

100 | TEST PROGRAM

000
F + -

OP1	OFF
OP2	ON
OP3	OFF

↑	+0000.00mm
↓	-0030.00mm
↕	-0001.65mm
↕	-0000.85mm
⊠	0060.00mm
⊠	0050.00mm
END:	111E
↓	00036: 00139
	19821

Inputs the stitch count to confirm.

Displays details of data.

Regarding data type items marked with *, you can set their attributes.

Select or and press .

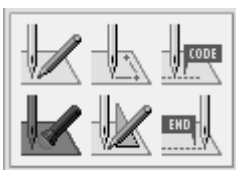
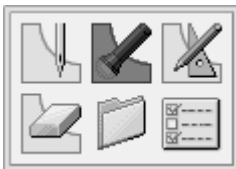

Checking each stitch

Press **+** to move forward, and press **-** to move backward.

The needle steps by each stitch and the data settings are displayed.

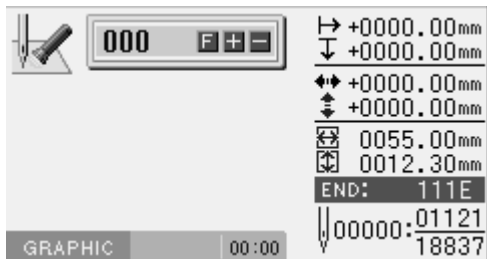

Checking a series of stitches automatically

1. Input the stitch count to move.



2. Press **+** to move the needle forward, and press **-** to move it backward.

The needle moves according to the input count, and the setting of the data is displayed.

Input "999" to check all stitches.

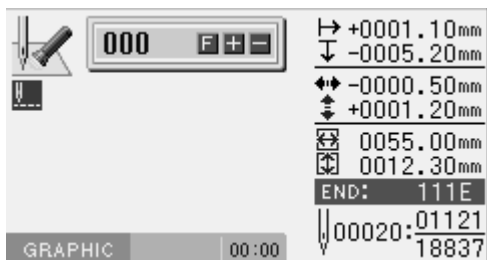

Skipping

1. Input the stitch count to the destination.
2. Press **F**, and then press **+** to move the needle forward and **-** to move it backward.

The needle skips sewing according to the input stitch count.

Input "999" to skip sewing to the sewing end point or to a breakpoint.

■ **Setting the attribute**

1. Move the needle to the position you want to apply the command at, and then press .

The attribute setting screen appears.

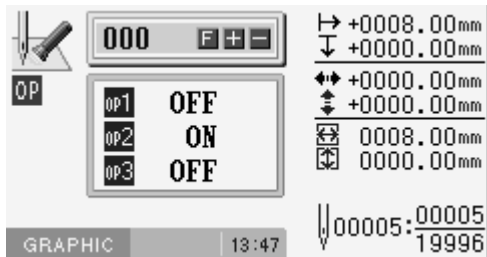

2. Set the attribute. (Example: option output)

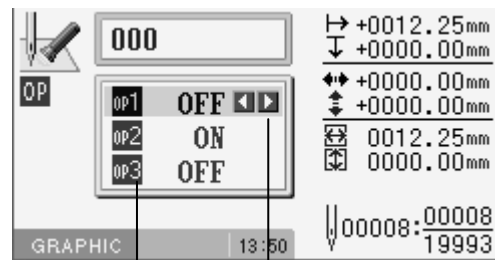

3. Press  after setting.

The screen returns to the confirmation screen.



Editing program

Edit the retrieved or created program.

The following options are available as editing functions.



Moving a pattern in parallel (Changes the sewing start point.)



Moving a pattern symmetrically to the Y-axis



Moving a pattern symmetrically to the X-axis



Moving a pattern symmetrically to a point



Resizing a pattern



Copying a resized pattern



Resizing a pattern to the center point of data



Copying a resized pattern to the center point of data



Rotating a pattern (clockwise or counterclockwise)





Copying a rotated pattern (clockwise or counterclockwise)



Moving a pattern to the center point of data (clockwise or counterclockwise)





Copying a rotated pattern to the center point of data (clockwise or counterclockwise)



1. Select , and then press .

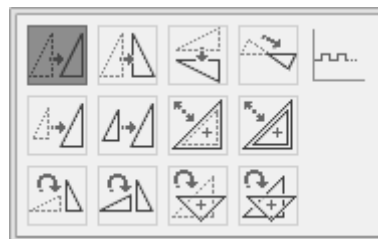

2. Select an editing function, and then press .



If  is selected

1. Adjust movement in the X/Y direction with .
2. Press .

If  is selected

1. Press .

The pattern is moved symmetrically on the basis of the sewing start point.

If  is selected

1. Input a resizing scale in the X and Y directions and stitch length.

Resizing scale between 0 and 400% are available.

If the stitch length is 0.0, the pattern is resized with the same number of stitches as the original data.

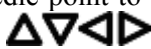

2. Press .

3. Move the needle point to the reference point of resizing with .

4. Press .

If  is selected

Data chunks separated with feed data are resized and copied.

If the number of feed boundaries to be ignored is 0:

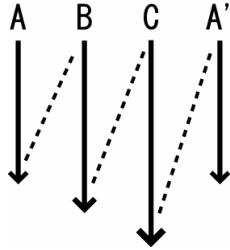

Only A is copied.
A' becomes a split program.

If the number of feed boundaries to be ignored is 1:

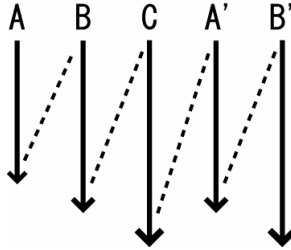

A and B are copied.
A' and B' become split programs.

If the number of feed boundaries to be ignored is 2:

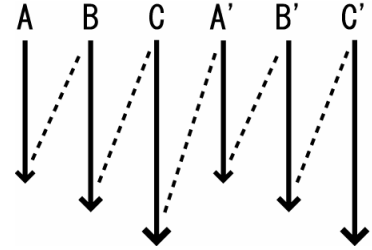

Data unit A, B and C are copied.
A', B' and C' become split programs.



1. Input a resizing scale in the X and Y directions, stitch length, and the number of feed boundaries to ignore.

Resizing scale between 0 and 400% are available.

If the stitch length is 0.0, the pattern is resized with the same number of stitches as the original data.

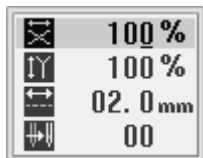
Inputting 99 as the number of feed boundaries to ignore ignores all boundaries.



2. Press .
3. Move the needle point to the reference point of resizing with .

When using the home position as the reference point, there is no need to follow this step.

4. Press .

The copied data is added as split data.

If  is selected

1. Input a resizing scale in the X and Y directions and stitch length.

Resizing scale between 0 and 400% are available.

If the stitch length is 0.0, the pattern is resized with the same number of stitches as the original data.



2. Press .

If  is selected

1. Input a resizing scale in the X and Y directions and stitch length.

Resizing scale between 0 and 400% are available.

If the stitch length is 0.0, the pattern is resized with the same number of stitches as the original data.

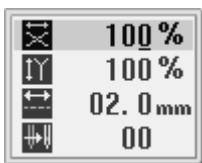



2. Input the number of feed boundaries to be ignored, and then press .

For the method to ignore all feed boundaries, refer to "If  is selected" (page 83).

If  **is selected**

1. Input the rotation direction and the angle of rotation, and then press .





2. Move the needle point to the rotational reference point with . Press .

If  **is selected**

1. Input the rotation direction, the angle of rotation and the number of feed boundaries to ignore, and then press .

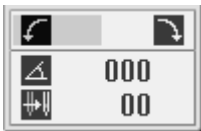
For the method to ignore all feed boundaries, refer to "If  is selected" (page 83).





2. Move the needle point to the rotational reference point with . Press .

If  **is selected**

1. Input the rotation direction and the angle of rotation, and then press .



If  **is selected**

1. Input the rotation direction, the angle of rotation and the number of feed boundaries to ignore, and then press .

For the method to ignore all feed boundaries, refer to "If  is selected" (page 83).

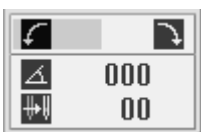



Deleting program being created/edited

Delete program being edited.

1. Press or to display the programming screen.

2. Select , and then press .

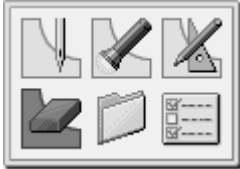

The confirmation screen appears.

3. Press to delete program, and then press to cancel this command.

Chapter 4

Programming with Commands

Programming with commands

Pressing combinations of specific keys on this machine allows programming. These key combinations are called 'commands'. This chapter describes the method of programming with commands.

* Other than programming with commands, programming with icons is also possible. Holding  down allows users to switch between the mode for programming with icons and the mode for programming with commands.

⇒ Refer to Chapter 3 "Programming with Icons" (page 22).

Keys to be used

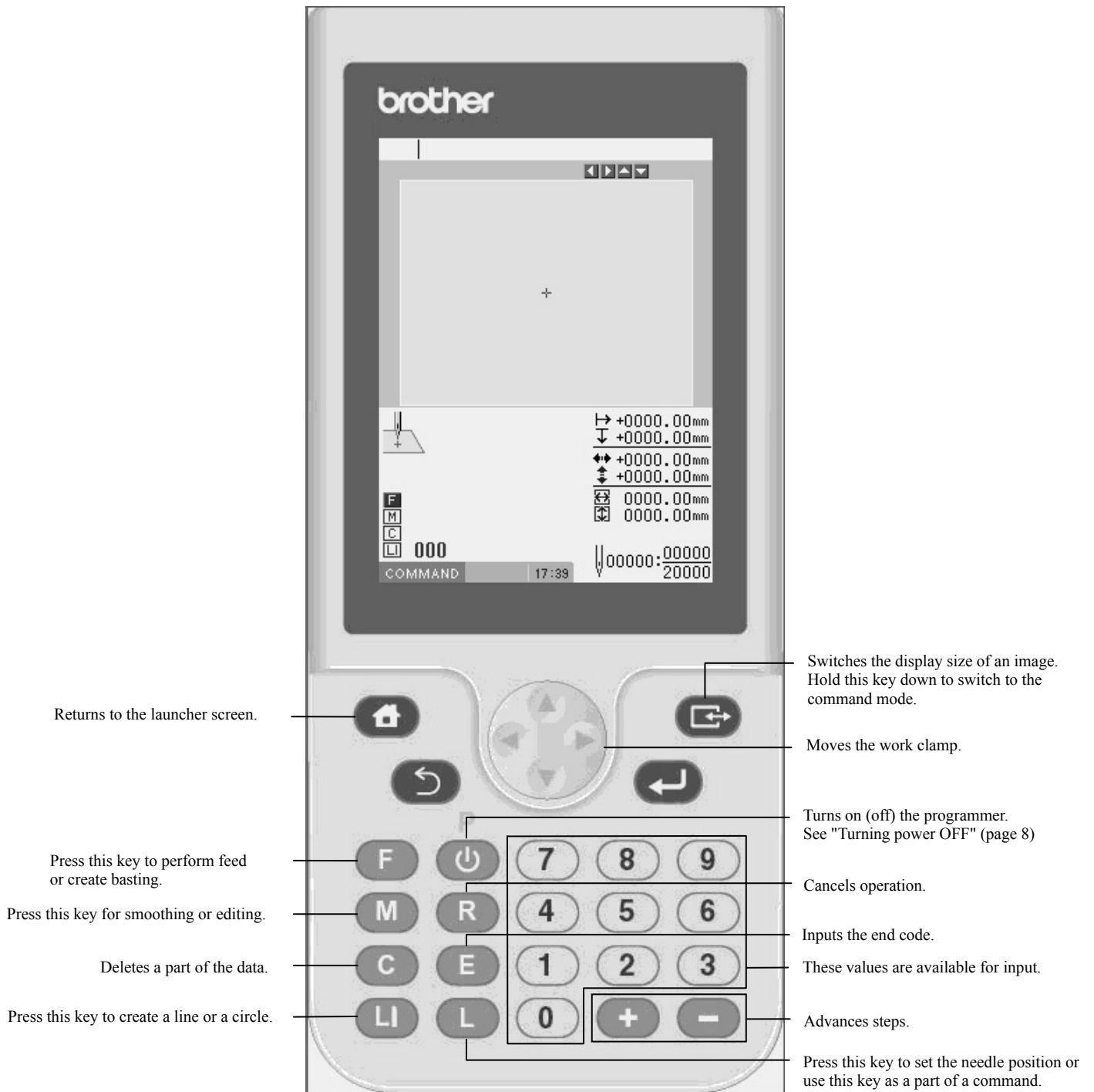

Programming screen

On the launcher screen, select the  icon and press  to display the programming screen. If the screen is not displayed, hold  down.

* When the following message is displayed, press  to program without operating the sewing machine.

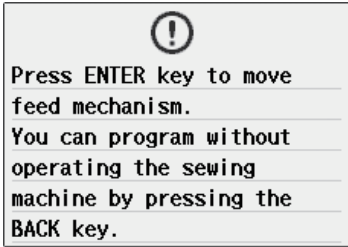

* When the following message is displayed, press  to program without operating the sewing machine.

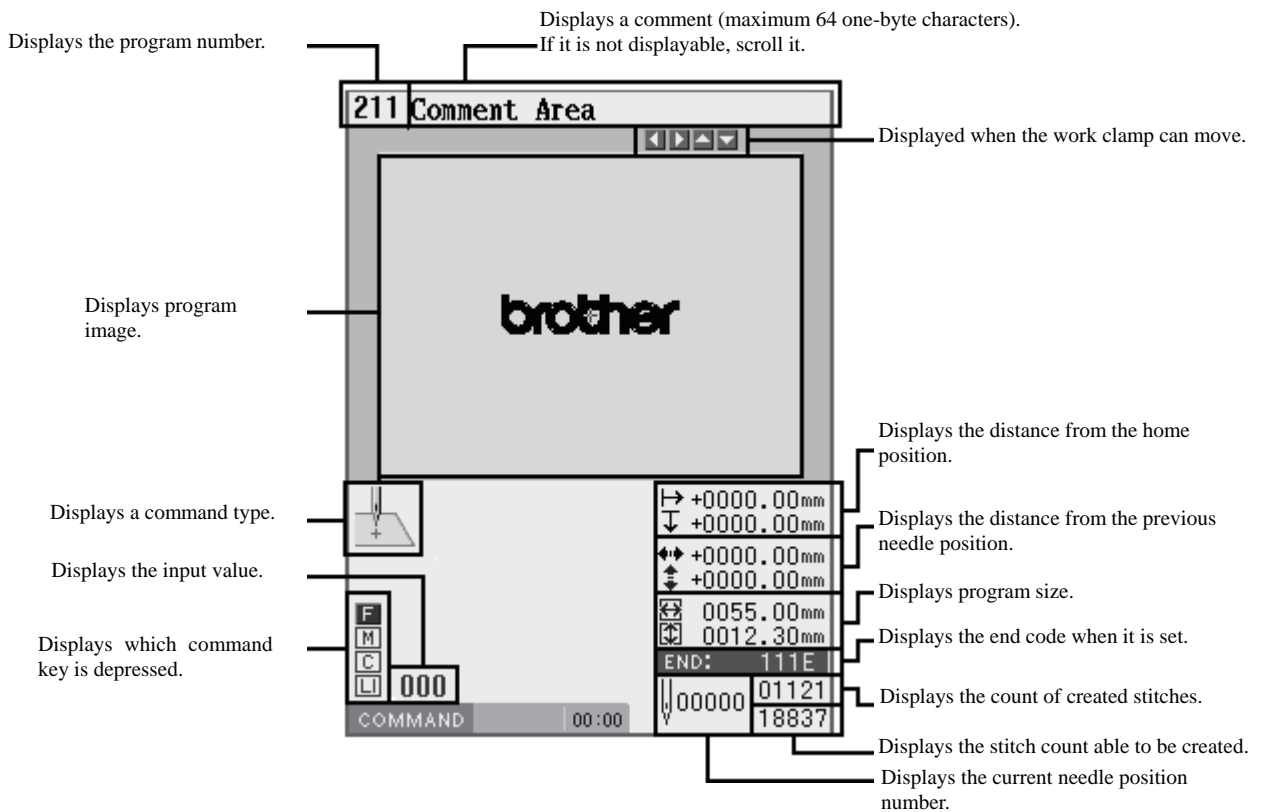
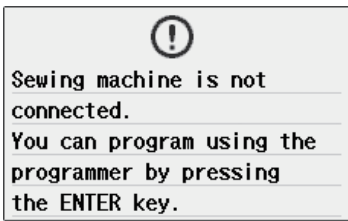

Description of Commands

Moving needle point

<input type="text"/> <input type="text"/> <input type="text"/> +	Proceeding by <input type="text"/> <input type="text"/> <input type="text"/> stitches
<input type="text"/> <input type="text"/> <input type="text"/> -	Returning by <input type="text"/> <input type="text"/> <input type="text"/> stitches
<input type="text"/> 9 <input type="text"/> 9 <input type="text"/> 9 +	Proceeding to the end point
<input type="text"/> 9 <input type="text"/> 9 <input type="text"/> 9 -	Returning to the first point
F <input type="text"/> <input type="text"/> <input type="text"/> <input type="text"/> +	Proceeding by skipping <input type="text"/> <input type="text"/> <input type="text"/> stitches
F <input type="text"/> <input type="text"/> <input type="text"/> <input type="text"/> -	Returning by skipping <input type="text"/> <input type="text"/> <input type="text"/> stitches
F <input type="text"/> 9 <input type="text"/> 9 <input type="text"/> 9 +	Skipping to the end point (not applicable at the home position)
F <input type="text"/> 9 <input type="text"/> 9 <input type="text"/> 9 -	Skipping to the first point
R	Returning the position to the home position

Programming

Line	<input type="text"/> <input type="text"/> <input type="text"/> LI	Creating a line (Input the stitch length in <input type="text"/> <input type="text"/> <input type="text"/> .)
Curve	<input type="text"/> <input type="text"/> <input type="text"/> M	Creating a curve (Input the stitch length in <input type="text"/> <input type="text"/> <input type="text"/> .)
	7 8 9 L	Ending input for a curve
Circle	2 0 <input type="text"/> LI	Creating a circle by specifying 3 points on the circumference (Input the overlap stitch counts in <input type="text"/> .)
	2 1 <input type="text"/> LI	Specifying a diameter to create a clockwise circle (Input the overlap stitch counts in <input type="text"/> .)
	2 2 <input type="text"/> LI	Specifying a diameter to create a counterclockwise circle (Input the overlap stitch counts in <input type="text"/> .)
	2 3 <input type="text"/> LI	Specifying a radius to create a clockwise circle (Input the overlap stitch counts in <input type="text"/> .)
	2 4 <input type="text"/> LI	Specifying a radius to create a counterclockwise circle (Input the overlap stitch counts in <input type="text"/> .)
Arc	3 0 0 LI	Creating an arc by specifying 3 points
Semicircle	3 1 0 LI	Creating a clockwise semicircle
	3 2 0 LI	Creating a counterclockwise semicircle
Zigzag	7 <input type="text"/> <input type="text"/> M	Creating a zigzag stitch (After inputting the width of the zigzag in <input type="text"/> , input the pitch of the zigzag stitch in <input type="text"/> <input type="text"/> <input type="text"/> M.)
	7 8 7 L	Carrying out a zigzag stitch on the right side of the sewing path
	7 8 8 L	Carrying out a zigzag stitch on the left side of the sewing path
	7 8 9 L	Carrying out a zigzag stitch symmetrical to the sewing path
Splitting	2 2 0 L	Stopping the needle at the upper end by split
	2 2 1 L	Stopping the needle at the lower end by split
Magnified input	9 0 2 M	Magnified input ($\times 2$)
	9 0 5 M	Magnified input ($\times 5$)
	9 1 0 M	Magnified input ($\times 10$)

Double stitch	2 <input type="text"/> <input type="text"/> M	Creating a double stitch in the reverse direction of the sewing path (Input the width of the double stitch in <input type="text"/> <input type="text"/>)
	7 8 8 L	Carrying out a double stitch on the right side of the sewing path
	7 8 9 L	Carrying out a double stitch on the left side of the sewing path
Parallel stitch	3 <input type="text"/> <input type="text"/> M	Creating a parallel stitch in the same direction as the sewing path (Input the width of parallel stitch in <input type="text"/> <input type="text"/>)
	7 8 8 L	Carrying out a parallel stitch on the right side of the sewing path
	7 8 9 L	Carrying out a parallel stitch on the left side of the sewing path
Offset	4 <input type="text"/> <input type="text"/> M	Creating an offset (Input the width for offset in <input type="text"/> <input type="text"/>)
	7 8 8 L	Carrying out an offset on the right side of the sewing path
	7 8 9 L	Carrying out an offset on the left side of the sewing path
Basting	F 8 8 8 L	Creating split data after basting data
	F 9 9 9 L	Creating basting data
Feed	F 6 6 6 L	Specifying split points (for sewing different patterns separately in a sequence) after feed
	F 7 7 7 L	Moving in parallel for the feed
Multiple stitch	5 0 0 M	Starting a multiple stitch
	5 <input type="text"/> <input type="text"/> M	Creating a multiple stitch (Input the number of lines for a multiple stitch in <input type="text"/> <input type="text"/>)
Trace	5 <input type="text"/> <input type="text"/> L	Creating data by tracing a pattern

Editing program

0 0 1 M	Moving a pattern symmetrical to the Y-axis
0 1 0 M	Moving a pattern symmetrical to the X-axis
0 1 1 M	Moving a pattern symmetrical to a point
5 <input type="text"/> <input type="text"/> M	Retrying a multiple stitch (Input the number of lines for a multiple stitch in <input type="text"/> <input type="text"/>)
6 6 6 M	Rotating a pattern clockwise
6 6 7 M	Rotating a pattern counterclockwise
6 7 6 M	Copying a rotated pattern clockwise
6 7 7 M	Copying a rotated pattern counterclockwise
8 8 8 M	Resizing a pattern (Input the magnification in the X direction in <input type="text"/> <input type="text"/> <input type="text"/> F , and input the magnification in the Y direction in <input type="text"/> <input type="text"/> <input type="text"/> M .)
9 9 9 M	Copying a resized pattern (Input the magnification in the X direction in <input type="text"/> <input type="text"/> <input type="text"/> F , and input the magnification in the Y direction in <input type="text"/> <input type="text"/> <input type="text"/> M .)
3 3 3 L	Repeated copying
4 4 0 L	Copying symmetrically to a point
4 4 1 L	Copying a pattern symmetrically to the X-axis
4 4 2 L	Copying a pattern symmetrically to the Y-axis
4 4 3 L	Copying in the reverse direction

(7) (7) (7) (L)	Moving data in parallel before the current needle position (changing the moving amount data of the needle position)
(L) (7) (7) (7) (L)	Moving data in parallel after the current needle position (using needle drop data to the moved-to position)

Setting attribute

(1) () () (L)	Setting the number of feed boundaries to be ignored (0 to 99)
(2) (3) (0) (L)	Stopping the needle at the upper end (only when the needle position is at split)
(2) (3) (1) (L)	Stopping the needle at the lower end (only when the needle position is at split)
(6) (6) (6) (L)	Setting the maximum sewing speed at 400 rpm or lower
(6) (6) (7) (L)	Setting the maximum sewing speed at 1200 rpm or lower
(6) (6) (8) (L)	Setting the maximum sewing speed at 800 rpm or lower
(6) (6) (9) (L)	Setting the maximum sewing speed at 600 rpm or lower
(6) (6) (0) (L)	Canceling low speed data setting
(7) (7) (1) (L)	Turning on option output 1
(7) (7) (2) (L)	Turning on option output 2
(7) (7) (3) (L)	Turning on option output 3
(7) (7) (0) (L)	Turning off all option outputs
(9) (0) (0) (L)	Canceling setting for the height of presser foot
(9) () () (L)	Setting the height of presser foot (Input the height of presser foot from 00 to 99 in () ().)
(9) (8) (0) (L)	Not breaking thread for feed (only when the needle position is at feed)
(9) (8) (1) (L)	Breaking thread for feed (only when the needle position is at feed)
(9) (9) (0) (L)	Canceling basting data setting

Deleting program

(2) (2) (2) (R)	Deleting all data
(C) () () () (+)	Deleting data from () () () stitches
(C) () () () (-)	Deleting data before () () () stitches

Ending programming

(1) (1) (1) (E)	Normal end
(1) (1) (2) (E)	Fixing the sewing speed at 1200 rpm or lower
(1) (1) (3) (E)	Carrying out no thread wiping
(1) (1) (4) (E)	Setting the sewing speed at 1200 rpm or lower without thread wiping
(1) (1) (5) (E)	Carrying out no thread trimming
(1) (1) (6) (E)	Fixing the sewing speed at 1500 rpm or lower

Other operations



Returning to the launcher screen



Switching the display size of an image
Hold this key down to switch to the command mode



Turning on (off) the programmer



Canceling command

Procedure for programming with commands

The procedure for programming with commands is as follows.

1. Displaying the programming screen

Press . On the launcher screen, select icon. Press to display the programming screen.

If the screen is not display, hold down.

The work clamp moves to the home position and the programming screen is displayed.

2. Positioning the machine needle point at the first stitch of pattern sheet

Move the work clamp using . Press when the needle point is at the first stitch of the pattern sheet.



The first stitch is programmed and the following screen appears.



3. Creating program

Input a command depending on your purpose for creating program for the pattern you want to create. The program is available until deletion. For details about program creations, refer to "Programming example" (page 95)/"Programming" (page 120).

4. Inputting an end code

When programming is completed, input an end code to control the machine operation. The following six end codes from 111 to 116 are available, each of which are set as shown in the table below. Program with no end code set is not available on the machine.

To prevent incompleting program from being used by mistake, you can choose not to set any end code.

	Normal end
	Fixing the sewing speed at 1200 rpm or lower
	Carrying out no thread wiping
	Setting the sewing speed at 1200 rpm or lower without thread wiping
	Carrying out no thread trimming
	Fixing the sewing speed at 1500 rpm or lower

1. Input an end code.

is selected in the example.

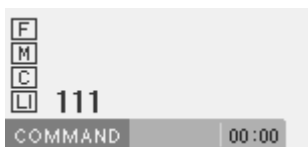

The work clamp returns to the first stitch.

5. Saving the created program

Specify the program number on the operation panel and press the read/write switch for writing into a media.
For details of operations, refer to Chapter 6 "Saving program" (page 178).

6. Ending programming

Press .

Programming example

This section describes the programming methods using specific examples.

Programming for each stitch: Page 95

Program a detailed pattern for each stitch (magnified input): Page 96

Pattern with lines: Page 96

Pattern with curves: Page 97

Double stitch: Page 98

Continuous sewing with the work clamp in position after thread trimming: Page 99

Basting: Page 100

Symmetrical pattern: Page 101

Programming multiple patterns by splitting each in sequence (split): Page 102

Zigzag stitch: Page 103

Multiple stitch: Page 104

Programming by tracing a pattern (trace): Page 106



* For more information about the functions and operations of each command, refer to "Programming" (page 120).

* In the programming example, point A in the illustration is the first stitch.

Programming for each stitch

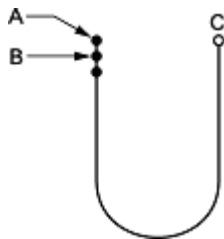
The following describes how to perform programming for each stitch according to the pattern sheet.



1. Carry out steps 1 and 2 of "Procedure for programming with command".
2. Move the work clamp with . Press  when the needle point is at B.
3. Create the program to point C as in step 2.
4. Carry out steps 4 to 6 of "Procedure for programming with command".

Programming a detailed pattern for each stitch (magnified input)

Use "magnified input" to accurately program a detailed pattern stitch by stitch. The following describes how to program the pattern below by magnifying it five time. (This function is available only when the work clamp is at the home position. When it is not at the home position, press **R** to move it there.)

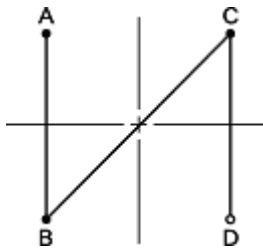

1. Carry out step 1 of "Procedure for programming with command".
2. Press **9 0 5 M**.

9 is the command for magnified input. Input the magnification (02, 05, 10) in .

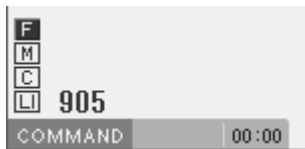

3. Move the work clamp with **Δ▽◀▶**. Press **L** when the needle point is at B.
4. Create the program to points C and D as in step 3.
5. Carry out steps 4 to 6 of "Procedure for programming with command".

Pattern with lines

The following describes how to program a pattern with lines.

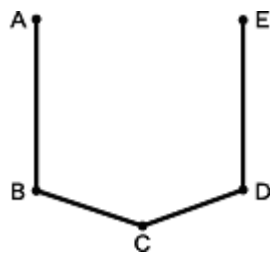

1. Carry out all the steps up to step 2 of "Procedure for programming with command".
2. Input the stitch length.
3.0 mm is input in the example.
Input "030" to make the stitch length 3.0 mm.



3. Press **LI**.
To change the stitch length, specify the pitch value before pressing **LI**.
4. Move the work clamp with **Δ▽◀▶**. Press **L** when the needle point is at B.
5. Create the program to points C, D, and E as in steps 3 and 4.
6. Carry out steps 4 to 6 of "Procedure for programming with command".

Pattern with curves

The following describes how to program a pattern with curves.

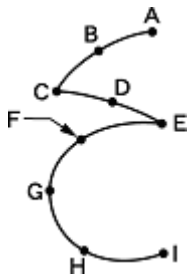

Be sure to press **7 8 9 L** to make a split at a corner point C or E. If a split is not made, the corner will be rounded.

When a split is made



When a split is not made



Making more intermediate points such as points B, D, F, G, and H create smooth curves.

1. Carry out steps 1 and 2 of "Procedure for programming with command".
2. Input the stitch length, and then press **M**.
3.0 mm is input in the example.
Input "030" to make the stitch length 3.0 mm.



3. Move the work clamp with **Δ▽◀▶**. Press **L** when the needle point is at B.

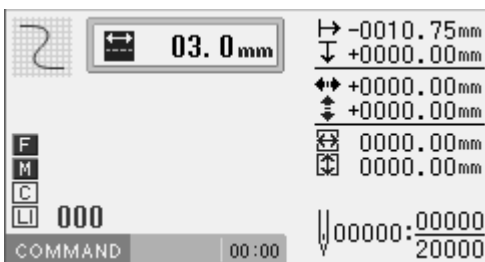

4. Move the work clamp with **Δ▽◀▶**. Press **7 8 9 L** when the needle point is at point C of the pattern.

Point C becomes a sharp corner. The points A to C are programmed.

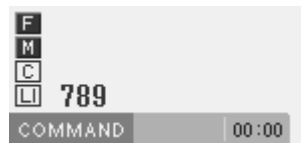

5. Press **M**.
To change the stitch length, specify the pitch value before pressing **M**.
6. Move the work clamp with **Δ▽◀▶**. Press **L** when the needle point is at D of the pattern.
7. Repeat step 6 and create the program to point E.
8. Press **7 8 9 L** as in step 4.
The points C to E are programmed.
9. Create the program to point I in the similar manner.
10. When point I is programmed, press **7 8 9 L** again.
11. Carry out steps 4 to 6 of "Procedure for programming with command".

Double stitch

Use “double stitch” to program two parallel lines. The following describes how to program the double stitch to the left of the sewing direction.

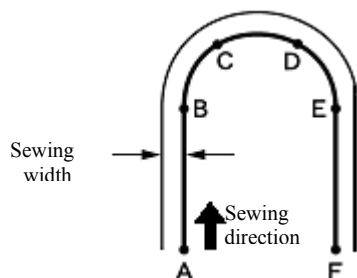

Be sure to press **7 8 9 L** at a point B or E where the line changes to the curve.

Placing more intermediate points such as points C and D create smooth curves.

1. Carry out steps 1 and 2 of "Procedure for programming with command".

2. Press **2 3 0**, and then press **M**.

2 is the command for the double stitch.

Input the width of the double stitch in .

3.0 mm is input in the example.

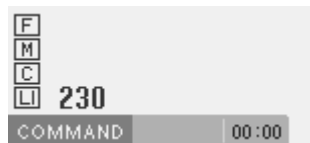

3. Input the stitch length and press **M**.

3.0 mm is input in the example.

Input "030" to make the stitch length 3.0 mm.

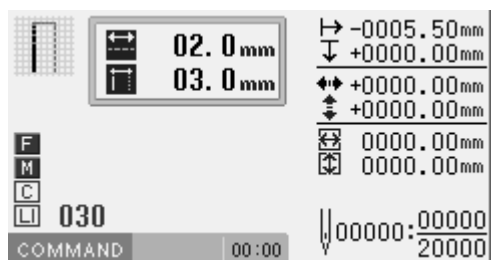

4. Program points B, C, D and E.

5. When point E is programmed, press **7 8 9 L** again to make a split.

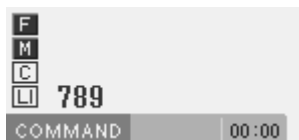

6. Program point F.

7. When point F is programmed, press **7 8 9 L** again.

8. After pressing **L**, input an end code.

The needle moves to points F, G and H.

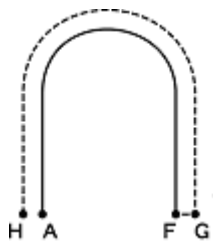

9. Carry out steps 5 and 6 of "Procedure for programming with command".

Continuous sewing with the work clamp in position after thread trimming (feed)

Set “feed” to continue sewing with the work clamp in position after thread trimming. The following describes how to program pattern 2 with a feed after pattern 1.



1. Carry out all the steps up to step 2 of "Procedure for programming with command".
2. Program pattern 1.
Refer to "Pattern with lines" (page 96).

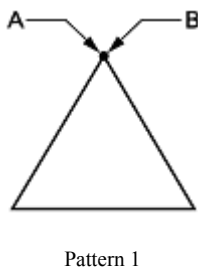

3. Press **F** after input of point B.

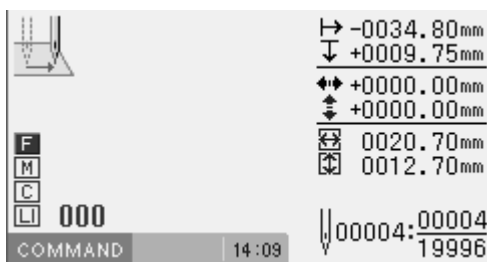

4. Move the work clamp with **△▽◀▶**. Press **L** when the needle point is at point C of the pattern sheet.

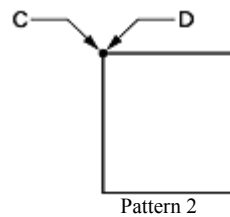

5. Program pattern 2.
Refer to "Pattern with lines" (page 96).
6. Carry out steps 4 to 6 of "Procedure for programming with command".

Basting

The following describes how to program basting from point C to F.

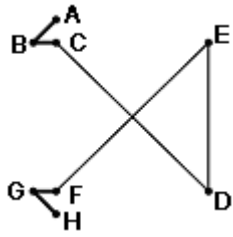

1. Carry out steps 1 and 2 of "Procedure for programming with command".
2. Move the work clamp with $\Delta \nabla \triangleleft \triangleright$. Press **L** when the needle point is at point B.

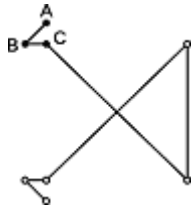

3. Program point C as in step 2.
4. Press **9 9 9 F**.

Input the basting command.



5. Move the work clamp with $\Delta \nabla \triangleleft \triangleright$. Press **L** when the needle point is at point D of the pattern.
6. Program points E and F as in steps 4 and 5.
7. Program points G and H as in step 2.
8. Carry out steps 4 and 6 of "Procedure for programming with command".

Symmetrical pattern

When programming a symmetrical pattern, program a target pattern and then select a symmetrical pattern type. The following describes how to program a pattern symmetric to the Y axis.

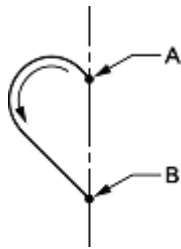

Symmetrical pattern type



Symmetric to Y axis

Use the command **4 4 2** **L**.

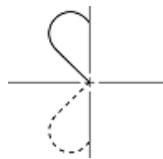

Symmetric to X axis

Use the command **4 4 1** **L**.

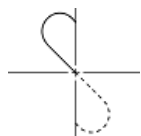

Symmetric to point

Use the command **4 4 0** **L**.

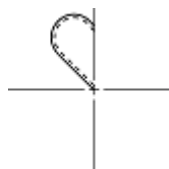

Turnover

Use the command **4 4 3** **L**.

1. Carry out steps 1 and 2 of "Procedure for programming with command".
2. Create the program to point B.
Refer to "Programming for each stitch" (page 95) or "Pattern with curves" (page 97).
3. Press **4 4 2** **L**.

Input the symmetric to Y axis command.

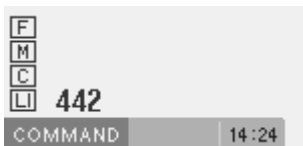

4. The needle point moves slowly from point B to point A in the right half and a symmetrical pattern is automatically programmed. Press **+** to move the needle point faster.

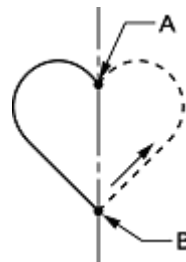

5. Carry out steps 4 to 6 of "Procedure for programming with command".

Programming multiple patterns by splitting each in sequence (split)

Multiple patterns are programmed splitting each pattern in sequence. The following describes how to program 3 patterns in sequence.

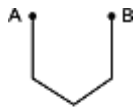







Pattern 1



Pattern 2



Pattern 3

1. Carry out steps 1 and 2 of "Procedure for programming with command".
2. Program pattern 1.
Refer to "Pattern with lines" (page 96).
3. Move the work clamp with . Press  when the needle point is at point B of the pattern sheet.
4. Move the work clamp with . Press     when the needle point is at point C of the pattern sheet.
5. Program pattern 2.
Refer to "Pattern with lines" (page 96).
6. Program pattern 3 in the same way.
Refer to "Pattern with lines" (page 96).
7. Carry out steps 4 to 6 of "Procedure for programming with command".

To change the pattern, press the pressure holder lift switch and replace the pattern.

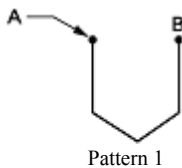

Pattern 1



Pattern 2

Zigzag stitch

The following describes how to program zigzag stitch so that the sewing start point (A) is laterally centered.

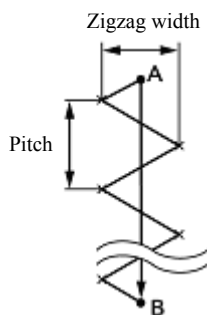

Curving zigzag stitches are also programmable.

1. Carry out steps 1 and 2 of "Procedure for programming with command".

2. Press **7 3 0**, and then press **M**.

7 **M** is the command for the zigzag stitch.

Input the width of the zigzag stitch in .



3. Input the stitch length, and then press **M**.

3.0 mm is input in the example.

Input "030" to make the stitch length 3.0 mm.

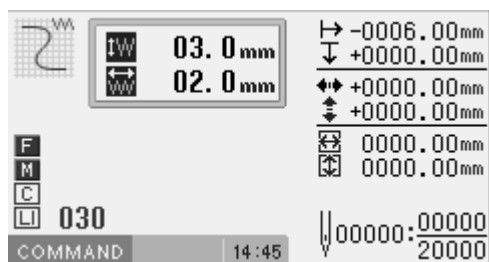

4. Move the work clamp with **Δ▽◀▶**. Press **L** when the needle point is at B of the pattern.

5. Press **7 8 9 L**.

Zigzag stitch with even width to the left and the right is programmed.



6. Carry out steps 4 to 6 of "Procedure for programming with command".

Multiple stitch

The following describes how to program multiple stitches.

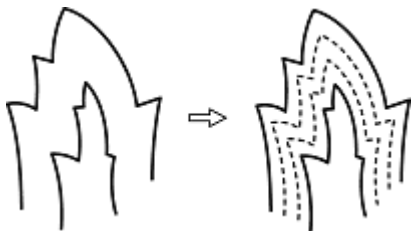

Programming is possible from a line on either the inside or the outside. Sewing is carried out in order of programming and in the programmed direction.

When the sewing direction is changed at a sharp angle, provide a split in the vicinity of the direction change point for finishing the multiple stitch in relatively uniform conditions.

Up to 200 points can be specified for either the inside or the outside. If you attempt to input 201 or more points, the needle point is automatically returned to the previous point. In that case, start inputting points from another side (either the inside or the outside) line, or change the point input position or pattern.

Creating a stitch pattern

1. Create a pattern combining the outer and inner lines for a multiple stitch.

The two lines should be spaced uniformly apart.

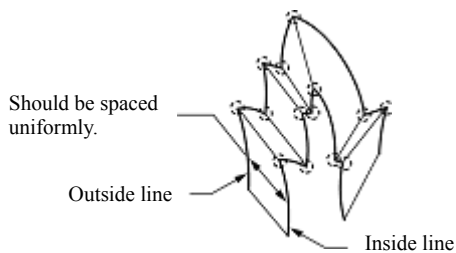

2. Connect direction change points in pairs on the inner and outer lines using a line.

3. Create at least 1 point between the direction change points on both the inner and outer lines, and connect the points in pairs along the inner and outer lines using another line.

Place these points in the same way as creating a curve. Refer to "Pattern with curves" (page 97).

Specify direction change points in pairs on the inner and outer lines. The lines should be spaced uniformly apart.

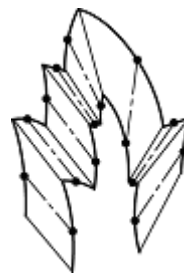

Programming

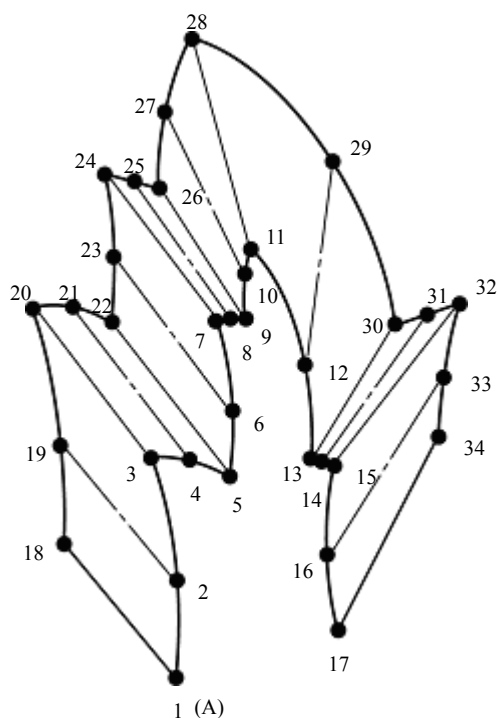

1. Carry out steps 1 and 2 of "Procedure for programming with command".
2. Press **5 0 0**, and then press **M**.



3. Move the work clamp with **Δ▽◀▶**. Press **L** when the needle point is at point 2 of the pattern sheet.
4. Move the work clamp with **Δ▽◀▶**. Press **7 8 9 L** when the needle point is at point 3 of the pattern sheet.

Be sure to press **7 8 9 L** for a split at a corner such as point 3. If a split is not made, the corner will be rounded.

5. Program the following noted points up to point 17 with the curve programming steps.

When there is a liner section, move the needle point from the split to the next split, and press **7 8 9 L**.

In the example, a linear line is programmed between points 7 and 9. Be sure to also program a linear line for the matched section between points 24 and 26.

To return the needle point, follow the steps below.

Returning to the previous point: Press **0 -**. (The needle cannot be returned beyond the previous split.)

Returning the previous split: Press **1 -**. (When the needle position is at a split, it cannot be moved.)

Returning to the split before the previous one: Press **2 -**.

6. Press **F** and move the work clamp with **Δ▽◀▶**. Press **L** when the needle point is at point 18 of the pattern.
7. Program the following points up to point 34 in the same manner.

When programming, be sure that the points and splits specified on the inner line are paired respectively with those on the outer line.

If there are any points or splits that are not paired, the needle automatically returns to the previous point. Correct the program.

8. Press **5**, and then press **M**.

Input the number of lines for a multiple stitch in **0 0**.

When the number is "5", input "505".

9. Input the stitch length, and then press **M**.

3.0 mm is input in the example.

Input "030" to make the stitch length 3.0 mm.

10. Press **L**.

If the number of lines for a multiple stitch has not been input, a buzzer sounds.

If this occurs, repeat step 8.

11. Carry out steps 4 to 6 "Procedure for programming with command".

Programming by tracing a pattern (trace)

Carry out programming by using the numeric keys and  so that the needle point accurately traces a pattern. The following describes how to program the pattern below.

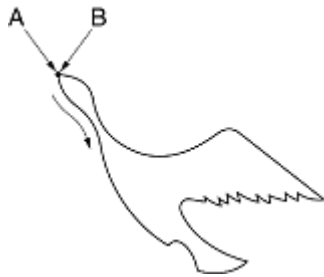

1. Carry out steps 1 and 2 of "Procedure for programming with command".

2. Press    .

3. Input the stitch length.

3.0 mm is input in the example.

Input "030" to make the stitch length 3.0 mm.

* It is automatically set at 2 mm if a stitch length is not specified or it is specified to 0.2 mm or less, or 12.7 mm (displayed as 127) or more.







4. Start operating the needle at the sewing start point A using  so that the needle point accurately traces the pattern.

5. Press  when the needle point is at point B.

6. Carry out steps 4 to 6 "Procedure for programming with command".



(Note 1) At positions where you are required to sew with care (such as corners at sharp angles or delicate parts), carry out programming using . This will create a corner with clear stitching.

(Note 2)  or  can also be used during programming. If you use these keys, press  at the start and end points for skip sewing and line stitching.

Procedure for modifying program

Procedure for modifying the program by using commands is as follows.

1. Calling program to be modified

Specify the program number on the operation panel and press the read/write switch to read the program.

Programming with icons is also possible.

Refer to Chapter 3 "Programming with Icons" (page 21).

2. Starting program modification

Input a command depending on your purpose to modify the program.

For details of program modification, refer to "Example of modified program" (page 108).

3. Saving the modified program

Specify the program number on the operation panel and press the read/write switch for writing into a media.

Programming with icons is also possible.

Refer to Chapter 3 "Programming with Icons" (page 21).

4. Ending programming

Press .

This section describes the program modification methods using specific examples.

Resizing a pattern: Page 109

Modifying a part of a pattern: Page 110

Deleting the first stitch to change the second stitch to the sewing start point: Page 111

Moving the sewing start point: Page 112

Adding a new sewing start point before the first stitch: Page 113

Adding an escape point before the sewing start point: Page 114

Moving the escape point: Page 115

Deleting the escape point: Page 116

Moving the pattern in parallel (when the first stitch is the sewing start point): Page 116

Moving the pattern in parallel (when the first stitch is the escape point): Page 117

Deleting a portion of the data during programming: Page 118

Modifying a part of a continuous program in parallel: Page 119

Not breaking the thread at the last stitch: Page 119

Resizing a pattern

The following describes how to resize a programmed pattern.

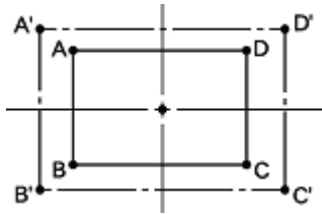

The reference point of resizing can be changed. The magnifying direction varies depending on the position of the reference point.

If the reference point is not determined, the pattern is resized on the basis of the home position.

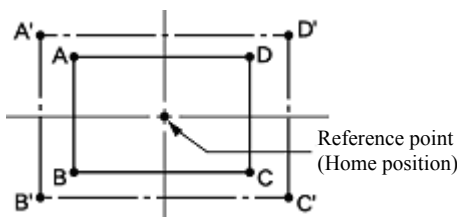

If the reference point is determined, the pattern is resized on the basis of the reference point.

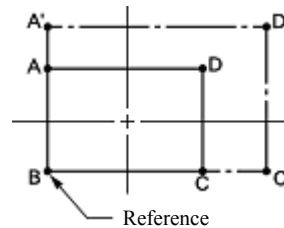

1. Carry out step 1 of "Procedure for modifying program" to call program.
2. Move the needle to the reference point of resizing with $\Delta \nabla \triangleleft \triangleright$.

When resizing the pattern to the home position, there is no need to move the needle.

3. Press 8 8 8 , and then press M .

Input the resizing command.

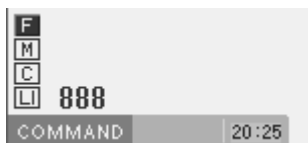

4. Press 1 5 0 , and then press F .

Input the resizing percentage for the X-axis. Enter the 3 digit number in 000 to specify the magnification percentage. 150% is specified in the example.

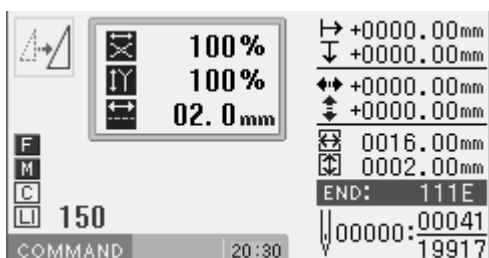

5. Press 1 5 0 , and then press M .

Input the resizing percentage for the Y-axis. Enter the 3 digit number in 000 to specify the magnification percentage. 150% is specified in the example.

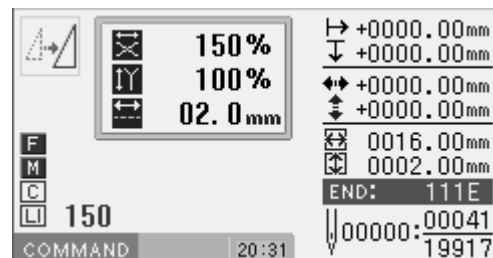

6. Input the stitch length, and then press L .

If the stitch length is 0.0, the pattern is resized keeping the number of stitches of the original data.

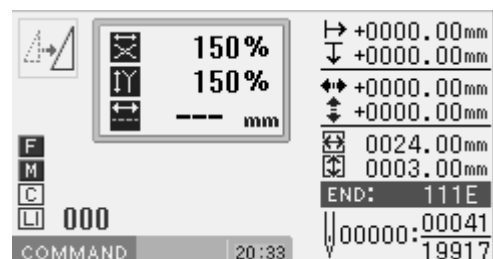

7. Carry out steps 3 and 4 of "Procedure for modifying program" to save program.

Modifying a part of pattern

A part of the programmed pattern is changed. The following describes how to modify 5, 6 and 7 to 5', 6' and 7'.

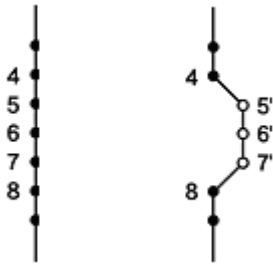

1. Carry out step 1 of "Procedure for modifying program" to call program.

2. Press **9 9 9**, and then press **+**.

The work clamp moves from the start point by each stitch.

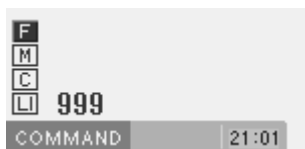

3. When the needle point reaches 4, press **-**.

The work clamp stops. When returning the needle point, input the number of stitches to be returned and press **-**.

4. Move the work clamp with **Δ ∇ ◀ ▶**. Press **L** when the needle point is at 5'.

5. Program 6' and 7' as in step 4.

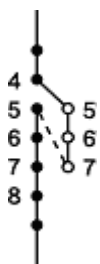

6. Press **1**, and then press **+**.

The needle point moves to 5.

7. Press **C**.

8. Input the number of stitches to be deleted, and then press **+**.

In the example, 3 stitches ahead are deleted: press **3 +**.

The needle point moves to 6, 7 and 8. Points 5, 6 and 7 are deleted.

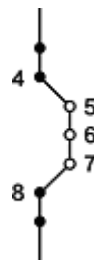

9. Carry out steps 3 and 4 of "Procedure for modifying program" to save program.

Deleting the first stitch to change the second stitch to the sewing start point

The following describes how to delete the sewing start point of a programmed pattern to make the second stitch as the sewing start point.

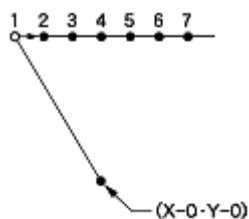

1. Carry out step 1 of "Procedure for modifying program" to call program.
2. Press **1**, and then press **+**.
The work clamp moves to the sewing start point.
3. Press **C**.
4. Input the number of stitches to be deleted, and then press **+**.

In the example, the first stitch is deleted. Press

1 **+**.

The needle point moves to 2.

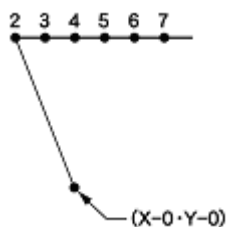

5. Carry out steps 3 and 4 of "Procedure for modifying program" to save program.

Moving the sewing start point

The following describes how to move the sewing start point from 1 to 1'.

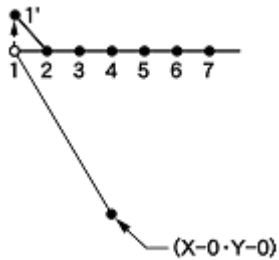

1. Carry out step 1 of "Procedure for modifying program" to call program.
2. Press **1**, and then press **+**.
The work clamp moves to the sewing start point.
3. Move the work clamp with **▲▼◀▶**. Press **L** when the needle point is at point 1' of the pattern sheet.
1' is programmed.
4. Press **1**, and then press **-**.
The work clamp moves to the sewing start point.
5. Press **C**.

6. Input the number of stitches to be deleted, and then press **+**.

In the example, the first stitch is deleted. Press **1** **+**.

The needle point moves to 1'.

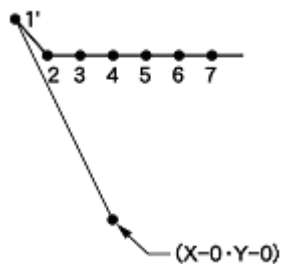

7. Carry out steps 3 and 4 of "Procedure for modifying program" to save program.

Adding a new sewing start point before the first stitch

A point is added before the current sewing start point to make it as the sewing start point. The following describes how to change the sewing start point from 1 to 1'.

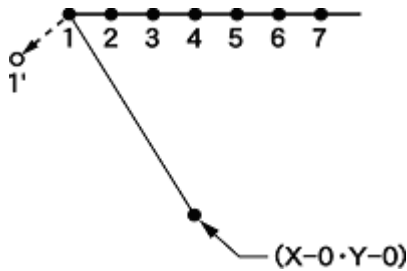

1. Carry out step 1 of "Procedure for modifying program" to call program.
2. Press **1**, and then press **+**.
The work clamp moves to the sewing start point.
3. Press **F**.
4. Move the work clamp with **Δ▽◀▶** so that the needle point is at 1' of the pattern sheet.

Record the coordinates (values of **↔** and **↕**).

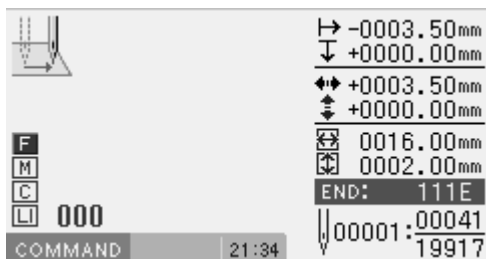

5. Press **L**.
1' is programmed.
6. Move the work clamp with **Δ▽◀▶** an equivalent of the coordinate value recorded in step 4 to the opposite direction. Press **L**.
If the moving distance is long, press **LI**.

7. Press **R**.
The work clamp returns to the home position.
8. Press **1**, and then press **+**.
The needle point returns to the first stitch.
9. Press **C**.
10. Input the number of stitches to be deleted, and then press **+**.

In the example, the first stitch is deleted. Press **1** **+**.

The needle point moves to 1'.

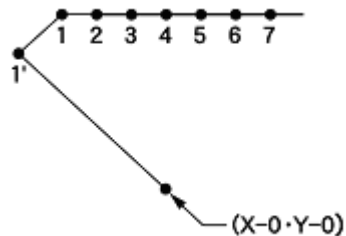

11. Carry out steps 3 and 4 of "Procedure for modifying program" to save program.

Adding an escape point before the sewing start point

The following describes how to set the escape point A before the sewing start point.

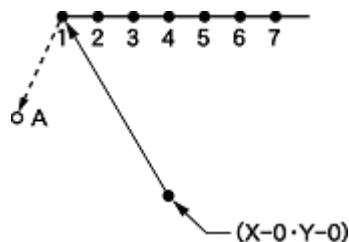

* The escape point is a provisional point provided for preventing the work clamp from interfering with the needle or presser foot when the work clamp is lifted at the start point.

1. Carry out step 1 of "Procedure for modifying program" to call program.
2. Press **1**, and then press **+**.
The work clamp moves to the sewing start point.
3. Press **F**.
4. Move the work clamp with **Δ▽◀▶** so that the needle point is at A of the pattern sheet.

Record the coordinates (values of **↔** and **↕**).

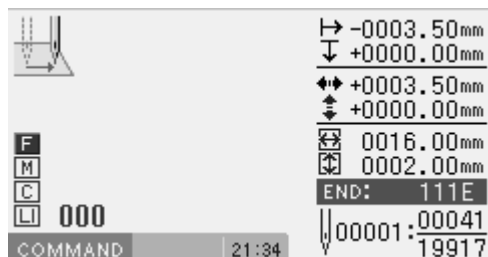

5. Press **L**.
A is programmed.
6. Press **F**.
7. Move the work clamp with **Δ▽◀▶** an equivalent of the coordinate value recorded in step 4 in the opposite direction so that the needle point is at 1 of the pattern sheet.
A is programmed.

8. Press **L**.
1 is programmed again.
9. Press **2**, and then press **-**.
The work clamp moves to the sewing start point.
10. Press **C**.
11. Input the number of stitches to be deleted, and then press **+**.
In the example, the first stitch is deleted. Press **1** **+**.

The needle point moves to A.

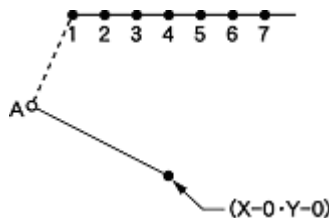

12. Carry out steps 3 and 4 of "Procedure for modifying program" to save program.

Moving the escape point

The following describes how to move the escape point from A to B.

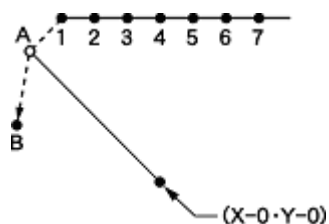

* The escape point is a provisional point provided for preventing the work clamp from interfering with the needle or the presser foot when the work clamp is lifted at the start point.

1. Carry out step 1 of "Procedure for modifying program" to call program.

2. Press **1**, and then press **+**.

The work clamp moves to the escape point.

3. Press **F**.

4. Move the work clamp with **Δ** **▽** **◀** **▶**.
Press **L** when the needle point is at point B of the pattern sheet.

B is programmed.

5. Press **1**, and then press **-**.

The needle point moves to A.

6. Press **C**.

7. Input the number of stitches to be deleted, and then press **+**.

In the example, the first stitch is deleted. Press **1** **+**.

8. The needle point moves to B.

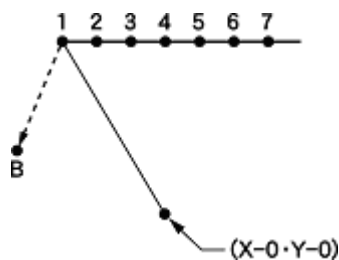

9. Carry out steps 3 and 4 of "Procedure for modifying program" to save program.

Deleting the escape point

The following describes how to delete the escape point A.

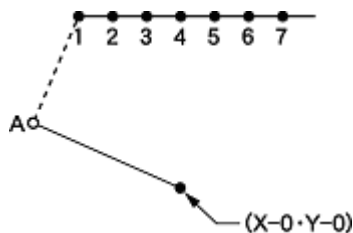

1. Carry out step 1 of "Procedure for modifying program" to call program.
2. Press **1**, and then press **+**.
The work clamp moves to the escape point.
3. Press **C**.

4. Input the number of stitches to be deleted, and then press **+**.

In the example, the first stitch is deleted. Press **1** **+**.

The needle point moves to 1.

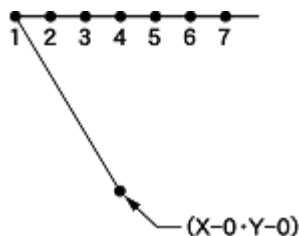

5. Carry out steps 3 and 4 of "Procedure for modifying program" to save program.

Moving the pattern in parallel (when the first stitch is the sewing start point)

The following describes how to move the pattern in parallel when the first stitch is the sewing start point.

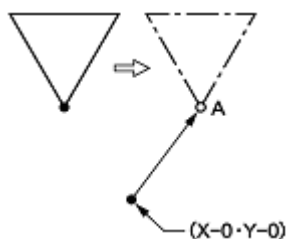

1. Carry out step 1 of "Procedure for modifying program" to call program.
2. Move the work clamp with **Δ▽◀▶**. Press **L** when the needle point is at point A of the pattern sheet.
3. Carry out steps 3 and 4 of "Procedure for modifying program" to save program.

Moving the pattern in parallel (when the first stitch is the escape point)

The following describes how to move the pattern in parallel when the first stitch is the escape point.

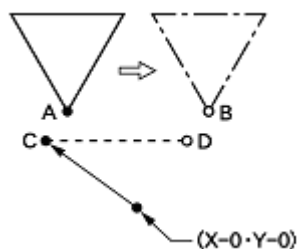

1. Carry out step 1 of "Procedure for modifying program" to call program.

2. Press **2**, and then press **+**.

The work clamp moves to point A.

3. Move the work clamp with **Δ▽◀▶** so that the needle point is at B of the pattern sheet.

Record the coordinates (values of **↔** and **↕**).
If the moving distance is long, press **F** before moving the work clamp.

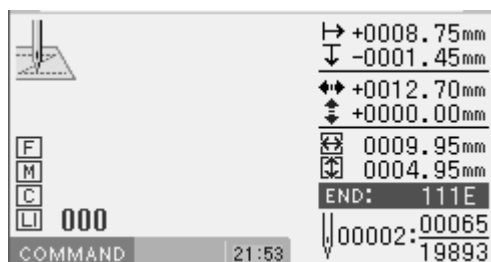

4. Press **R**.

The needle point returns to the home position.

5. Press **1**, and then press **+**.

The needle point moves to C.

6. Move the work clamp with **Δ▽◀▶** an equivalent of the coordinate value recorded in step 3.

The moved point is now D.

If the moving distance is long, press **F** before moving the work clamp.

7. Turn the pulley with a hand and put a marking with the needle to indicate the position of point D.

8. Turn the pulley with a hand and move the needle to the top point.

9. Press **R**.

The work clamp returns to the home position.

10. Move the work clamp with **Δ▽◀▶**. Press **L** when the needle point is at point D of the pattern.

11. Carry out steps 3 and 4 of "Procedure for modifying program" to save program.

Deleting a part of data during programming

The following describes how to delete 2 stitches (7 and 8) at point 8 and creating a new program.

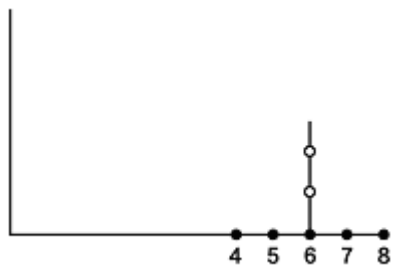

1. Press **C**.

2. Input the number of stitches to be deleted, and then press **-**.

In the example, 2 previous stitches are deleted and then press **2** **-**.

The needle point moves to 6.

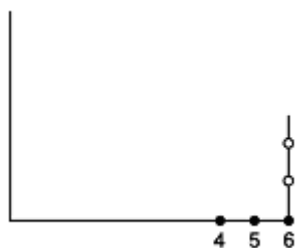

3. Continue programming.

Moving a part of continuous program in parallel

The following describes how to move patterns B and C in parallel.

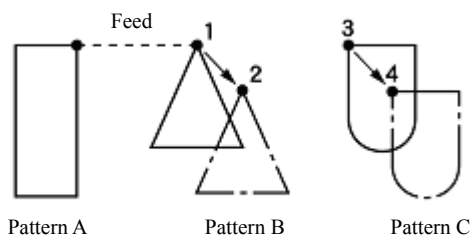

1. Carry out step 1 of "Procedure for modifying program" to call program.
2. Press **9 9 9**, and then press **+**.
The work clamp moves from the start point by each stitch.
3. When the needle point reaches 1, press **-**.
The work clamp stops. When returning the needle point, input the number of stitches to be returned and press **-**.
4. Press **7 7 7**, and then press **F**.
Input the command for parallel movement.

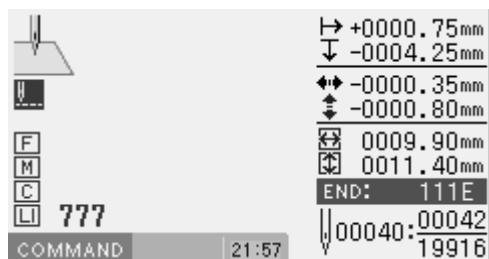

5. Move the work clamp with **Δ▽◀▶**.
Press **L** when the needle point is at 2 of the pattern sheet.

If pattern C is present after pattern B, pattern C is automatically moved in parallel. If it is inconvenient, move pattern C in parallel as in steps 1, 2, 3 and 4.

Or follow the chapter 3 "Moving a part of continuous program in parallel partially" (page 60).

6. Carry out steps 3 and 4 of "Procedure for modifying program" to save program.

Not trimming thread at the last stitch

Deleting the thread trimming code after inputting the end code can cancel thread trimming at the last stitch.

* For not trimming thread at the last stitch, you can also set the end code at "115". In this case, every thread trimming including the emergency stop is canceled. Make the following setting for canceling thread trimming at the specified point.

1. Creating program
2. Input the end code.
The work clamp returns to the first stitch.
3. Press **9 9 9 F**, and then press **+**.
The work clamp moves to the last stitch.

4. Press **1 -**.
5. Press **C**.
6. Press **1 +**.

The thread trimming code is deleted.

Programming

This section describes commands used for creating and editing program and explains how to use them.

* For details about operations, refer to "Programming example" (page 95).

Creating a line

Command to be used

<input type="text"/> <input type="text"/> <input type="text"/> LI	Input the stitch length in <input type="text"/> <input type="text"/> <input type="text"/> .
Example: Pitch	Input value
0.5 mm	005
12.0 mm	120

1. Select the sewing start point with , and then press **LI**.

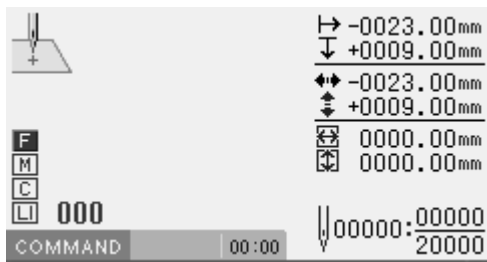

2. Input the stitch length in 3 digits, and then press **LI**.



3. Move the needle with . Press **LI**.



Creating a curve

Commands to be used

M Input the stitch length in .

Example: Pitch	Input value
0.5 mm	005
12.0 mm	120

L This command represents completing creation of a curve.

Increase the number of plotting points to create a smoother curve. One to 99 points are available for plotting.

1. Select the sewing start point with and then press **L**.

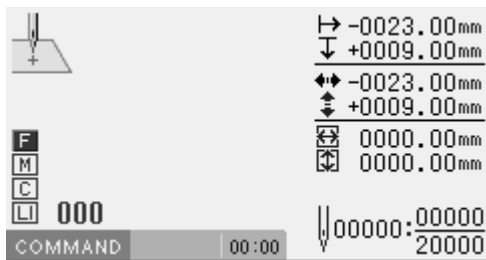

2. Input the stitch length in 3 digits, and then press **M**.



3. Move the needle with . Press **L**.



4. When the needle point is moved to the end point, press **L**.



Creating a circle



The following five commands are available for creating a circle

- | | |
|--|--|
| <input type="text"/> <input type="text"/> <input type="text"/> LI | Creating a circle by specifying 3 points on the circumference (Input the overlap stitch counts in <input type="text"/>) |
| <input type="text"/> <input type="text"/> <input type="text"/> LI | Specifying a diameter to create a clockwise circle (Input the overlap stitch counts in <input type="text"/>) |
| <input type="text"/> <input type="text"/> <input type="text"/> LI | Specifying a diameter to create a counterclockwise circle (Input the overlap stitch counts in <input type="text"/>) |
| <input type="text"/> <input type="text"/> <input type="text"/> LI | Specifying a radius to create a clockwise circle (Input the overlap stitch counts in <input type="text"/>) |
| <input type="text"/> <input type="text"/> <input type="text"/> LI | Specifying a radius to create a counterclockwise circle (Input the overlap stitch counts in <input type="text"/>) |

Input the following command to create a zigzag circle.

- M** Input this command to create a zigzag circle. Input the zigzag width in .
- The zigzag width can be specified from 1.0 to 25.5 mm. To specify the width of 10.0 mm or more, input **M** and input the width in 3 digits, then press **M**.
- | | |
|-----------------------|---|
| Example: Zigzag width | Input value |
| 3.5mm | <input type="text"/> <input type="text"/> <input type="text"/> M |
| 18.0mm | <input type="text"/> <input type="text"/> <input type="text"/> M <input type="text"/> <input type="text"/> <input type="text"/> M |

- M** Input this command to create a zigzag circle.
- Input the zigzag stitch length in .
- | | |
|----------------|-------------|
| Example: Pitch | Input value |
| 0.5mm | 005 |
| 12.0mm | 120 |

1. Select the sewing start point with , and then press .

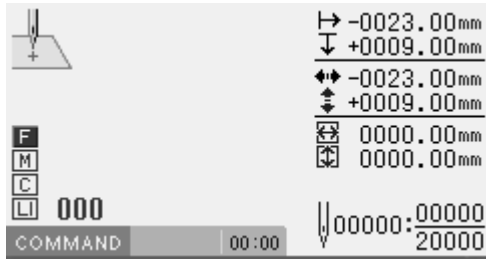

■ **Creating a circle (zigzag circle) specifying 3 points**

1. Input   .





2. Input the stitch length in 3 digits, and then press .





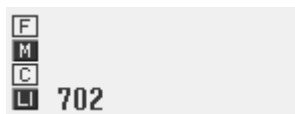

Creating a zigzag circle (skip to step 5 when not creating a zigzag circle)

3. Input   (width).



4. Input the zigzag stitch length in 3 digits, and then press .



5. Move the needle with  to select the second point. Press .
6. Move the needle with  to select the third point. Press .

■ **Creating a circle (zigzag circle) by specifying the diameter**

1. Input    (clockwise) or    (counterclockwise).



2. Input the stitch length in 3 digits, and then press .



Creating a zigzag circle (skip to step 5 when not creating a zigzag circle)

3. Input   (width).



4. Input the zigzag stitch length in 3 digits, and then press .



5. Move the needle with  to select the second point. Press .

■ **Creating a circle (zigzag circle) by specifying the radius**

1. Input **2** **3** **LI** (clockwise) or **2** **4** **LI** (counterclockwise).

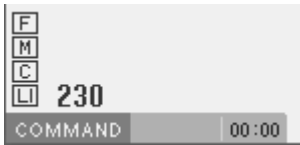

2. Input the stitch length in 3 digits, and then press **LI**.



Creating a zigzag circle (skip to step 5 when not creating a zigzag circle)

3. Input **7** **M** (width).



4. Input the zigzag stitch length in 3 digits, and then press **M**.



5. Move the needle with **Δ** **▽** **◀** **▶** to select the second point. Press **L**.

Creating an arc

Command to be used



Creating an arc passing 3 points

1. Select the sewing start point with **Δ** **▽** **◀** **▶**, and then press **L**.

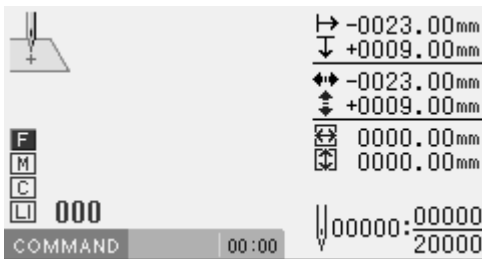

2. Input **3** **0** **0** **LI**.



3. Input the stitch length in 3 digits, and then press **LI**.



4. Move the needle with **Δ** **▽** **◀** **▶** to select the second point. Press **L**.

5. Move the needle with **Δ** **▽** **◀** **▶** to select the third point. Press **L**.

Creating a semicircle

Commands to be used

3 1 0 L	Creating a clockwise semicircle
3 2 0 L	Creating a counterclockwise semicircle

1. Select the sewing start point with , and then press **L**.

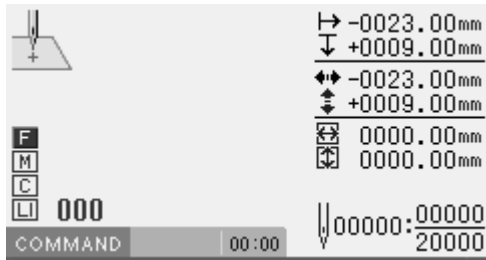

2. Input **3** **1** **0** **L** (clockwise) or **3** **2** **0** **L** (counterclockwise).



3. Input the stitch length in 3 digits, and then press **L**.



4. Move the needle with  to select the second point. Press **L**.

Creating a zigzag stitch

Commands to be used

7 <input type="text"/> <input type="text"/> M	Creating a zigzag width. Input the zigzag width in <input type="text"/> <input type="text"/> See “Creating a circle”(page 121)
<input type="text"/> <input type="text"/> <input type="text"/> M	Creating a zigzag width. Input the zigzag stitch length in <input type="text"/> <input type="text"/> <input type="text"/> See “Creating a circle”(page 121)
7 8 9 L	Carrying out zigzag stitch symmetrically to the sewing path
7 8 8 L	Carrying out zigzag stitch on the left of the sewing path
7 8 7 L	Carrying out zigzag stitch on the right of the sewing path

1. Select the sewing start point with , and then press **L**.

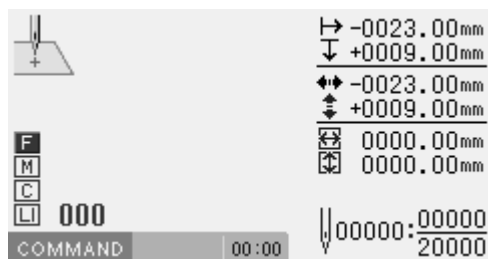

2. Input **7** **M** (width).



3. Input the zigzag stitch length in 3 digits, and then press **M**.



4. Move the needle with  to select the second point. Press **L**.

5. Input **7** **8** **9** **L** at the end position of the needle.

Input **7** **8** **8** **L** for creating on the left of the sewing path and **8** **7** **L** for creating on the right of the sewing path.



■ Modifying the program of a multiple stitch

When modifying the stitch length or the number of lines for a multiple stitch, the previously created curve program can be used.

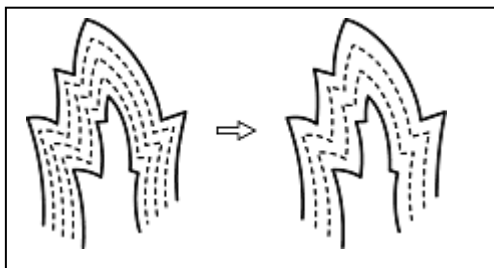

The previously created programs are required for modifying programs of multiple stitch.

Programs of multiple stitch written to a media cannot be modified.

Commands to be used

5 <input type="text"/> <input type="text"/> M	Input the number of lines for a multiple stitch in <input type="text"/> <input type="text"/> . The specifiable number of lines is 2 to 99.
5 lines	Input value 505
<input type="text"/> <input type="text"/> <input type="text"/> M	Input the stitch length in <input type="text"/> <input type="text"/> <input type="text"/> .

1. Press **R**.

The work clamp moves to the home position.

2. Input **9 9 9 +**.

The needle point moves. When the needle point is at the start point for a multiple stitch, stop it by pressing **-**.

3. Input the desired number of lines as **5** M.



4. Input the desired stitch length as M.



5. Press **L**.

Calculation is performed based on the input data. When the calculation ends, the needle point moves to the end point for a multiple stitch.

Creating a parallel stitch

Commands to be used

3 <input type="text"/> <input type="text"/> M	Creating parallel stitch in the same direction to the sewing path. Input the width of parallel stitch in <input type="text"/> <input type="text"/> . Values 1.0 to 9.9 mm are available for the width. Example: Width Input value 1.5 mm 315
<input type="text"/> <input type="text"/> <input type="text"/> M	Input the stitch length in <input type="text"/> <input type="text"/> <input type="text"/> .
7 8 9 L	Carrying out parallel stitch on the left of the sewing path
7 8 8 L	Carrying out parallel stitch on the right of the sewing path
1 1 <input type="text"/> E	Starting parallel stitch calculations (This is the code to end programming. For details, refer to page 133.)

1. Select the sewing start point with , and then press **L**.

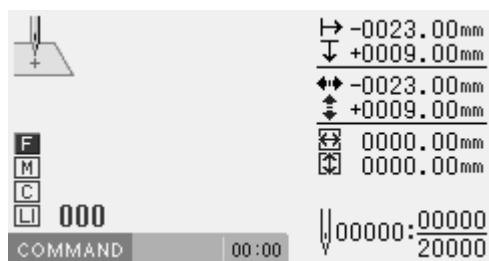

2. Input the stitch width, and then press **3** **M**.



3. Move the needle point to the second point or after with . Press **L**.

4. Move the needle to the corner point and input **7** **8** **L**.

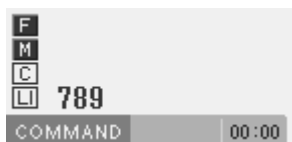

5. Repeat steps 3 and 4 and move the needle to the end point. Then input **1** **1** **E**.

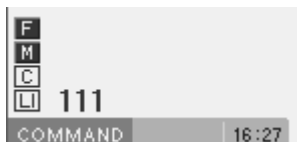

When the calculation is complete, the needle point moves to the end position.

Creating an offset

Commands to be used

(4) () () (M)	Creating an offset. Input the width of offset stitch in () (). Values 1.0 to 9.9 mm are available for the width Example: Width Input value 1.5 mm 415
() () () (M)	Input the stitch length in () () ().
(7) (8) (9) (L)	Carrying out offset on the left of the sewing path
(7) (8) (8) (L)	Carrying out offset on the right of the sewing path
(1) (1) () (E)	Starting offset calculations (This is the code to end programming. For details, refer to page 133.)

1. Select the sewing start point with and then press (L).

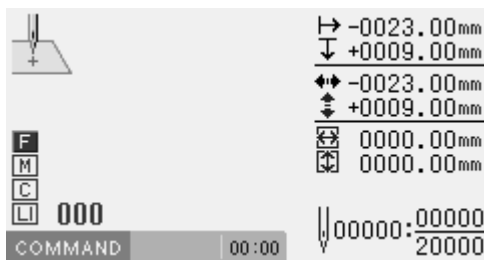

2. Input the stitch width, and then press (4) () (M).



3. Move the needle point to the second point or after with . Press (L).

4. When the needle point is moved to the corner, press (7) (8) () (L).

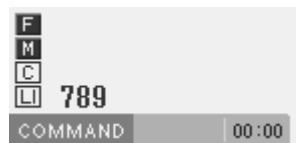

5. Repeat steps 3 and 4 and move the needle to the end point. Then input (1) (1) () (E).

When the calculation is complete, the needle point moves to the end position.



Creating feed data

Commands to be used

(F) (6) (6) (6) (L)	Specifying split (the separation point for different patterns in sewing) after feed
(F) (7) (7) (7) (L)	Moving in parallel for the feed
(F) (8) (8) (8) (L)	Creating split data after basting
(F) (9) (9) (9) (L)	Creating basting data

* To cancel basting, input (9) (9) (0) (L) at the basting position.

1. Press (F).
2. Determine the feed point with .

3. Input command depending on the feed.
If not specified, press (L).

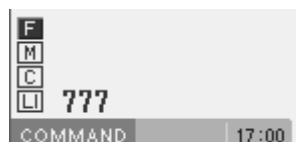

Creating split data

Commands to be used

2	2	0	L	Stopping the needle at the upper end for the split
2	2	1	L	Stopping the needle at the lower end for the split

1. Input command depending on the split.

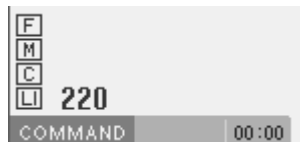

Creating magnified data

Commands to be used

9	0	2	M	Magnified input ($\times 2$)
9	0	5	M	Magnified input ($\times 5$)
9	1	0	M	Magnified input ($\times 10$)

The following three scales are available for magnification: $\times 2$, $\times 5$, and $\times 10$.

Use a pattern sheet suitable for the magnified pattern.

The magnified data is reduced when the end code is input.

1. Make sure that the needle point is at the home position.

When returning the needle point to the home position, press **R**.

2. Select magnification, and then press **9** **M**.



3. Create pattern data.

Move the needle with **Δ** **▽** **<** **>**. Press **L**.

4. Input the end code.

Low-speed sewing

Make setting for low-speed sewing.

Commands to be used

6 6 6 L	The maximum sewing speed is set at 400 rpm or lower.
6 6 7 L	The maximum sewing speed is set at 1200 rpm or lower.
6 6 8 L	The maximum sewing speed is set at 800 rpm or lower.
6 6 9 L	The maximum sewing speed is set at 600 rpm or lower.
6 6 0 L	Canceling low speed data setting

1. Move the needle to the position you want to apply the command at.

For moving the needle position, refer to "Description of commands" (page 90).

2. Select the type of low speed sewing and input the command.

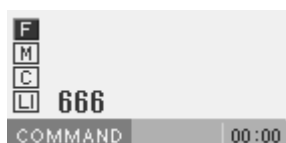

Setting the option output

This is set to flip/flop the option output.

Commands to be used

7 7 1 L	Flipping/flopping option output 1
7 7 2 L	Flipping/flopping option output 2
7 7 3 L	Flipping/flopping option output 3
7 7 0 L	Canceling option output setting

1. Move the needle to the position you want to apply the command at.

For moving the needle position, refer to "Description of commands" (page 90).

2. Input the command for option output.

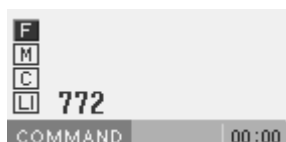

Setting the height of presser foot

The height of the presser foot is changed.

Command to be used

9 [] [] L	Input the height of the presser foot in [] []. Height values of 0 to 99 are available for input. Inputting 0 0 cancels setting for the height of presser foot
-------------	---

1. Input the height of the presser foot.

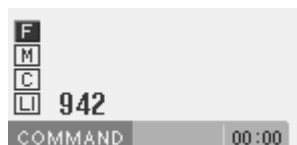

Ending programming

When programming is completed, input the end code.

Commands to be used

1	1	1	E	Normal end
1	1	2	E	Normal end
1	1	3	E	Carrying out no thread wiping
1	1	4	E	Setting the sewing speed at 1200 rpm or lower without thread wiping
1	1	5	E	Carrying out no thread trimming
1	1	6	E	Fixing the sewing speed at 1500 rpm or lower

1. When the program has been created, input the end code.

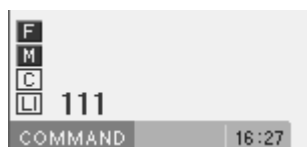

Data after the end code is input is deleted.

Edit the retrieved or created program.

The following options are available as editing functions.

0 0 1 M	Moving a pattern symmetrically to the Y-axis
0 1 0 M	Moving a pattern symmetrically to the X-axis
0 1 1 M	Moving a pattern symmetrically to a point
6 6 6 M	Rotating a pattern clockwise
6 6 7 M	Rotating a pattern counterclockwise
6 7 6 M	Copying a rotated pattern clockwise
6 7 7 M	Copying a rotated pattern counterclockwise
8 8 8 M	Resizing a pattern (Input the magnification in the X direction in <input type="text"/> <input type="text"/> <input type="text"/> F, and input the magnification in the Y direction in <input type="text"/> <input type="text"/> <input type="text"/> M.)
9 9 9 M	Copying a resized pattern (Input the magnification in the X direction in <input type="text"/> <input type="text"/> <input type="text"/> F, and input the magnification in the Y direction in <input type="text"/> <input type="text"/> <input type="text"/> M.)
3 3 3 L	Repeated copying
4 4 0 L	Copying a pattern symmetrically to a point
4 4 1 L	Copying a pattern symmetrically to the X-axis
4 4 2 L	Copying a pattern symmetrically to the Y-axis
4 4 3 L	Copying in the reverse direction
7 7 7 L	Moving data in parallel from the current needle position (changing the moving amount of the data for the needle position)
LI 7 7 7 L	Moving data in parallel from the current needle position (using needle drop data to the moved position)

Moving a pattern symmetrically to the Y-axis

Command to be used

0 0 1 M	Moving a pattern symmetrically to the Y-axis passing the start point of sewing
---------	--

This function is available only when the needle point is at the home position.

1. Make sure that the needle point is at the home position.

Press **R** if the needle is not at the home position.

2. Input **0 0 1 M**.



3. Press **L**.



Moving a pattern symmetrically to the X-axis

Command to be used

0 1 0 M

Moving a pattern symmetrically to the X-axis passing the start point of sewing

This function is available only when the needle point is at the home position.

1. Make sure that the needle point is at the home position.

Press **R** if the needle is not at the home position.

2. Input **0 1 0 M**.



3. Press **L**.



Moving a pattern symmetrically to a point

Command to be used

0 1 1 M

Moving a pattern symmetrically to the sewing start point

This function is available only when the needle point is at the home position.

1. Make sure that the needle point is at the home position.

Press **R** if the needle is not at the home position.

2. Input **0 1 1 M**.

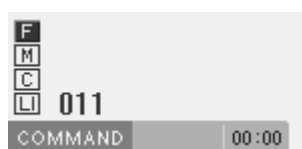

3. Press **L**.

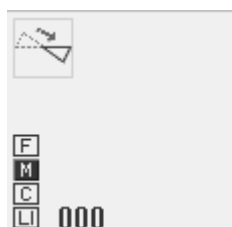

Rotating a pattern clockwise (counterclockwise)

Commands to be used

6	6	6	M	Rotating clockwise
6	6	7	M	Rotating counterclockwise

This function is available only when the needle point is at the home position.

Values of 1 to 359 degrees are available for input.

1. Make sure that the needle point is at the home position.

Press **R** if the needle is not at the home position.

2. Determine the center point for rotation with **△▽◀▶**.

3. Input **6 6 6 M** or **6 6 7 M**.

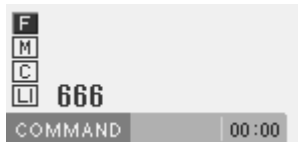

4. Input the angle in 3 digits, and then press **L**.



Copying a rotated pattern rotated clockwise (counterclockwise)

Commands to be used

6	7	6	M	Copying a rotated pattern rotated clockwise
6	7	7	M	Copying a rotated pattern rotated counterclockwise

This function is available only when the needle point is at the home position.

Values of 1 to 359 degrees are available for input.

The copied data is linked to the original data with a split data.

1. Make sure that the needle point is at the home position.

Press **R** if the needle is not at the home position.

2. Determine the center point for rotation with **△▽◀▶**.

3. Input **6 7 6 M** or **6 7 7 M**.

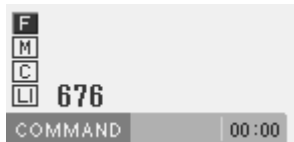

4. Input the angle in 3 digits, and then press **L**.

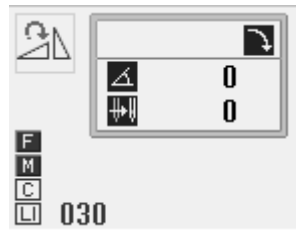

Resizing a pattern

Commands to be used

8 8 8 M	Resizing a pattern in the X and Y directions
F	Used to input magnification in the X direction
M	Used to input magnification in the Y direction

This function is available only when the needle point is at the home position.

1. Make sure that the needle point is at the home position.

Press **R** if the needle is not at the home position.

2. Determine the reference point for resizing with **△▽◀▶**.

3. Input **8 8 8 M**.

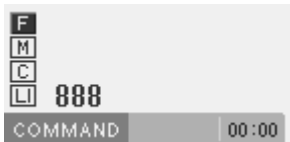

4. Input the magnification in 3 digits in the X direction, and then press **F**.

Magnification values of 0 to 400 are available for input.

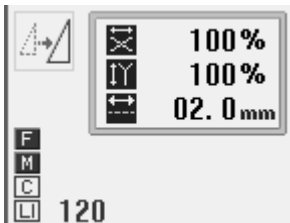

5. Input the magnification in 3 digits in the Y direction, and then press **M**.

Magnification values of 0 to 400 are available for input.

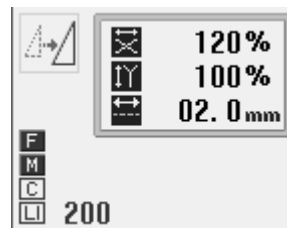

6. Input the stitch length in 3 digits, and then press **L**.

If the value is "000", the stitch count will be unchanged. The stitch length increases or decreases.

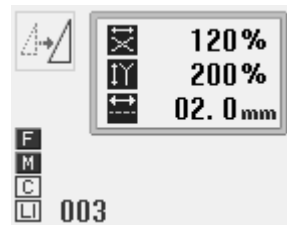

Copying a pattern resized

Commands to be used

9 9 9 M	Copying a pattern resized in the X and Y directions
○ ○ ○ F	Used to input magnification in the X direction.
○ ○ ○ M	Used to input magnification in the Y direction.

This function is available only when the needle point is at the home position.

The copied data is linked to the original data with a split data.

1. Make sure that the needle point is at the home position.

Press **R** if the needle is not at the home position.

2. Determine the reference point for resizing with .

3. Input **9 9 9 M**.

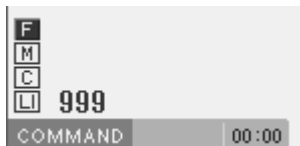

4. Input the magnification in 3 digits in the X direction, and then press **F**.

Magnification values of 0 to 400 are available for input.

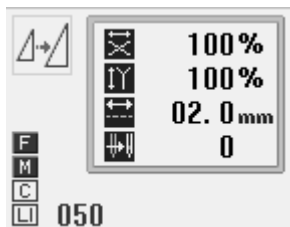

5. Input the magnification in 3 digits in the Y direction, and then press **M**.

Magnification values of 0 to 400 are available for input.

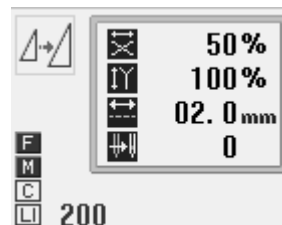

6. Input the stitch length in 3 digits, and then press **L**.

If the value is "000", the stitch count will be unchanged. The stitch length increases or decreases.

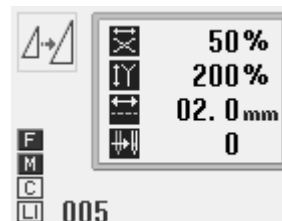

Repeated copying

Command to be used

3 3 3 L

Copying data, from the sewing start point or the feed point (excluding the number of feed boundaries to be ignored) to the current needle position, to the area after the current needle position

1. Move the needle to the position you want to apply the command at.

For moving the needle position, refer to "Description of commands" (page 90).

2. Input **3 3 3 L**.

The needle follows the copied data. Press **-** to stop the needle halfway.

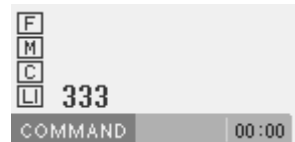

Copying a pattern symmetrically to a point

Command to be used

4 4 0 L

Copying data, from the start point or the feed point (excluding the number of feed boundaries to be ignored) to the current needle position, symmetrically to the current needle position

1. Move to the desired needle position you want to apply the command at.

For moving the needle position, refer to "Description of commands" (page 90).

2. Input **4 4 0 L**.



Copying a pattern symmetrically to the X-axis

Commands to be used

4 4 1 L

Copying data, from the start point or the feed point (excluding the number of feed boundaries to be ignored) to the current needle position, symmetrically to the X-axis based on the current needle position

1. Move the needle to the position you want to apply the command at.

For moving the needle position, refer to "Description of commands" (page 90).

2. Input **4 4 1 L**.



Copying a pattern symmetrically to the Y-axis

Commands to be used

4 4 2 L

Copying data, from the start point or the feed point (excluding the number of feed boundaries to be ignored) to the current needle position, symmetrically to the Y-axis based on the current needle position

1. Move the needle to the position you want to apply the command at.

For moving the needle position, refer to "Description of commands" (page 90).

2. Input **4 4 2 L**.



Turnover

Command to be used

4 4 3 L

Copying data in the reverse direction from the start point or the feed point (excluding the number of feed boundaries to be ignored) to the current needle position

1. Move the needle to the position you want to apply the command at.

For moving the needle position, refer to "Description of commands" (page 90).

2. Input **4 4 3 L**.

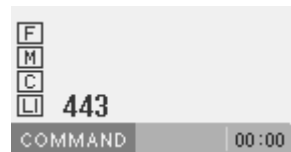

Moving in parallel

Commands to be used

7 7 7 L

Changing the moving amount of the data for the current needle position

LI 7 7 7 L

Moving data in parallel from the current needle position (using needle drop data to the moved position)

1. Move the needle to the position you want to apply the command at.

For moving the needle position, refer to "Description of commands" (page 90).

2. Input **7 7 7 L** or **LI 7 7 7 L**.



3. Determine the moving destination point with **ΔΔΔΔ**, and then press **L**.

Deleting data being created/edited

Delete data being created or edited.

Deleting a part of data

Commands to be used



Deletes data after stitches

If this command is used at the sewing start point, the sewing start point is deleted and the current needle position becomes the sewing start point



Deletes data before stitches

If this command is used at the sewing end position, the end code is deleted

1. Move the needle to the position you want to apply the command at.

For moving the needle position, refer to "Description of commands" (page 90).

2. Input the command.



Input to delete data after the current needle position.

Input to delete data before the current needle position.

Input the stitch count in .

Deleting program data

1. Press .



The input data is deleted.

Checking the program setting and setting attribute

1. Move the needle to a desired data position for changing attributes.

For moving the needle position, refer to "Description of commands" (page 90).

Refer to Chapter 3 "Programming with Icons" (page 21).

Chapter 5

Extended Option Output

Function of the extended option output

You can register programs to control various pressing motions and automatic stacking of sewn products in the sewing machine for any purpose.

- * Data for an old model (BAS300E/F series) is available on a sewing machine of BAS300G series; however, the reverse is not possible.
- * Operation for the extended option output is for the experienced. Since it includes complicated operations, you are recommended to receive training before using this function. For information on the training, contact an engineer who have received training or store where you purchased your sewing machine.

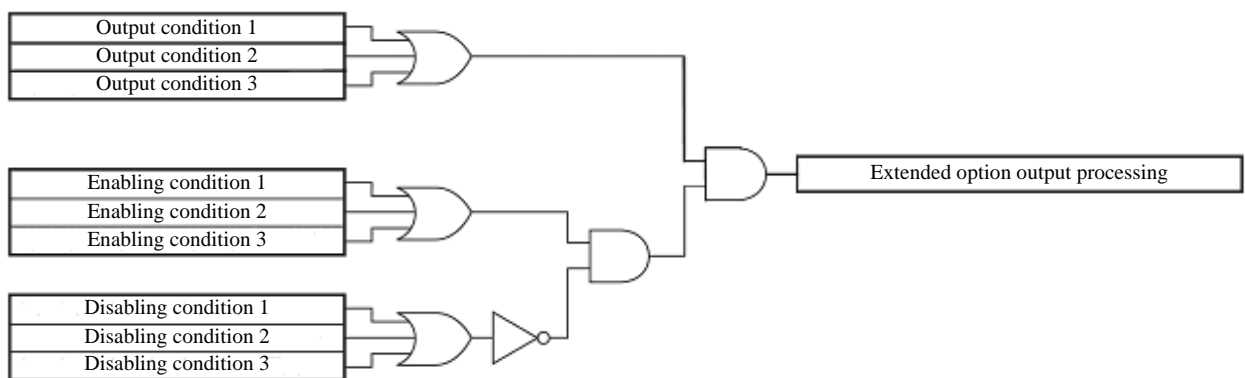

Only when 3 conditions, i.e. output conditions, enabling conditions and disabling conditions (three items for each), are established, the extended option output is executed.

The relationship between the output and the conditions is as follows:





Opening the extended option output setting screen

The extended option setting screen is displayed following the procedure below.

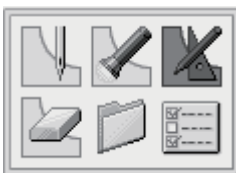
1. Select , and then press .



2. Select , and then press .



The extended option output setting screen opens.



Items which can be set in the extended option output

Carrying out operations below in the extended option output setting menu.



Setting details of the extended option output
⇒ See page 147



Setting enabling conditions
⇒ See page 148



Reading the extended option output data saved in the media.
⇒ See page 148



Saving the extended option output data in the sewing machine or a different medium.
⇒ See page 149



Deleting the extended option output data being edited or saved in the media.
⇒ See page 149



Setting details of the extended option output

Specifying a value at the items below.



Extended option output No.:

Specify any output number between 1 and 20 with the numeric keys.

⇒ See “Table of extended option output” (page 153).



Operation setting:

Select ON, OFF, or F/F (FLIP and FLOP) with .



Output conditions:

Input conditions for the extended option output. 3 conditions can be specified.

⇒ See “Table of extended option output” (page 153).



Timer 1:

Set a time until the output is switched after the output condition is established.

Set 0 or any value between 10 and 2550 ms by increments of 10 ms.



Timer 2:

Set duration of the extended option output.

Set 0 or any value between 10 and 2550 ms by increments of 10 ms. If you set 0, the switched output status is kept.

When setting has been completed, be sure to press .

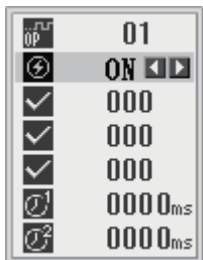

* To cancel the set value, input , and then press .

* When registering the set conditions (saving them in the FLASH ROM incorporated in the sewing machine)
⇒ See “Saving the extended option output data” (page 149).



Setting enabling conditions

Setting enabling conditions below.



Extended option output No.:

Specify any output number between 1 and 20 with the numeric keys.

⇒ See “Table of extended option output” (page 153).



Enabling conditions:

3 conditions can be specified.

⇒ See “Table of condition number” (page 150)



Disabling conditions:





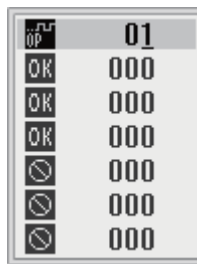

3 conditions can be specified.

⇒ See “Table of condition number” (page 150).

* If enabling conditions are not set, it is always in the enabled status. To use the extended option output conditions without changing any, do not set any value as enabling conditions.

When setting has been completed, be sure to press .



To cancel the set value, input    at  or , and then press .





Reading the extended option output data

Reading the extended option output data saved in the media (the FLASH ROM incorporated in the sewing machine, CompactFlash inserted into the sewing machine, and floppy disk).

1. Load a medium holding data you want to read.

Load a medium before turning on the power.

* When reading data saved in the FLASH ROM incorporated in the sewing machine or programmer, this step is not required.

2. Select , and then press .



3. Select a medium holding data you want to read, and then press .

The data is read and you are returned to the extended option output setting screen.





Saving the extended option output data

Saving the extended option output data created by the programmer in the media and register it in the sewing machine (the FLASH ROM incorporated the sewing machine).

* At the same time as saving the extended option output data in the CompactFlash of the sewing machine, it is also saved in the FLASH ROM of the sewing machine.

1. Load a medium on which you want to save the data.

Load a medium before turning on the power.

2. Select , and then press .



3. Select a medium to save the data, and then press .

The data is written and you are returned to the extended option output setting screen.



Deleting the extended option output data

Deleting the extended option output data being edited or saved in the media.

1. Load a medium from which you want to delete the data.

Load a medium before turning on the power.

* When deleting the data saved in the FLASH ROM incorporated in the sewing machine or programmer, this step is not required.

2. Select , and then .



The confirmation screen appears.

3. Press .

The data is deleted and you are returned to the extended option output setting screen.

Deleting the data in the FLASH ROM incorporated in the sewing machine will delete the data stored in the sewing machine.

Table of condition number

The following shows the output condition numbers, enabling condition numbers and disabling condition numbers, and operations to establish them.

Mode for operating the sewing machine

Condition No.	Operation to establish the condition
1	After a feed is complete at the home position
2	After a feed is complete at the sewing start point (at escape point, if applicable)
3	Before sewing or a test feed starts from the sewing start point (or the escape point)
4	Before the upper shaft of the sewing machine starts rotating at the first stitch
5	Before a test feed starts at the first stitch
6	After sewing or a test is complete (before moving to the sewing start or escape point)
7	After an emergency stop is reset
8	After a step back starts
9	Before halfway sewing starts
10	After the lower thread counter value changes from 1 to 0 and the lower thread replacement wait state starts.
11	After the lower thread replacement wait state ends
12	After a program starts
13	After a program ends
14	When trigger data is detected during sewing
15	After an emergency stop occurs
16	After a thread breakage is detected
17	After a program is changed
18	After the power switch is turned on
19	After a low air pressure error is detected
20	Before moving to the next start point on completion of sewing in the split mode
21	After moving to the next start point on completion of sewing in the split mode

Standard input

Condition No.	Operation to establish the condition
25	When the foot pedal is enabled (before the work clamp moves up or down)
26	When the start pedal is enabled (before starting operation)

Standard output

Condition No.	Operation to establish the condition
30	After the work clamp rises (after the right work clamp rises for the air type)
31	After the work clamp lowers
32	After the left work clamp rises (only for the air type)
33	After the left work clamp lowers (only for the air type)
34	After the intermittent work clamp rises
35	After the intermittent work clamp lowers
36	After the wiper output is turned off
37	After the thread breaking output is turned off
38	Before the work clamp rises

External input of the extended option

Condition No.	Operation to establish the condition
40	When extended option input 1 is turned on
41	When extended option input 1 is turned off
42	When extended option input 2 is turned on
43	When extended option input 2 is turned off
44	When extended option input 3 is turned on
45	When extended option input 3 is turned off
46	When extended option input 4 is turned on
47	When extended option input 4 is turned off
48	When extended option input 5 is turned on
49	When extended option input 5 is turned off
50	When extended option input 6 is turned on
51	When extended option input 6 is turned off
52	When extended option input 7 is turned on
53	When extended option input 7 is turned off
54	When extended option input 8 is turned on
55	When extended option input 8 is turned off
56	When extended option input 9 is turned on
57	When extended option input 9 is turned off
58	When extended option input 10 is turned on
59	When extended option input 10 is turned off
60	When extended option input 11 is turned on
61	When extended option input 11 is turned off
62	When extended option input 12 is turned on
63	When extended option input 12 is turned off
64	When extended option input 13 is turned on
65	When extended option input 13 is turned off
66	When extended option input 14 is turned on
67	When extended option input 14 is turned off

Extended option output

Condition No.	Operation to establish the condition
70	When extended option output 1 is turned on
71	When extended option output 1 is turned off
72	When extended option output 2 is turned on
73	When extended option output 2 is turned off
74	When extended option output 3 is turned on
75	When extended option output 3 is turned off
76	When extended option output 4 is turned on
77	When extended option output 4 is turned off
78	When extended option output 5 is turned on
79	When extended option output 5 is turned off
80	When extended option output 6 is turned on
81	When extended option output 6 is turned off
82	When extended option output 7 is turned on
83	When extended option output 7 is turned off
84	When extended option output 8 is turned on
85	When extended option output 8 is turned off
86	When extended option output 9 is turned on
87	When extended option output 9 is turned off
88	When extended option output 10 is turned on
89	When extended option output 10 is turned off
90	When extended option output 11 is turned on
91	When extended option output 11 is turned off
92	When extended option output 12 is turned on
93	When extended option output 12 is turned off
94	When extended option output 13 is turned on
95	When extended option output 13 is turned off
96	When extended option output 14 is turned on
97	When extended option output 14 is turned off
98	When extended option output 15 is turned on
99	When extended option output 15 is turned off
100	When extended option output 16 is turned on
101	When extended option output 16 is turned off
102	When extended option output 17 is turned on
103	When extended option output 17 is turned off
104	When extended option output 18 is turned on
105	When extended option output 18 is turned off
106	When extended option output 19 is turned on
107	When extended option output 19 is turned off
108	When extended option output 20 is turned on
109	When extended option output 20 is turned off

Table of extended option input

Extended option input No.	Combined output (condition) *1		Connector *2			
	Name	Use condition	Connector No.	Pin No.		
				Signal	+24V	OV
1	EJECT RIGHT SENSOR	MEMORY SW560=1,2	P23 (EXIN1)	2	3	1
2	EJECT LEFT SENSOR	MEMORY SW560=1,2		5	6	4
3				8	9	7
4				11	12	10
5				14	15	13
6	Pno input bit0	MEMORY SW354=1,2	P24 (EXIN2)	2	3	1
7	Pno input bit1	MEMORY SW354=1,2		5	6	4
8	Pno input bit2	MEMORY SW354=1,2		8	9	7
9	Pno input bit3	MEMORY SW354=1,2		11	12	10
10	Pno input bit4	MEMORY SW354=1,2		14	15	13
11	THREAD CATCH F SENSOR	MEMORY SW500 ON	P10 (SENSOR2)	2	1	3
12	THREAD CATCH R SENSOR	MEMORY SW500 ON		5	4	6
13	AIR SW	MEMORY SW558 ON	P12 (AIR1)	12	11	9
14			P8 (SENSOR1)	11	10	12

***1: Use this output when an optional part is mounted.**

It is not available as the extended option I/O if conditions are established.

***2: Connector numbers and pin numbers on the control board in the control box**

Table of extended option output

Extended option output No.	Combined output (condition) *1		Connector *2			
	Name	Use condition	Connector No.	Pin No.		
				Signal	+24V	
1	2-STEP THREAD TENSION DEVICE	MEMORY SW563 ON	P12 (AIR1)	5	10 11	
2	AIR WIPER	MEMORY SW557=2		6		
3	AUTO EJECT	MEMORY SW560=1,2,3		7		
4	RIGHT WORK CLAMP FLIP/FLOP	MEMORY SW055 ON	P25 (AIR2)	1	9 10	
		Pno output bit0		MEMORY SW951 ON		
5	LEFT WORK CLAMP FLIP/FLOP	MEMORY SW055 ON		2		
		Pno output bit1		MEMORY SW951 ON		
6		Pno output bit2		MEMORY SW951 ON		3
7		Pno output bit3		MEMORY SW951 ON		4
8				5		
9	SIGNAL TOWER GREEN	MEMORY SW559 ON		6		
10	SIGNAL TOWER YELLOW	MEMORY SW559 ON		7		
11	SIGNAL TOWER RED	MEMORY SW559 ON		8		
12	NEEDLE COOLER	MEMORY SW550 ON		P12 (AIR1)		8
13	INNER CLAMPING DEVICE	MEMORY SW556=1,2,3	4			
14			3			
15	LCLAMP	When 2 stage work clamp is used	2			
16	RCLAMP	For the air type	1			
17						
18			P26 (AIR3)	1	5	
19				2		
20				3		
				4		

***1: Use this output when an optional part is mounted.**

It is not available as the extended option I/O if conditions are established.

***2: Connector numbers and pin numbers on the control board in the control box**

Examples of the extended option output

To program the extended option output, prepare the timing chart. Then, set output conditions and enabling/disabling conditions based on the chart.

The following examples describe how to develop program setting values based on the timing chart.

* No explanation of the operation of the sewing machine is provided.

■ Example 1

Sequence 1 for stacker

This sequence ejects material immediately after the work clamp rises on completion of sewing, and programs stacking operation.

Option output 4	BAR1: For holding material
Option output 5	BAR2: For moving material
Option output 6	AIR: For air blow

Timing chart

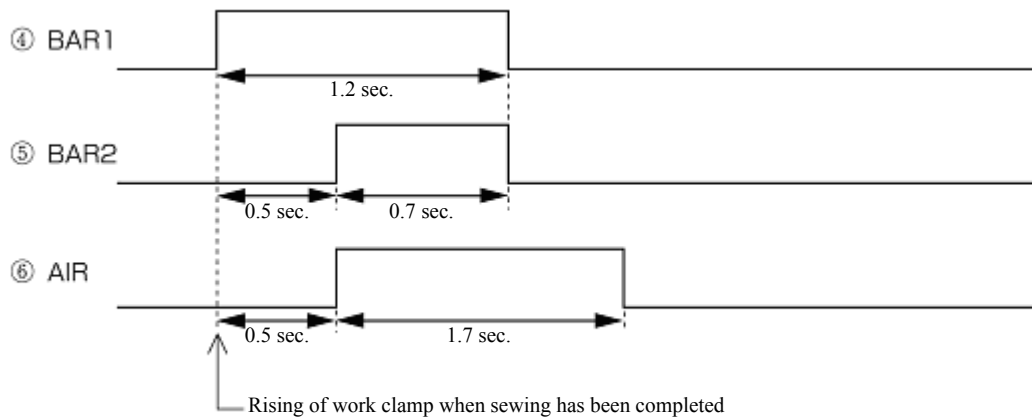

Program setting values

Output No.	Operation setting	Output condition		Timer 1 [ms]	Timer 2 [ms]	Enabling conditions <input checked="" type="checkbox"/>		Disabling conditions <input type="checkbox"/>	
		Condition No.	Content			Condition No.	Content	Condition No.	Content
4	ON	30	Rising of work clamp	0	1200	6	End of sewing	81	Output 6 OFF
5	ON	76	Output 4 ON	500	700	–	–	–	–
6	ON	76	Output 4 ON	500	1700	–	–	–	–

■ Example 2

Sequence 2 for stacker

This sequence ejects material immediately after the work clamp rises on completion of sewing, and programs stacking operation.

Option output 3	UP/DW: Rising/lowering for removing material
Option output 4	MOVE: Movement for removing material
Option output 5	BAR1: For holding material
Option output 6	BAR2: For moving material

Timing chart

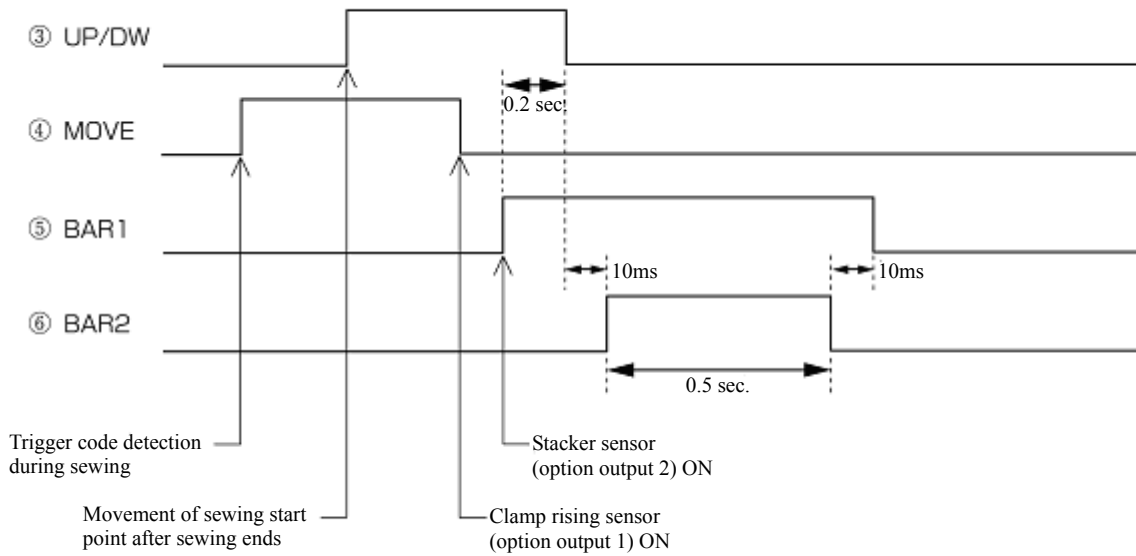

Program setting values

Output No.	Operation setting	Output condition		Timer 1 [ms]	Timer 2 [ms]	Enabling conditions <input checked="" type="checkbox"/>		Disabling conditions <input type="checkbox"/>	
		Condition No.	Content			Condition No.	Content	Condition No.	Content
3	ON	2	Movement of sewing start point	0	0	6	End of sewing	1	Sewing machine returns to home position
	OFF	78	Output 5 ON	200	0				
4	ON	14	Trigger detection	0	0	-	-	-	-
	OFF	40	Input 1 ON	0	0				
5	ON	42	Input 2 ON	0	0	-	-	-	-
	OFF	78	Output 6 OFF	10	0				
6	ON	75	Output 3 OFF	10	500	-	-	-	-

■ Example 3

Signals for external equipment

When connecting to the external sequence unit, this sequence programs operations to issue timing signals.

Option output 4	READY: Ready-for-sewing signal
Option output 5	END: Sewing end signal
Option output 6	THBK: Thread breakage detection signal

Timing chart

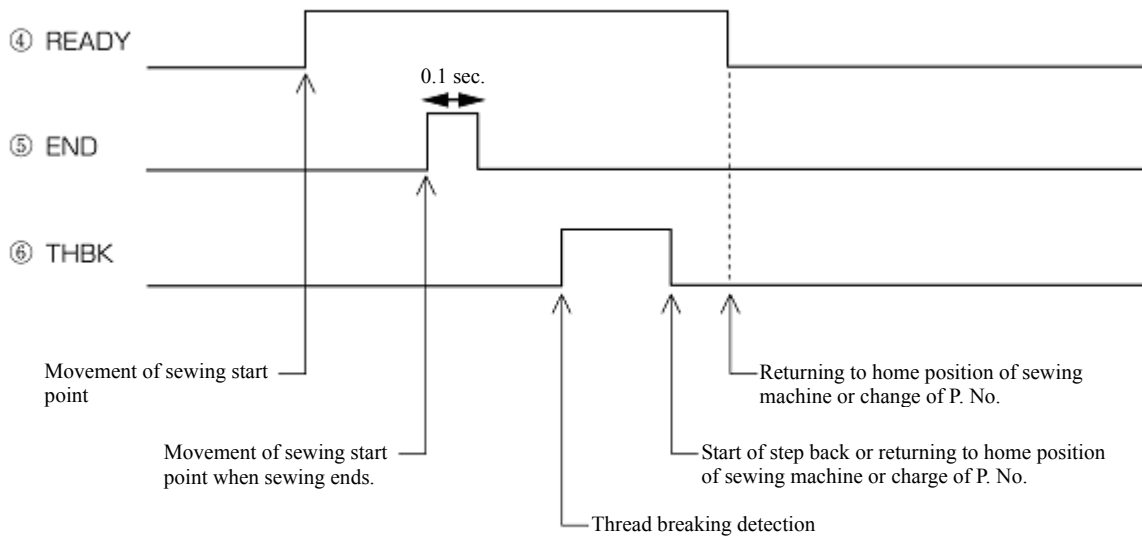

Program setting values

Output No.	Operation setting	Output condition		Timer 1 [ms]	Timer 2 [ms]	Enabling conditions <input checked="" type="checkbox"/>		Disabling conditions <input type="checkbox"/>	
		Condition No.	Content			Condition No.	Content	Condition No.	Content
4	ON	2	Movement of sewing start point	0	0	-	-	-	-
	OFF	1	Sewing machine returns to home position	0	0				
		17	Change of P. No.						
5	ON	2	Movement of sewing start point	0	100	6	End of sewing	1	Sewing machine returns to home position
6	ON	16	Thread breakage detection	0	0	-	-	-	-
	OFF	8	Start of step back	0	0				
		77	Output 4 OFF						

Use of extended option output (Basics)

This section provides a comprehensive description of how to use the extended option output by providing a range of examples so that many users will be able to use it easily.

The examples show programs that can be tried and tested only with an air-type sewing machine.

Necessary items

Air work clamp type sewing machine (an electromagnetic type is not applicable).

The programmer

CF card

Programming instruction manual (See the instruction manual when a reference page is provided.)

Sewing machine adjustment manual (See the section on switching the memory switch.).

Simplified examples of the extended option output

Programming No. 1 to No. 20 is possible as option outputs; No. 15 is for the air valve output of the left work clamp and No. 16 is for the air valve output of the right work clamp. If outputs No. 15 and 16 are programmed as option output, the work clamp will not function as originally programmed, but will function as programmed as option output. The examples show how to program option outputs No. 15 and 16 to confirm their operation (acceptable if the left and right work clamps function as programmed).

Caution

One example shows how to sew with the work clamp raised. Please be careful when attempting it.

Be sure to remove the needle before confirming its operation.



■ Turning the output interlocking on and off corresponding to sewing machine operations

Create a program to automatically raise and lower the left work clamp (option output No. 15 ON and OFF) at the sewing start point.

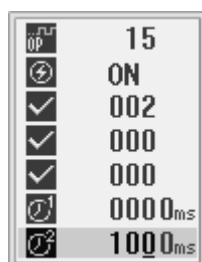

1. Load the CF card into the CF slot of the sewing machine. Turn on the sewing machine.
2. Have the programmer at hand. Display the output setting screen according to the extended option output operation (see page 146).
3. Referring to the table of sewing machine operation mode condition numbers (see page 150), set "ON when condition No. 2 (on completion of movement to the sewing start point) is established". Set Timer 2 to 1 sec. (1000 ms). On the setting screen, make the following settings.





After inputting values, press  to confirm the settings.

To confirm that the selected values were correctly input, move the cursor to . Press the  key once to select No. 16. Press the  key to return to No. 15.

4. Press .

5. Select , and then press .



6. Select , and then press .



7. Press  to turn the programmer light off. Turn off the power then turn it back on again.

Initial settings are carried out at power-on; after writing extended option outputs, turn off the power once. (In this case, carry out initial settings so that output No. 15 does not function as the left work clamp, but functions as the extended option.)

8. Read short sewing data of approximately 10 stitches. Set the memory switch No. 50 to 4 (the work clamp is not are automatically raised when sewing is completed). Carry out sewing operation.

Confirm that the left work clamp is in the raised position, that it stays in that position for one second, and then lowers whenever the needle returns to the sewing start point. If the left work clamp operates in this manner, it is operating in accordance with the program.

■ Modifying programmed data

Modify existing program data according to the procedure described in "Turning the output interlocking on and off corresponding to sewing machine operations".

In most cases, only one option program can be stored on one CF card. (It has file name is [ISMSEQ00.SEQ].)

1. Confirm that the CF card written to in accordance with the procedure described in "Turning the output interlocking on and off corresponding to sewing machine operations" is loaded. Display the extended option output home screen (shown below).

2. Read the written data by using .



3. Display the output setting screen. Set Timer 1 to 0.5 sec. (500 ms) and Timer 2 to 0.5 sec. (500 ms). On the setting screen, make the following settings.



Move the cursor to the set value [1000] at Timer 2. Write [0500] over it.

- Following the same procedure as outlined in steps 4 and 5 of "Turning the output interlocking on and off corresponding to sewing machine operations", write the option program over the program on the CF card. Press  to turn the programmer light off. Turn off the power then turn it back on again.



- Carry out sewing operation. Confirm that the time that elapses after the needle returns to the sewing start point until the left work clamp rises is longer (since the setting for Timer 1 has been changed from 0 to 0.5 sec.), and that the length of time the work clamp takes to rise is less (since the setting for Timer 2 has been changed from 1 to 0.5 sec.).

■ Individually programming on and off

In the examples of "Turning the output interlocking on and off corresponding to sewing machine operations" and "Modifying data you programmed once", a procedure was described outlining how to create a program to keep the output on state for a time set for Timer 2, and return it to the off state automatically.

In this example, create a program to automatically open the left work clamp at the sewing start point (option output No. 15 ON) and close it simultaneously when the machine starts. (option output NO. 15 OFF). Confirm that on and off output conditions are different.

- Have the programmer at hand. Display the output setting screen.



- Referring to the table of sewing machine operation mode condition numbers (see page 150), set "ON when condition No. 2 is established (on completion of movement to the sewing start point)". On the setting screen, make the following settings.

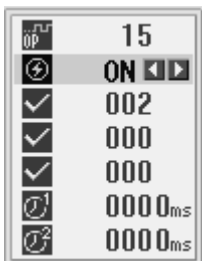

- Move the cursor to [ON]. Press the + key. Every time the + key is pressed switches among ON, OFF and F/F. Set it to [OFF]. Referring to the table of condition numbers (see page 150), set "OFF when condition No. 3 (before commencing sewing) is established". On the setting screen, make the following settings.

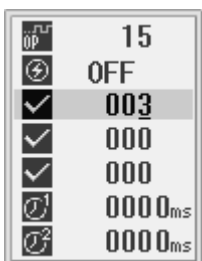

- Write the option program over the program on the sewing machine CF card. Press  to turn the programmer light off. Turn off the power then turn it back on again.

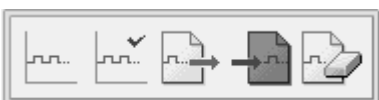

- Carry out sewing operation. Confirm that the left work clamp rises after the needle returns to the sewing start point and it lowers when sewing begins.

As shown in the above example, when Timer 2 is set to [00], the on or off state will remain unchanged after the condition is established.

■ Using trigger data to turn the output on while sewing

In the "Individually programming on and off" example, No. 15 was programmed to be turned on at the sewing start point. However, in this example, change the setting so that No. 15 is turned on while sewing. Do not change the off condition setting, "OFF when sewing starts", which was set for "Individually programming output on and off".

- Read the written data by using .



- Referring to the table of sewing machine operation mode condition numbers (see page 150), set "ON when condition No. 14 (trigger data detection) is established". On the setting screen, overwrite the values as follows.

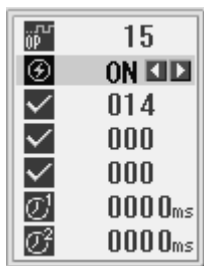

Move the cursor to [ON]. Press the - key. The value is switched to OFF. Confirm that the data set in the previous section remains.

- Write the option program over the program on the CF card. Press  to turn the programmer light off.



- Press the P key of the programmer again to read and edit the sewing data. Input trigger data at any position. (See page 76.) On the trigger data screen, set option output No. 15 and sewing machine pausepage OFF. On the setting screen, make the following settings.



- Store the sewing data as a new program number after inputting the trigger data. Press  to turn the programmer light off. Turn off the power then turn it back on again.

Carry out sewing operation. Confirm that the left work clamp rises at the position where you input the trigger data and that it lowers when sewing begins.

■ Sequence output

Create an example to carry out sequence output after the work clamp rises when sewing ends under the assumption that this option output is for the stacker (a device that ejects material after sewing is complete).

Make settings so that option output No. 15 is turned on and off corresponding with the raising of the work clamp and option output No. 16 is turned on and off. In the next section, add a sewing end condition.

1. Have the programmer at hand. Display the output setting screen.
2. Referring to the table of condition numbers of the standard output (see page 150), set output condition No. 15 to "ON when condition No. 30 is established (after the work clamp rises)". Set Timer 2 to 1.2 sec. (1200 ms). On the setting screen, make the following settings.



3. Referring to the table of condition numbers of the extended option output (see page xxx), set the output condition for No. 16 to "condition No. 98 (when No. 15 is turned on)". Set Timer 1 to 0.5 sec. (500 ms) and Timer 2 to 0.7 sec. (700 ms). On the setting screen, make the following settings.



4. Write the option program over the program on the CF card of the sewing machine. Press  to turn the programmer light off. Turn off the power then turn it back on again.



5. Set the memory switch No. 50 to 3 (the work clamps are automatically raised when sewing is completed) to carry out sewing operation. Confirm that the left work clamp (No. 15) is turned on and right work clamp (No. 16) is turned on after a 0.5 sec. delay and both are turned off in 0.7 sec. corresponding with the raising of the work clamps (in this example, the right and left work clamps operate as option outputs). Depress the foot pedal to confirm that No. 15 and 16 are turned on and off. When restarting, confirm that the intermittent clamp is at the lowered position.

In the sequence output mode (outputs are sequentially turned on and off), specify sewing machine operation as the condition of the output to be turned on first, and then specify "when the first output is turned on or off" as the condition for the subsequent outputs. This method is very handy.

■ **Adding enabling (AND) conditions to the sequence output**



In the example in the previous section, option outputs No. 15 and 16 are turned on and off even when you depress the foot pedal. In this section, add enabling conditions to allow the output to be turned on and off only when sewing is finished.



1. Read the written data by using .



2. On the extended option output home screen, press  to display the enabling condition setting screen.



3. Referring to the table of condition numbers of the sewing machine operation mode (see page 150), set enabling condition No. 15 to "Enabling  when condition No. 6 (after sewing ends) is established". Set it to "Disabling  (condition No. 101 according to the table of condition number on page 151) when output No. 16, which ends output of a series of sequence, is turned off is established)."



OP	15
OK	006
OK	000
OK	000
	101
	000
	000

4. Write the option program over the program on the sewing machine CF card. Press  to turn the programmer light off. Turn off the power then turn it back on again.

If an enabling condition has been set, this output is disabled immediately after power-on as initial setting.



5. Read sewing data to carry out sewing operation. Confirm that the left and right work clamps (option outputs No. 15 and 16) do not operate when the foot pedal is depressed, but they are turned on and off corresponding with the raising of the work clamps when sewing is completed. (Confirm that the intermittent clamp is at the lowered position. Depress the start switch.)

If you set "enabling  as the enabling condition", you usually need to set "disabling  as well.

In the above example, set an enabling (AND) condition at the output No. to be turned on and off first, and as a disabling condition, set the condition number to "when the last sequence is turned on and off".

If you do not set any enabling conditions as in the previous examples, outputs are turned on and off according to the settings made on the output setting screen.

Copying already created option output data

You can produce copies of option output data between sewing machines not using the programmer, but by using the CF card instead.

Referring to the sewing machine adjustment manual, carry out the data read/write mode [r11] operation on the copy destination sewing machine.

Deleting extended option output data from the sewing machine

1. Have the programmer at hand. Display the extended option output home screen (shown below) according to the operation of the extended option output (see page 146).

2. Delete the extended option output data from the sewing machine by using .



3. Press  to turn the programmer light off. Turn off the power then turn it back on again. Read sewing data to carry out sewing operation. Confirm that the extended option output data has been deleted.

The extended option output data remains on the CF card. To register it again, carry out the data read/write mode [r11] operation on the sewing machine.

As an alternative to deleting the extended option output data, you can use one of the operations for clearing data stored in the sewing machine: deleting the extended option output data or deleting all stored data.

Use of extended option output (Application)

On the precondition that a checking board is created, this section describes how to create programs by providing some examples.

Necessary items (other than for Basics)

Checking board (See "Reference material".)

Limitations of extended option output

- Disabled when an output point count exceeds 20 (including the work clamp output).
- Disabled when an input point count exceeds 14.
- Input check during sewing machine operation is disabled. Therefore, on and off operation of the output detected by input from the foot switch pedal while sewing is not possible.
- Sequence output during sewing machine operation is disabled.

On and off operation of the output by inputting trigger data out of sewing data is enabled.

Temporarily pausing the sewing machine to run the extended option output by inputting trigger data is enabled. (Input and output are enabled in this case.)

- Disabled when many AND conditions are set. For example, operation by switching among multiple modes and inhibition of output by combining multiple inputs are disabled. Settings of 2-input AND conditions per option output are enabled; configuration of 3-input AND conditions is enabled by setting one output as a virtual output. (See "Examples of option outputs".)
- Control of the incorporated stepper motor output by the extended option output is disabled.

Examples of option outputs (Application)

■ Automating the commencement of sewing

If you set memory switch No. 950 to ON, sewing automatically commences after turning on option output No. 1. Create a program to make the machine commence sewing after the work clamp lowers.

1. Set memory switch No. 950 to ON.
2. Have the programmer at hand. Display the output setting screen.
If any registered option program already exists, delete it using the delete icon. Turn the programmer back on.
3. Referring to the table of condition numbers of the standard output (see page 150), set the output condition for No. 1 to "ON when condition No. 31 (after the work clamp lowers) is established". Set Timer 2 to 100 ms. On the setting screen, make the following settings.



- Write the option program over the program on the sewing machine CF card. Press  to turn the programmer light off. Turn off the power then turn it back on again.





- Read the sewing data. Depress the start pedal. The sewing machine detects the home position and moves to the sewing start point. Though depressing the start pedal usually starts sewing operation, it will not when memory switch No. 950 is set to ON. Depress the foot pedal twice to raise and lower the work clamp. Confirm that sewing commences after the foot pedal has reached the lowered position.

■ Controlling commencement of sewing by providing an input check to the automatic start function

Add option input No. 1 to the enabling conditions in the previous section.

- Read the written data by using the CF card read icon.



- Display the enabling condition setting screen. Referring to the table of external input condition numbers (see page 150), set enabling condition No. 1 to “enabling  when condition No. 40 (input 1 ON) is established”. Set “disabling  when condition No. 41 (input 1 OFF) is established”.

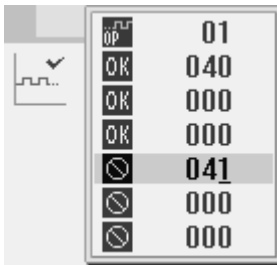

- Write the option program over the program on the sewing machine CF card. Press  to turn the programmer light off. Turn off the power then turn it back on again.



- Other than the conditions in the previous section, confirm also that sewing commences only when option input No. 1 is set to ON.

By carrying out sequence control of the raising and lowering of the work clamp using the option output in the example above, you can configure the sewing machine so that material is automatically loaded before sewing.

■ Adding input check to carry out settings of 3-input AND conditions

Add "when option inputs No. 1 and 2 are ON" to the enabling conditions in the previous section. As an output condition, "after the work clamp lowered (condition No. 31)" has been set; 3-input AND conditions in total are set. Settings of 2-input AND conditions per option output are enabled; configure 3-input AND conditions by setting one output as virtual output. In this case, set option output No. 2 as virtual output.

- Read the written data by using the CF card read icon.



2. Display the enabling condition setting screen. Referring to the table of extended option output condition numbers (see page 151), set enabling condition No. 1 to “enabling when condition No. 72 (output 2 ON is established.” Set “disabling when condition No. 73 (output 2 OFF) is established”.

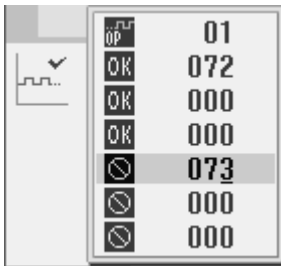

3. Referring to the table of external input condition numbers (see page 151), set "ON when condition No. 40 (input 1 ON) is established" as the output condition for No. 2 ON. On the setting screen, make the following settings.

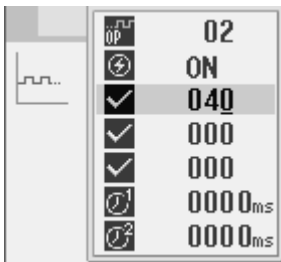

4. Referring to the table of external input condition numbers (see page 151), set "OFF when condition No. 41 (input 1 OFF) is established" as the output condition for No. 2 OFF. On the setting screen, make the following settings.

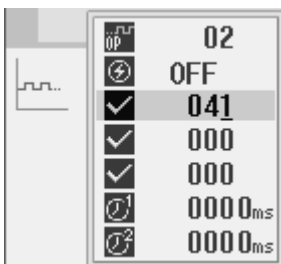

5. Referring to the table of external input condition numbers (see page 151), set “enabling when condition No. 42 (input 1 ON) is established” as the enabling condition for No. 2. Set “disabling when condition No. 43 (input 2 OFF) is established”.

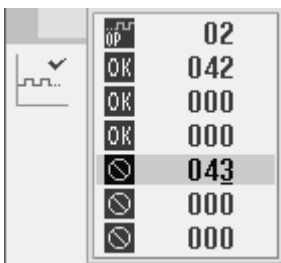

6. Write the option program over the program on the sewing machine CF card. Press to turn the programmer light off. Turn off the power then turn it back on again.



7. Confirm that sewing commences as the work clamp lowers when both option inputs No. 1 and 2 are ON.

In the example above, the output condition for virtual output No. 2 ON is condition No. 40 (input 1 ON). If input 1 is already on at power-on, virtual output No. 2 will not be activated.

■ Temporary pause during sequence operation

Program Example 1 from the instruction manual. Confirm the option output during temporary pause.

1. Delete the registered option program using . Turn off the programmer then turn it back on.
2. Referring to Example 1 (Sequence 1 for the stacker) in the programmer instruction manual (see page 154), program outputs of No. 4, 5, and 6 and enabling conditions for No. 4.
3. After confirming that the sewing machine can be operated as programmed, press the temporary pause switch during the sequence operation to cancel it.

Operating temporary pause during sequence operation temporarily pauses the sequence. To complete the sequence, carry out a restore operation.

4. Add condition No. 15 (when the sewing machine enters the temporary pause state), as conditions for output No. 4, 5, and 6 OFF.

If you press the temporary pause switch, the output is immediately turned off.

How to create programs

■ Selecting hardware on the output side

Use NPN open collector outputs.

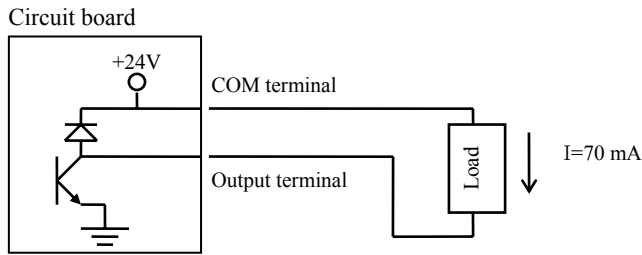

It is assumed that an optionally available air valve is used.

In addition to a 24 V air valve, use a 24 VDC relay.

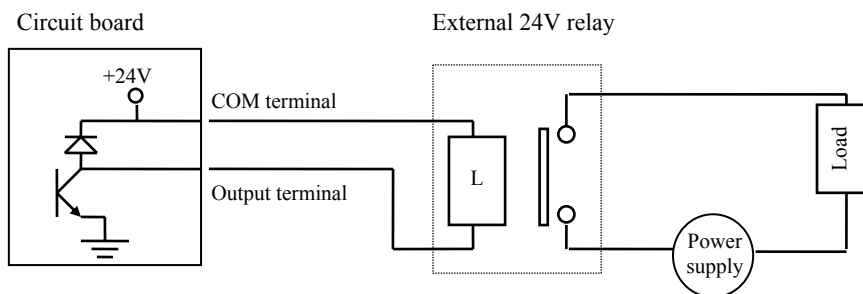

Fuses are not incorporated into the output circuit. To prevent the circuit from being damaged if the output short-circuits, it is recommended that you mount an external fuse for each circuit.

■ Selecting hardware on the input side

- Use non-isolated IC inputs.

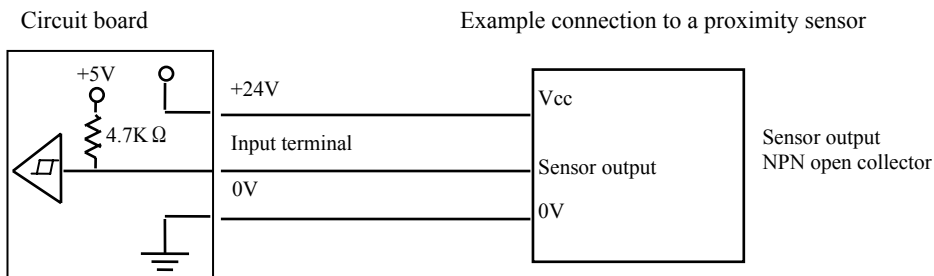

- In addition to using a contact switch or a 24 V sensor, use relays to isolate inputs.

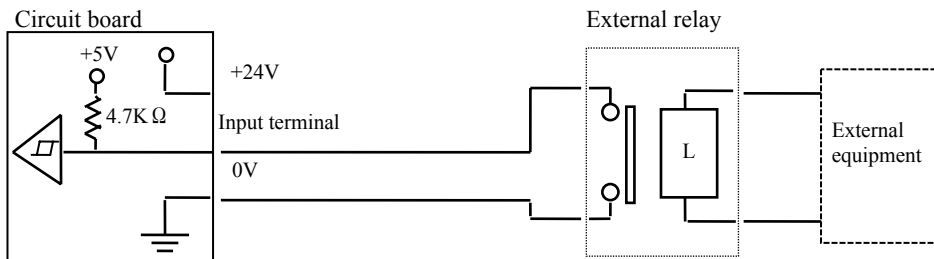

- Use relays for an electronic circuit with a min. application load of 5 V and 1 mA or less.

■ **Creating an I/O allocation table**

Allocate the selected hardware to complete the table.

Table of option output

Option output No.	Allocation		Connector		
	Name	Description	Connector No.	Pin No.	
				Signal	+24V
1			P12 (AIR1)	5	10 11
2				6	
3					
4			P25 (AIR2)	1	9 10
5				2	
6				3	
7				4	
8				5	
9				6	
10				7	
11				8	
12			P12 (AIR1)	8	10 11
13				4	
14				3	
15				2	
16				1	
17			P26 (AIR3)	1	5
18				2	
19				3	
20				4	

Table of option input

Option input No.	Allocation		Connector			
	Name	Description	Connector No.	Pin No.		
				Signal	+24V	0V
1			P23 (EXIN1)	2	3	1
2				5	6	4
3				8	9	7
4				11	12	10
5				14	15	13
6				P24 (EXIN2)	2	3
7			5		6	4
8			8		9	7
9			11		12	10
10			14		15	13
11			P10 (SENSOR2)	2	1	3
12				5	4	6
13			P12 (AIR1)	12	11	9
14			P8 (SENSOR1)	11	10	12

■ Creating a timing chart and table of program setting values

See three examples in pages 154 to 156.

1. Create a timing chart where on and off operations of input and output are shown in sequence of order of operation.
2. Tabulate the program setting values based on the timing chart and table of condition numbers (see pages on 150).
3. Input values by using the programmer.

Use of extended option output (Reference material)

Appendix

Parts for the extended option

- P12 AIR1 connector
For option outputs 1 to 3 and 12 to 16
For option input 13
12-pin connector of NH series from J.S.T. Mfg Co., Ltd.
- Housing for P25 AIR 2 connector
For option output 4 to 11
10-pin housing of NH series from J.S.T. Mfg Co., Ltd.
- Housing for P26 AIR 3 connector
For option output 17 to 20
5-pin housing of NH series from J.S.T. Mfg Co., Ltd.

Parts for the extended option input

- Housing and pin for P23 EXIN 1 connector
Option input 1 to 5
16-pin housing of PHD series from J.S.T. Mfg Co., Ltd.
- Housing and pin for P24 EXIN 2 connector
Option input 6 to 10
18-pin housing of PHD series from J.S.T. Mfg Co., Ltd.
- Housing and pin for P10 SENSOR 2 connector
Option input 11 to 12
6-pin housing of PH series from J.S.T. Mfg Co., Ltd.
- Housing and pin for P8 SENSOR 1 connector
Option input 14
12-pin housing of XAD series from J.S.T. Mfg Co., Ltd.

Circuit diagram of the checking board

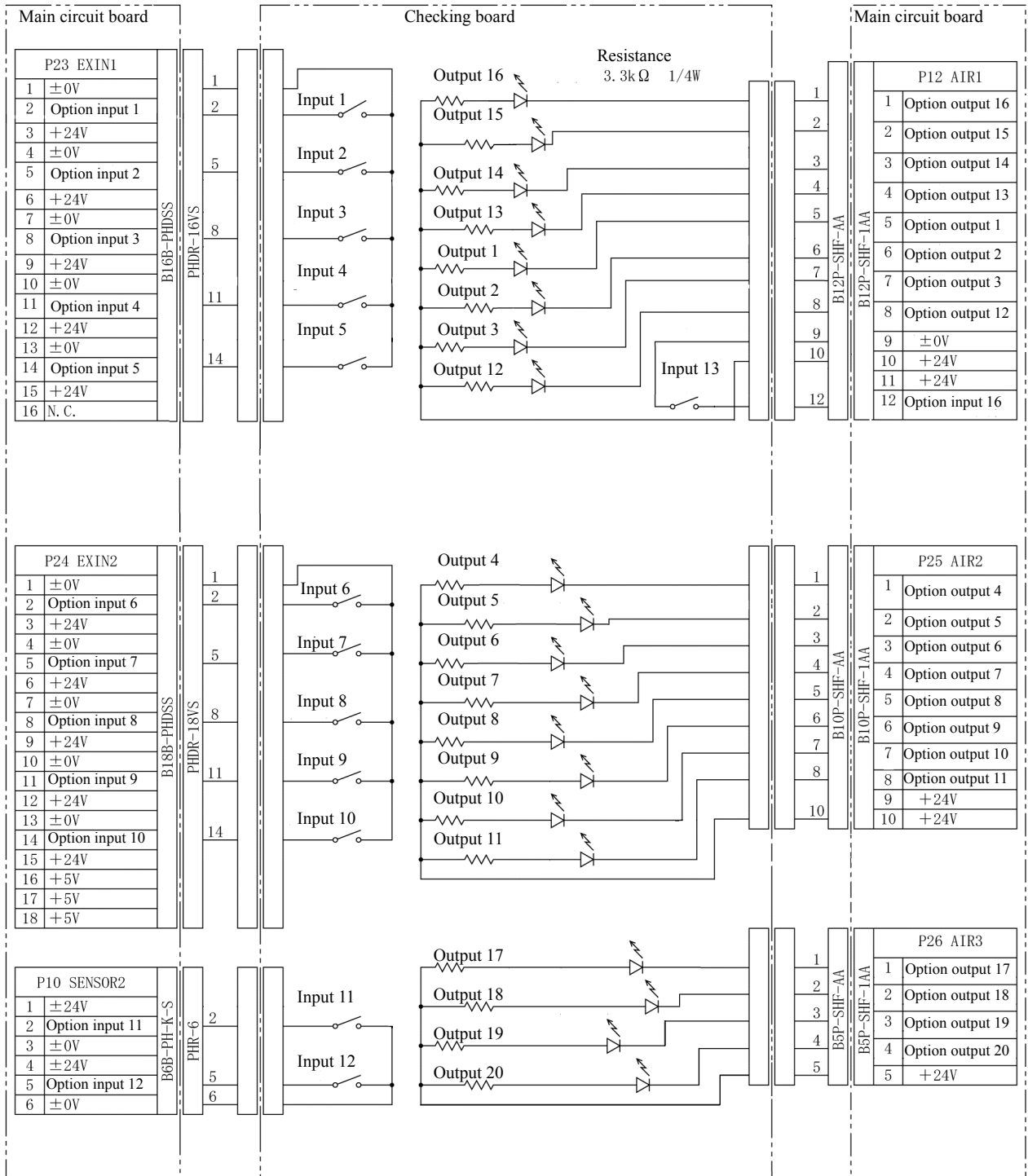

Option input 14 is a connector shared with the home position sensor signal. It is not used on the checking board.

Block diagram

Connector layout of the main circuit board

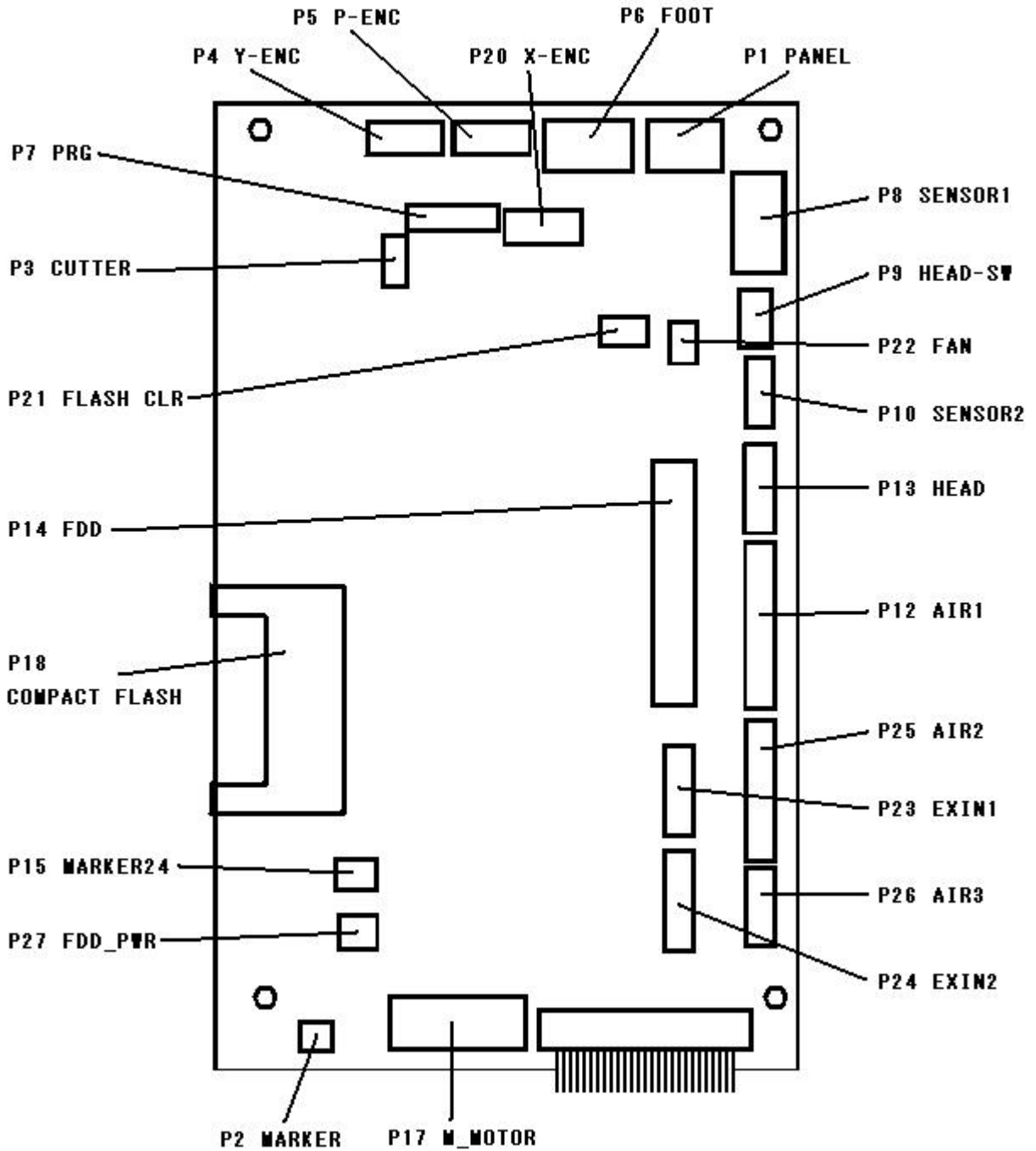



Chapter 6

Reading/Saving/Deleting Program and Formatting Media

Procedures for reading/saving/deleting program and formatting media

This section describes how to read, save and delete program, and format media.

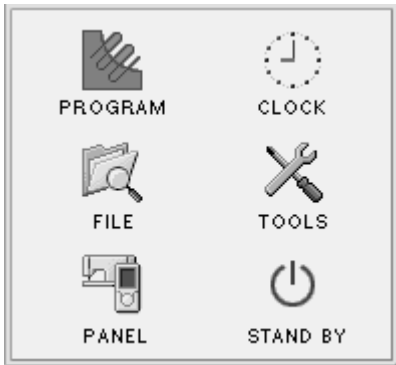

1. Press .

2. Select  by using . Press .

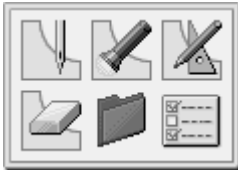

3. Select  by using . Press .



4. Select an icon depending on your purpose on the screen displayed in step 3 by using . Press . For more information, see “Reading program” (page 175), “Saving program” (page 178), “Deleting program” (page 179), and “Formatting media” (page 181).

Reading program



Reading program

Read program from media.

When no program is being created, you can also read program by pressing the R/W button on the operation panel.

This operation is not available in command mode.

You can also read program created by BAS-300, BAS-300A and BAS-300E series.

1. Execute steps 1 to 3 of "Procedures for reading/saving/deleting program and formatting media".

2. Confirm that  is selected. Press .



3. Input a program number to select by using the numeric keys. Press .

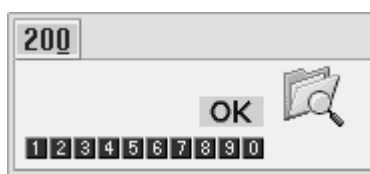

4. Select **OK**. Press .

To display the program list, select .

Also, the read destination can be changed.

(See "Switching between media" (page 186).)



Reading additional program

Select this function when you want to read different program sequentially after reading program.

Additionally read program is added to the program being edited as split data.

This operation is not available in command mode.

You can also read program created by BAS-300, BAS-300A and BAS-300E series.

1. Execute steps 1 to 3 of "Procedures for reading/saving/deleting program and formatting media".

2. Confirm that  is selected. Press .

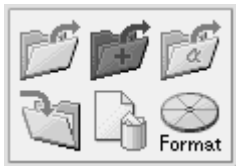

3. Input a program number to select by using the numeric keys. Press .

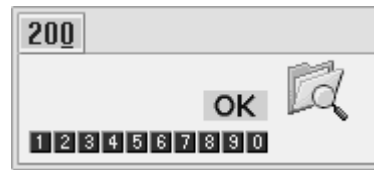

4. Select **OK**. Press .

To display the program list, select .

Also, the read destination can be changed.

(See "Switching between media" (page 186).)



Reading program in a different format

Read program created in a different sewing machine.

Program in the following three formats can be read.



DST

DSB



DSZ

This operation is not available in command mode.

1. Execute steps 1 to 3 of "Procedures for reading/saving/deleting program and formatting media".

2. Confirm that  is selected. Press .



3. Select program to read by using , and then press .

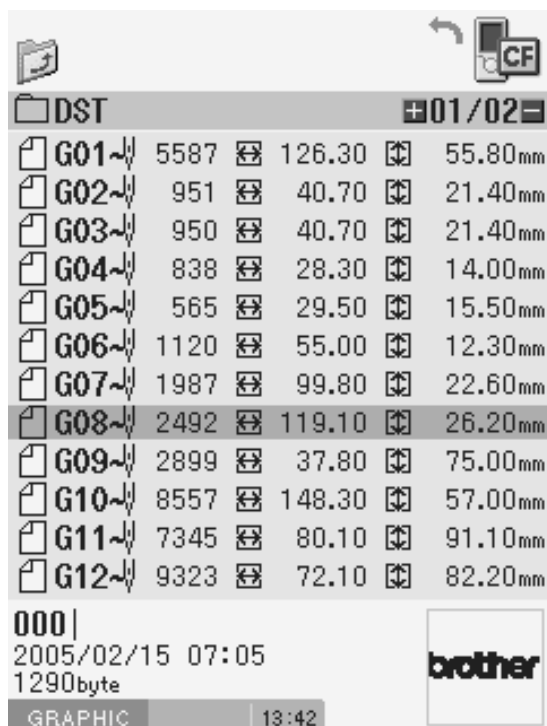

When checking program by displaying its image (skip to step 5 when not checking program)

4. Press .

To return to the previous screen, press .

5. Select program to read by using .

6. Press .

If the image is displayed, press  again to read program.

To cancel reading, press .



An screen example when the image is display

Saving program



Saving program

Write program in the programmer onto a medium.

When program is being created, you can also read program by pressing the R/W button on the operation panel.

This operation is not available in command mode.





1. Execute step 1 to 3 of "Procedures for reading/saving/deleting program and formatting media".

2. Confirm that  is selected. Press .







3. Input a program number. Press .



4. Input a comment by selecting characters using    . Press .



5. Select **OK** by using    . Press .



To display the program list, select .

Also, the read destination can be changed.

(See "Switching between media" (page 186).)

Deleting program



Deleting program saved on a medium

Delete program saved on a medium.

This operation is not available in command mode.

1. Execute step 1 to 3 of "Procedures for reading/saving/deleting program and formatting media".

2. Confirm that  is selected. Press .



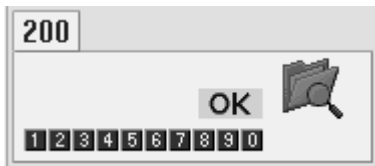

When checking program by displaying its image

4. Select . Press .



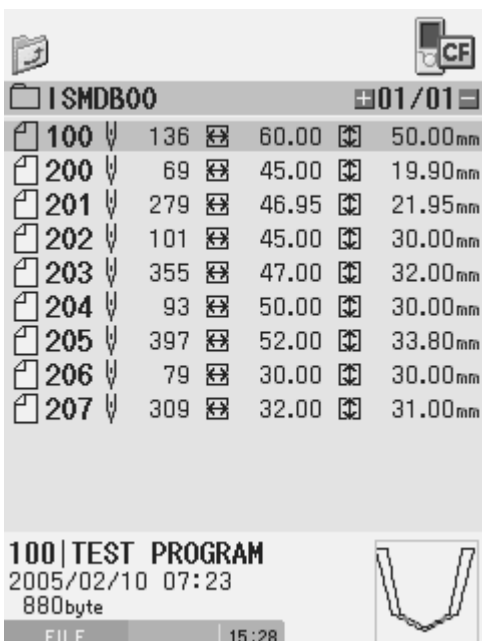

5. Select a program to delete, and then press .

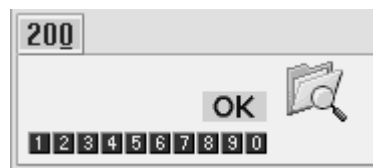

3. Input a program number to delete by using the numeric keys. Press .





6. To start deleting, press .
To cancel deleting, press .

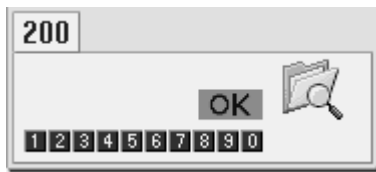

When not checking program by displaying its image

7. Select **OK**. Press .



8. To start deleting, press .
- To cancel deleting, press .

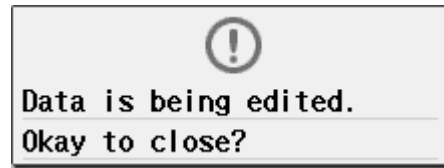

Formatting media



Formatting media

Format media to make them available for the programmer. The following two formatting procedures are provided. This operation is not available in command mode.

■ Formatting procedure 1

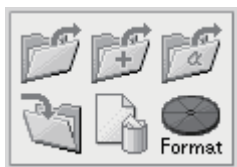

1. Execute step 1 to 3 of "Procedures for reading/saving/deleting program and formatting media".

2. Select  Format. Press .



3. Select a medium. Press .



4. To start formatting, press . To cancel formatting, press .

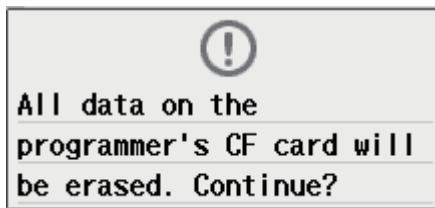

■ Formatting procedure 2

1. Select  TOOLS on the launcher screen. Press .





2. Select  Format. Press .



3. Select a medium. Press .



4. To start formatting, press . To cancel formatting, press .

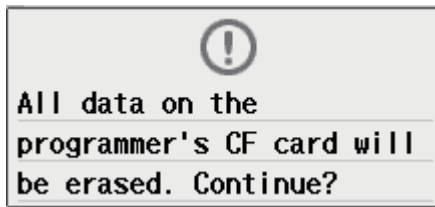

Chapter 7
**Checking/Copying/Moving/
Changing Program**

Checking program

Displaying program information

1. Press .

2. Select . Press .

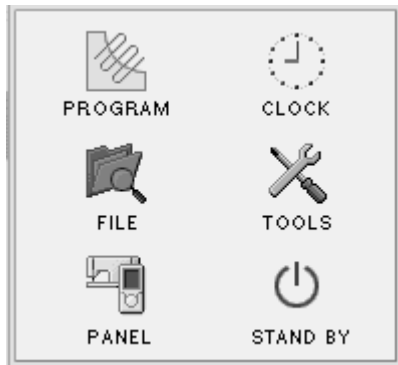

Selecting a program display method

You can select one of two kinds of program display methods, "Display of a list" and "Display of thumbnails".

Hold  down.

Every pressing switches between two displays.

■ Display of a list

Lists selected program in the folder of a media.

Displays program number

Displays stitch counts

Displays an access destination folder.

Displays an access destination medium.

Displays a program size.

Displays the number of pages.
Current page/entire number of pages

Program Number	Stitch Count	Stitch Length	Stitch Width	Program Size
100	136	60.00	50.00mm	
200	69	45.00	19.90mm	
201	279	46.95	21.95mm	
202	101	45.00	30.00mm	
203	355	47.00	32.00mm	
204	93	50.00	30.00mm	
205	397	52.00	33.80mm	
206	79	30.00	30.00mm	
207	309	32.00	31.00mm	

Displays a detail of program.

100 | TEST PROGRAM
2005/02/10 07:23
880byte
FILE | 14:37

■ Display of thumbnails

Displays selected program in the folder of a media in the form of thumbnails.

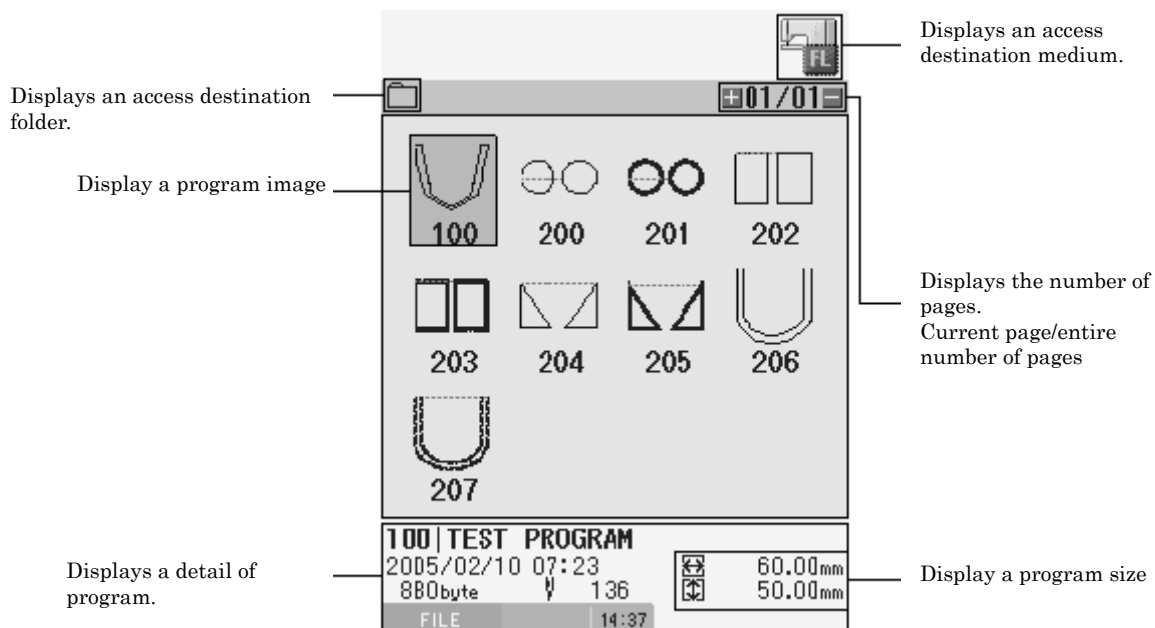

■ Switching between pages

To display the next page, press **+**. To display the previous page, press **-**.

■ Switching between folders

1. Select by using . Press .

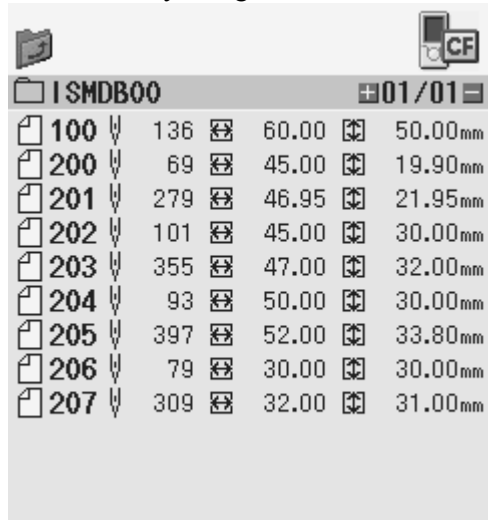

2. Select a target folder by using $\Delta \nabla$. Press \hookrightarrow .

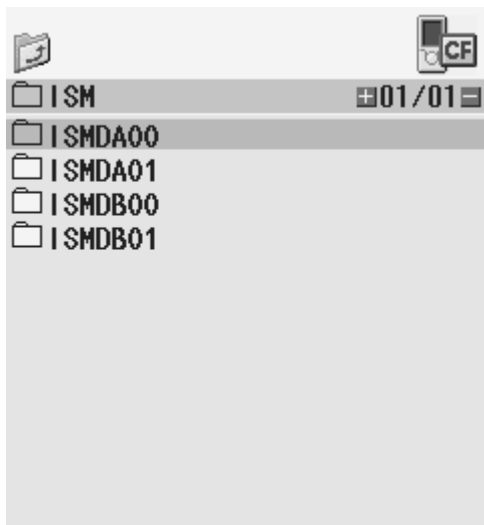

■ Switching between media

1. Select a media icon by using $\Delta \nabla$. Press \hookrightarrow .

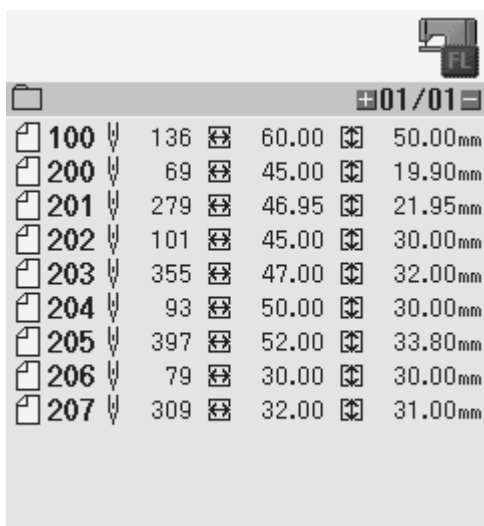



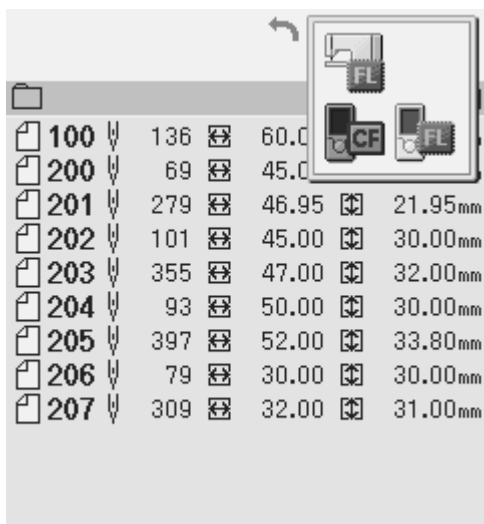

2. Select the icon of switching destination media by using $\Delta \nabla \triangleleft \triangleright$. Press \hookrightarrow .



Displaying detailed information of a file

Display the image and detailed information of a file.

1. Select a file of which detailed information you want to display. Press .
- The image and detailed information of the file are displayed.
2. To zoom in the image, press . To zoom out the image, press .
3. To return to the previous display, press .

Copying/moving/deleting program/renameing a file

Copy, move and delete program, and rename a file.

1. Select a file you want to manipulate. Press .

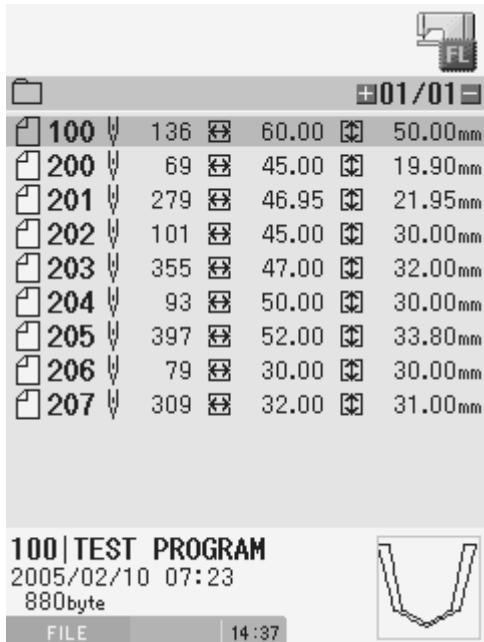

2. Select an icon from the file operation menu. Press .

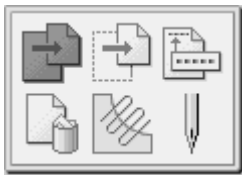



■ Copying program

Select .

1. Specify a copy destination.

When a "A file with the same name exists. Do you overwrite it?" message is issued



2. To start overwriting, press . To rename the file, press  to change the program number.

■ Moving program

Select .

1. Specify a move destination.

When a "A file with the same name exists. Do you overwrite it?" message is issued



2. To start overwriting, press . To rename the file, press  to change the program number.

■ Changing a program number

Select .

1. Input a program number. Press .





2. Input a comment by selecting characters using  . Press .

To switch between the upper case and lower case, press .

To change the comment input position, press .



Deletes the previous character.

3. Select **OK** by using  . Press .



■ Deleting program

Select .

When a "Cannot be redone after deletion. Are you sure?" message is issued

1. To start deleting, press . To cancel deleting, press .

■ Editing a program

Select .

The screen is switched to the programming screen where you can edit the program you selected.

■ Carrying out sewing according to a program

Select .

The screen is switched to the PANEL screen where you can carry out sewing according to the selected program.

Chapter 8

Displaying Sewing Machine Program

Displaying sewing machine program

Displaying sewing machine program

Display the program of a program number displayed on the panel of the sewing machine, on the programmer.

1. Press .

2. Select  . Press .

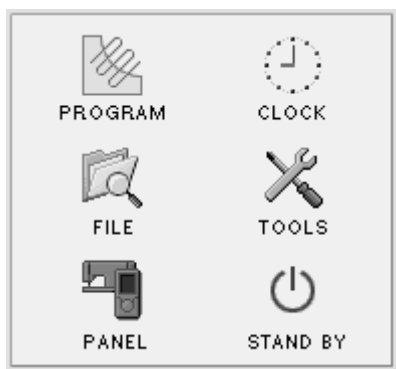

[Screen image]

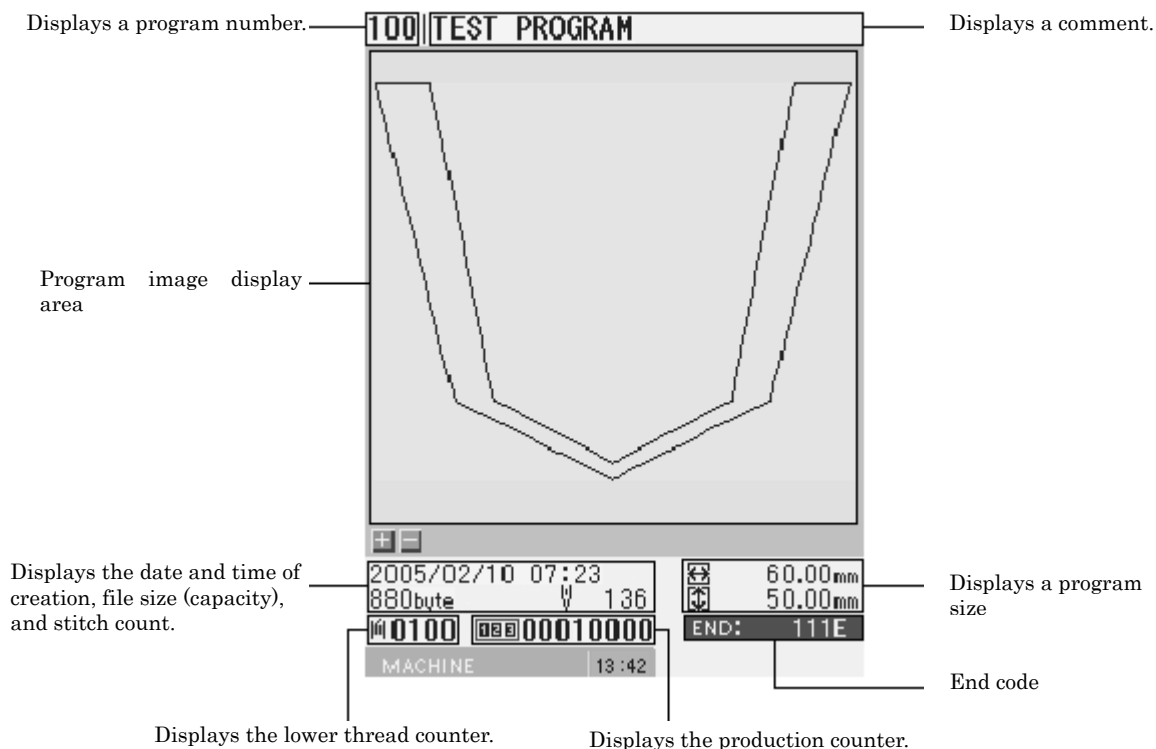

To zoom in the image, press  . To zoom out the image, press .

To switch to the launcher menu, press .

Chapter 9

Displaying a Clock

Displaying a clock

Displaying a clock

1. Press .

2. Select  **CLOCK**. Press .

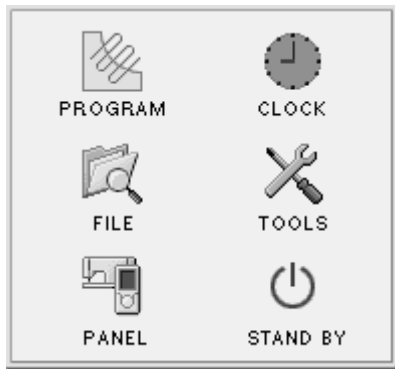



Selecting a clock display method

You can select one of two kinds of clock display methods, "analog display" and "digital display".

1. Press .

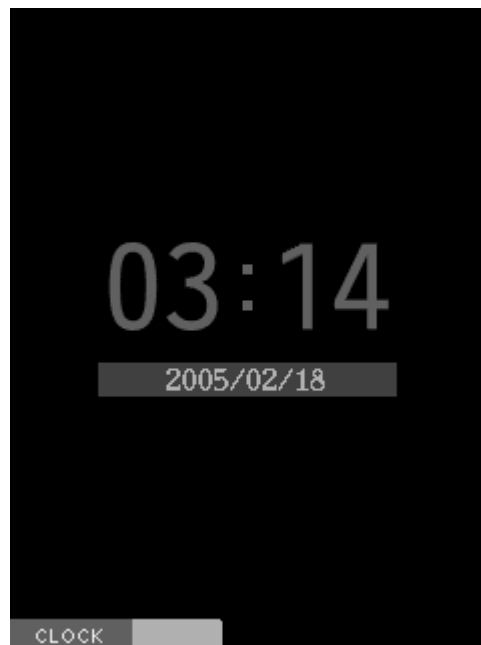
Every pressing switches between two displays.



Press  to return to the launcher screen.

Setting a clock

1. Select  TOOLS. Press .

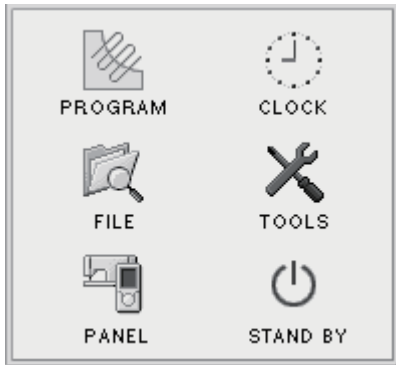

2. Select . Press .



3. Set the time. Press .

Additional Information

Upgrade

The programmer can be updated by the procedure below.

Caution

- Do not turn off PD3000 during the upgrading; otherwise, it may not turn on the next time.
- Use only the following CF cards.

Name of manufacturer	Model	Size
HAGIWARA SYS-COM	CFC-032MBA	32 M
SanDisk	SDCFB-64-J60	64 M
SanDisk	SDCFB-128-P60	128 M



1. Copy the "PD-3000.PRE" upgrade file into the root folder of the CF card.

Place only the "PD-3000.PRE" file in the root folder of the CF card.

If any other file resides in it, the programmer may not be upgraded.

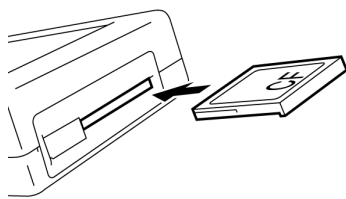
2. Turn off the programmer.
3. Load the CF card holding the copied upgrade file into the CF slot of the programmer.



4. While pressing  and  at the same time, turn on the programmer.

Upgrading starts.

If you see a message indicating upgrading completion on the screen, the upgrading is completed.

5. Turn on the programmer again.

A new program starts.

Troubleshooting

The programmer can be troubleshooted by the procedure below.

1. Turn off the programmer.
2.  While pressing  and  at the same time, turn on the programmer.

The self-diagnosis screen appears.



3. Carry out the operation following the instructions on screen.

If no instructions are given, press . If any failure is found by troubleshooting, the contents of the failure are displayed. Record them.



4. If the troubleshooting end screen appears, turn on the programmer again.
Inform your dealer of the failure.

Memory switch setting display function

The memory switch setting list of the connected sewing machine can be displayed by the procedure below.

1. Select  on the launcher screen. Press .





2. Select  by using . Press .



The list is displayed.



Settings

								01/03
Memory switch number	No.	Value	[Init,	Min,	Max]		Setting range of each memory switch [Initial, Minimum, Maximum]
	001 :	ON	[ON]		
	002 :	0	[0,	0,	2]		
	003 :	2	[2,	0,	2]		
	050 :	1	[1,	1,	11]		
	051 :	ON	[ON]		
	052 :	OFF	[OFF]		
	053 :	110	[100,	0,	999]		
	054 :	0	[0,	0,	2]		
	055 :	0	[0,	0,	2]		
	056 :	OFF	[OFF]		
	057 :	ON	[ON]		
	058 :	OFF	[OFF]		
	100 :	OFF	[OFF]		
	150 :	OFF	[OFF]		
	151 :	4	[4,	4,	30]		



Press  to display the next page, or press  to display the previous page.

Error log display function

The error log list of the connected sewing machine can be displayed by the procedure below.

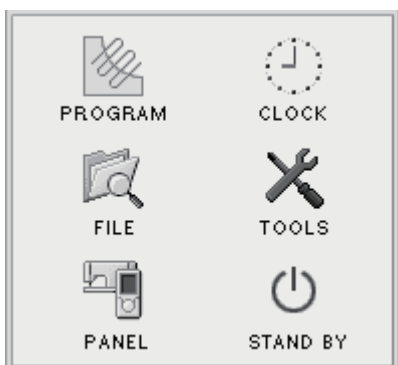
1. Select  on the launcher screen. Press .





2. Select  by using . Press .



The list is displayed.





Serial number	Error code	Time	01/02
Num	Error	Time	
001	: E010	10000	
002	: E011	10001	
003	: E015	10002	
004	: E016	10003	
005	: E025	20000	
006	: E035	30000	
007	: E036	30001	
008	: E050	50002	
009	: E051	50003	
010	: E055	50004	
011	: E065	100000	
012	: E110	1000001	
013	: E111	1000002	
014	: E120	1000003	
015	: E121	1000004	

The stitch counter's value when the error is occurred.

Press  to display the next page, or press  to display the previous page.

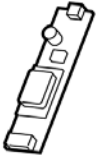
Spare parts

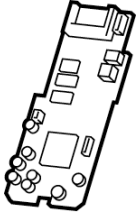
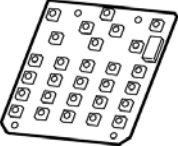
The following shows available spare parts.

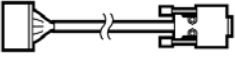
Part No.	Part name	
SA5164001	LCD MODULE	
SA5165001	LCD INVERTER	
SA5166001	INVERTER HARNESS	
SA5170001	PROGRAMMER PCB ASSY	
SA5172001	SWITCH PCB ASSY	
XD1115051	FFC:SML2CD – 20 X 70	
SA5167001	PROGRAMMER HARNESS	

brother®

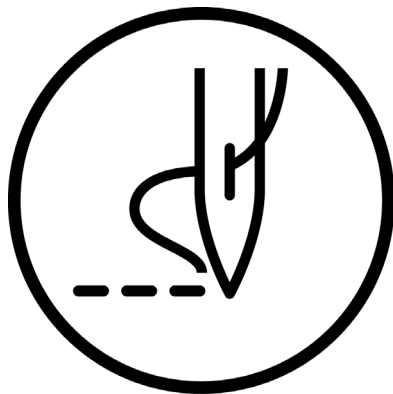

INSTRUCTION MANUAL

BROTHER INDUSTRIES, LTD. <http://www.brother.com/>
15-1, Naeshiro-cho, Mizuho-ku, Nagoya 467-8561, Japan. Phone: 81-52-824-2177

© 2005, 2006 Brother Industries, Ltd. All Rights Reserved.

PD-3000
SA6103-201 E
2006.01. B (1)

Free Manuals Download Website

<http://myh66.com>

<http://usermanuals.us>

<http://www.somanuals.com>

<http://www.4manuals.cc>

<http://www.manual-lib.com>

<http://www.404manual.com>

<http://www.luxmanual.com>

<http://aubethermostatmanual.com>

Golf course search by state

<http://golfingnear.com>

Email search by domain

<http://emailbydomain.com>

Auto manuals search

<http://auto.somanuals.com>

TV manuals search

<http://tv.somanuals.com>