

brother

Advanced User's Guide

MFC-J6920DW
MFC-J6925DW

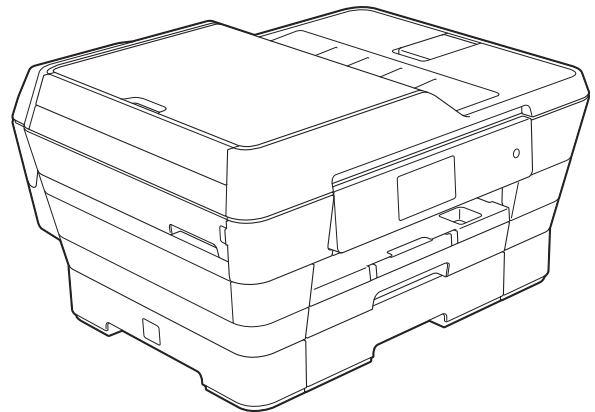

Version A

USA/CAN

User's Guides and where do I find them?

Which Guide?	What's in it?	Where is it?
Product Safety Guide	Read this Guide first. Please read the Safety Instructions before you set up your machine. See this Guide for trademarks and legal limitations.	Printed / In the box
Quick Setup Guide	Follow the instructions for setting up your machine, and installing the drivers and software for the operating system and connection type you are using.	Printed / In the box
Basic User's Guide	Learn the basic Fax, Copy, Scan and PhotoCapture Center™ operations and how to replace consumables. See troubleshooting tips.	Printed / In the box
Advanced User's Guide	Learn more advanced operations: Fax, Copy, security features, printing reports and performing routine maintenance.	PDF file / CD-ROM
Software and Network User's Guide	This Guide provides instructions for Scanning, Printing, PC-Fax and other operations that can be performed by connecting your Brother machine to a computer. You can also find useful information about using the Brother ControlCenter utility, using your machine in a network environment, and frequently used terms.	HTML file / CD-ROM
Web Connect Guide	This Guide provides useful information about accessing Internet services from the Brother machine, as well as downloading images, printing data and uploading files directly to Internet services.	PDF file / Brother Solutions Center ¹
AirPrint Guide	This Guide provides information for using AirPrint to print from OS X v10.7.x, 10.8.x and your iPhone, iPod touch, iPad, or other iOS device to your Brother machine without installing a printer driver.	PDF file / Brother Solutions Center ¹
Google Cloud Print Guide	This Guide provides details on how to use Google Cloud Print™ services for printing over the Internet.	PDF file / Brother Solutions Center ¹
Wi-Fi Direct™ Guide	This Guide provides details on how to configure and use your Brother machine for wireless printing directly from a mobile device supporting the Wi-Fi Direct™ standard.	PDF file / Brother Solutions Center ¹
Mobile Print/Scan Guide for Brother iPrint&Scan	This Guide provides useful information about printing from your mobile device and scanning from your Brother machine to your mobile device when connected to a Wi-Fi network.	PDF file / Brother Solutions Center ¹

¹ Visit us at <http://solutions.brother.com/>.

Table of Contents

1	General setup	1
	Memory Storage	1
	Volume Settings.....	1
	Ring Volume	1
	Beep Volume	2
	Speaker Volume	2
	Automatic Daylight Saving Time.....	3
	Sleep Mode	3
	Touchscreen LCD.....	4
	Setting the backlight brightness.....	4
	Setting the Dim Timer for the backlight	4
	Dial Prefix	5
	Setting up or changing the prefix number.....	5
2	Security features	6
	Secure Function Lock 2.0.....	6
	Before you begin to use Secure Function Lock 2.0.....	6
	Setting and changing the Administrator Password.....	7
	Setting up restricted users.....	8
	Turning Secure Function Lock on/off.....	8
	Switching users	9
	Changing to Public mode	9
	Restricting dialing	9
	Dial pad restriction.....	10
	Address Book restriction.....	10
	Shortcut restriction.....	10
	LDAP Server restriction	10
3	Sending a fax	11
	Additional sending options.....	11
	Sending faxes using multiple settings	11
	Stop faxing.....	11
	Contrast	12
	Changing fax resolution.....	12
	Setting your changes as the new default.....	13
	Restoring fax options to the factory settings.....	14
	Saving fax options as a Shortcut	14

Additional sending operations.....	15
Sending a 2-sided fax from the ADF (Automatic Document Feeder)	15
Sending a fax manually	15
Sending a fax at the end of a conversation	16
Dual Access (Black & White only)	16
Broadcasting (Black & White only)	16
Real Time Transmission.....	18
Overseas Mode	19
Delayed Faxing (Black & White only)	19
Delayed Batch Transmission (Black & White only)	20
Checking and canceling waiting jobs.....	20
Polling	21
Polled Transmit (Black & White only)	21

4 Receiving a fax 22

Memory Receive (Black & White only)	22
Fax Forwarding.....	22
Paging	23
Fax Storage	23
Printing a fax from the memory	24
Turning off Memory Receive operations.....	24
Changing Memory Receive operations	25
Remote Retrieval	26
Setting a Remote Access Code.....	26
Using your Remote Access Code.....	26
Remote Fax commands	27
Retrieving fax messages	28
Changing your Fax Forwarding number	28
Additional receiving operations.....	29
Receiving faxes into memory when paper tray is empty	29
Printing a reduced incoming fax	29
Receiving a fax at the end of a conversation.....	29
Polling	30
Polling receive	30

5 Dialing and storing numbers 32

Voice operations	32
Tone or Pulse (Canada only).....	32
Fax/Tel mode.....	32
Caller ID.....	32
Special line considerations	33
Additional dialing operations.....	35
Outgoing Call History.....	35
Caller ID history	35
Dialing access codes and credit card numbers	36
Additional ways to store numbers.....	37
Storing Address Book numbers from the Outgoing Call history	37
Storing Address Book numbers from the Caller ID history	37
Setting up Groups for Broadcasting	38

6	Printing reports	40
	Fax reports.....	40
	Transmission Verification Report.....	40
	Fax Journal (activity report).....	40
	Reports.....	41
	How to print a report.....	41
7	Making copies	42
	Copy options.....	42
	Stop copying.....	42
	Improving copy quality.....	42
	Enlarging or reducing copies.....	43
	Making N in 1 copies or a poster (Page Layout).....	44
	2 in 1 ID Copy (Page Layout).....	47
	Sorting copies using the ADF.....	48
	Adjusting Density.....	48
	Ink Save Mode.....	49
	Thin Paper Copy.....	50
	Auto Deskew.....	50
	Book Copy.....	51
	Watermark Copy.....	51
	Remove Background Color.....	52
	2-sided copying.....	53
	Saving copy options as a Shortcut.....	55
	Ledger Copy Shortcuts.....	55
	Ledger Copy Shortcut.....	55
8	PhotoCapture Center™: Printing photos from a memory card or USB Flash drive	58
	PhotoCapture Center™ operations.....	58
	Memory cards, USB Flash drives and folder structures.....	58
	Movie printing.....	59
	Print Images.....	59
	Print Index (Thumbnails).....	59
	Printing Photos.....	60
	Enhance Photos.....	60
	ID photo print.....	62
	Slide Show.....	63
	DPOF printing.....	64
	PhotoCapture Center™ print settings.....	65
	Print Quality.....	65
	Paper options.....	65
	Auto Correct.....	67
	Adjusting Brightness, Contrast and Color.....	67
	Cropping.....	69
	Borderless printing.....	70
	Print Date.....	70
	Setting your changes as the new default.....	71
	Restoring all settings to the factory settings.....	71

Memory Storage



Your menu settings are stored permanently, and, in the event of a power failure, will not be lost. Temporary settings (for example, `Overseas Mode`) will be lost. If you have chosen `Set New Default` for your `Fax`, `Scan` and `Photo` preferred settings, those settings will not be lost. Also, during a power failure, the machine will retain the date and time and programmed fax timer jobs (for example, `Delayed Fax`) for approximately 24 hours.

Volume Settings

Ring Volume

You can choose a range of ring volume levels, from `High` to `Off`. The machine will keep your new default setting until you change it.



Setting the Ring Volume from the menu

- 1 Press .
- 2 Press `All Settings`.
- 3 Swipe up or down, or press `▲` or `▼` to display `General Setup`.
- 4 Press `General Setup`.
- 5 Swipe up or down, or press `▲` or `▼` to display `Volume`.
- 6 Press `Volume`.
- 7 Press `Ring`.
- 8 Press `Low`, `Med`, `High` or `Off`.
- 9 Press .

Beep Volume



When the beep is on, the machine will make a sound when you press the Touchscreen or Touchpanel, make a mistake, or after you send or receive a fax.

You can choose a range of sound volume levels, from *High* to *Off*.







- 1 Press .
- 2 Press *All Settings*.
- 3 Swipe up or down, or press ▲ or ▼ to display *General Setup*.
- 4 Press *General Setup*.
- 5 Swipe up or down, or press ▲ or ▼ to display *Volume*.
- 6 Press *Volume*.
- 7 Press *Beep*.
- 8 Press *Low, Med, High or Off*.
- 9 Press .

Speaker Volume

You can choose a range of speaker volume levels, from *High* to *Off*.

- 1 Press .
- 2 Press *All Settings*.
- 3 Swipe up or down, or press ▲ or ▼ to display *General Setup*.
- 4 Press *General Setup*.
- 5 Swipe up or down, or press ▲ or ▼ to display *Volume*.
- 6 Press *Volume*.
- 7 Press *Speaker*.
- 8 Press *Low, Med, High or Off*.
- 9 Press .



You can also adjust the speaker volume by pressing *Hook*.

- 1 Do one of the following:
 - When *Fax Preview* is set to *Off*, press  (*Fax*).
 - When *Fax Preview* is set to *On*, press  (*Fax*) and then  (*Sending Faxes*).
- 2 Press *Hook*.
- 3 Press  or .
- 4 Press  to decrease or  to increase the speaker volume level. Each press changes the volume to the next setting.
- 5 Press *Hook*.

Automatic Daylight Saving Time



You can set the machine to change automatically for daylight saving time. It will reset itself forward one hour in the Spring and backward one hour in the Fall. Make sure you have set the correct date and time in the `Date & Time` setting.

The factory setting is `Off`, so you will have to turn on Automatic Daylight Saving Time as follows.

- 1 Press .
- 2 Press .
- 3 Swipe up or down, or press ▲ or ▼ to display `Auto Daylight`.
- 4 Press `Auto Daylight`.
- 5 Press `On` (or `Off`).
- 6 Press .

Sleep Mode



You can choose how long the machine must be idle (up to 60 minutes) before it goes into Sleep Mode. The timer will restart if any operation is carried out on the machine.

- 1 Press .
- 2 Press `All Settings`.
- 3 Swipe up or down, or press ▲ or ▼ to display `General Setup`.
- 4 Press `General Setup`.
- 5 Swipe up or down, or press ▲ or ▼ to display `Sleep Mode`.
- 6 Press `Sleep Mode`.
- 7 Swipe up or down, or press ▲ or ▼ to display `1Min`, `2Mins`, `3Mins`, `5Mins`, `10Mins`, `30Mins` or `60Mins` to choose the length of time the machine must be idle before entering Sleep Mode. Press the option you want to set.
- 8 Press .

Touchscreen LCD



Setting the backlight brightness

You can adjust the brightness of the Touchscreen LCD backlight. If you are having difficulty reading the LCD, try changing the brightness setting.

- 1 Press .
- 2 Press All Settings.
- 3 Swipe up or down, or press ▲ or ▼ to display General Setup.
- 4 Press General Setup.
- 5 Swipe up or down, or press ▲ or ▼ to display LCD Settings.
- 6 Press LCD Settings.
- 7 Press Backlight.
- 8 Press Light, Med or Dark.
- 9 Press .

Setting the Dim Timer for the backlight

You can set how long the Touchscreen LCD backlight stays on after the last finger press.

- 1 Press .
- 2 Press All Settings.
- 3 Swipe up or down, or press ▲ or ▼ to display General Setup.
- 4 Press General Setup.
- 5 Swipe up or down, or press ▲ or ▼ to display LCD Settings.
- 6 Press LCD Settings.
- 7 Press Dim Timer.
- 8 Press 10Secs, 20Secs, 30Secs or Off.
- 9 Press .

Dial Prefix

The Dial Prefix setting will automatically dial a predefined number before every fax number you dial. For example, if your telephone system requires a “9” to dial an outside number, use this setting to automatically dial 9 for every fax you send.

Setting up or changing the prefix number

- 1 Press .
- 2 Press All Settings.
- 3 Swipe up or down, or press ▲ or ▼ to display Initial Setup.
- 4 Press Initial Setup.
- 5 Swipe up or down, or press ▲ or ▼ to display Dial Prefix.
- 6 Press Dial Prefix.
- 7 Press On (or Off).
- 8 Press Dial Prefix.
- 9 Enter the prefix number (up to 5 digits) using the keyboard on the Touchscreen.
- 10 Press OK.

NOTE

- If your telephone system requires a timed break recall (hookflash), press ! on the Touchscreen.
 - You cannot use ! with any other numbers or characters.
 - (Canada only) If the pulse dialing mode is on, # and * are not available to use.
-

- 11 Press .

Secure Function Lock 2.0

Secure Function Lock lets you restrict public access to certain machine functions:

- Fax Send
- Fax Receive
- Copy
- Scan
- Print from Media
- Scan to Media
- PC Print
- Color Print
- Page Limit
- Web Upload
- Web Download

This feature also prevents users from changing the default settings of the machine by limiting access to the menu settings.

Before using the security features, you must first enter an administrator password.

Access to restricted operations can be enabled by creating a restricted user. Restricted users must enter a password to use the machine.

Make a careful note of your password. If you forget it, please call Brother Customer Service.

NOTE

- Only administrators can set limitations and make changes for each user.
- If Fax Tx is disabled, you cannot use any functions in the Fax menu.
- Polled Transmit and Polling Receive are enabled only when both Fax Tx and Fax Rx are enabled.
- You cannot edit or delete a Shortcut when Secure Function Lock is set to On.

Before you begin to use Secure Function Lock 2.0

You can configure Secure Function Lock 2.0 settings using a Web browser. Before configuration, the following preparations are needed.

- 1 Start your Web browser.
- 2 Type "http://machine's IP address/" into your browser's address bar (where "machine's IP address" is the Brother machine's IP address).

- For example:

`http://192.168.1.2/`

NOTE

You can find the machine's IP address in the Network Configuration List.

For more information, see *Software and Network User's Guide: Set Up Public Mode*.

- 3 Enter a password in the **Login** box. (This is a password to log into the machine's Web page, not the administrator password for Secure Function Lock.) Click .

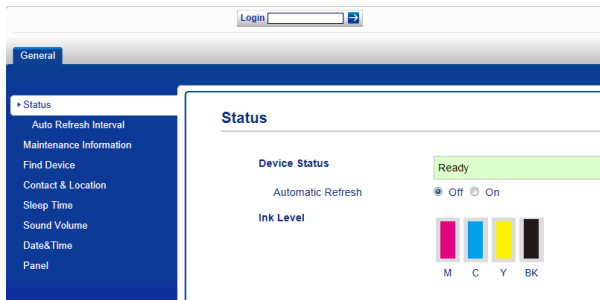

NOTE

If you are using a Web browser to configure the machine's settings for the first time, set a password.

- 1 Click **Please configure the password.**
- 2 Enter a password you want to use (up to 32 characters).
- 3 Re-enter the password in the **Confirm New Password** box.
- 4 Click **Submit.**

Setting and changing the Administrator Password

You can configure these settings using a Web browser. To set up the Web page, see *Before you begin to use Secure Function Lock 2.0* on page 6. Then follow the instructions below.

Setting the administrator password

The password you set in these steps is for the administrator. This password is used to set up users and to turn Secure Function Lock on or off. (See *Setting up restricted users* on page 8 and *Turning Secure Function Lock on/off* on page 8.)

- 1 Click **Administrator.**
- 2 Click **Secure Function Lock.**
- 3 Enter a four-digit number for the password in the **New Password** box.



- 4 Re-enter the password in the **Retype Password** box.
- 5 Click **Submit.**

Changing the administrator password

- 1 Click **Administrator.**
- 2 Click **Secure Function Lock.**
- 3 Enter a four-digit number for the new password in the **New Password** box.
- 4 Re-enter the new password in the **Retype Password** box.
- 5 Click **Submit.**

Setting up restricted users

You can set up users with restrictions and a password. You can set up to 10 restricted users.

You can configure these settings using a Web browser.

To set up the Web page, see *Before you begin to use Secure Function Lock 2.0* on page 6. Then follow the instructions below.

- 1 Click **Administrator**.
- 2 Click **Secure Function Lock**.
- 3 Enter an alphanumeric Group name or User name (up to 15 characters) in the **ID Number/Name** box and then enter a four-digit password in the **PIN** box.



- 4 Uncheck the functions that you want to restrict in the **Function Restrictions** boxes. If you want to configure the maximum page count, check the **On** box in **Print Limits**, and then enter the number in the **Max. Pages** box. Then click **Submit**.

NOTE

- You cannot use the same password as another user's password.
 - You can set up one Public user. Public users do not need to enter a password.
- For more information, see *Software and Network User's Guide: Set Up Public Mode*.

Turning Secure Function Lock on/off

NOTE

Make a careful note of the administrator password. If you enter the wrong password, the Touchscreen will show **Wrong Password**. Enter the correct password. If you forget it, please call Brother Customer Service.

Turning Secure Function Lock on



- 1 Press .
- 2 Press **All Settings**.
- 3 Swipe up or down, or press **▲** or **▼** to display **General Setup**.
- 4 Press **General Setup**.
- 5 Swipe up or down, or press **▲** or **▼** to display **Function Lock**.
- 6 Press **Function Lock**.
- 7 Press **Lock Off→On**.
- 8 Enter your four-digit administrator password using the keyboard on the Touchscreen. Press **OK**.

NOTE

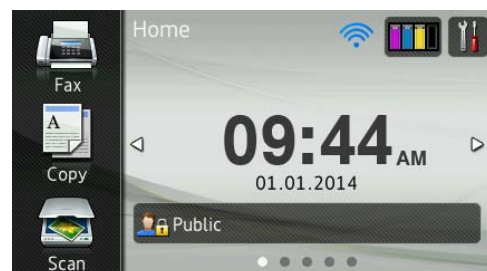
The Secure Function Lock icon is prominently displayed in Home screen.



Turning Secure Function Lock off

- 1 Press  or  (where xxxxx is the user's name).
- 2 Press `Lock On→Off`.
- 3 Enter your four-digit administrator password using the keyboard on the Touchscreen.
Press `OK`.

Switching users

This setting allows a restricted user to log on to the machine when Secure Function Lock is turned on.

- 1 On the Touchscreen, press  or  (where xxxxx is the user's name).
- 2 Press `Change User`.
- 3 Swipe up or down, or press `▲` or `▼` to display your user name.
- 4 Press your user name.
- 5 Enter your four-digit user password using the keyboard on the Touchscreen.
Press `OK`.

Changing to Public mode

- 1 Press  (where xxxxx is the user's name).
- 2 Press `Go to Public`.

Restricting dialing

This feature prevents users from sending a fax or call to a wrong number by mistake. You can set the machine to restrict dialing when you use the dial pad, Address Book, Shortcut and LDAP search.

If you choose `Off`, the machine does not restrict the dialing method.



If you choose `Enter # Twice`, the machine will prompt you to re-enter the number, and will start dialing after you re-enter the number correctly. If you re-enter the wrong number, the Touchscreen will show `Try again`. Press `Close` and enter the number twice again.

If you choose `On`, the machine will restrict all fax sending and outbound calls for that dialing method.



NOTE

- The `Enter # Twice` setting will not work if you use an external phone or press `Hook` before entering the number. You will not be asked to re-enter the number.
- If you chose `On` or `Enter # Twice`, you cannot use the Broadcasting feature.

Dial pad restriction

- 1 Press .
- 2 Press All Settings.
- 3 Swipe up or down, or press ▲ or ▼ to display Fax.
- 4 Press Fax.
- 5 Swipe up or down, or press ▲ or ▼ to display Dial Restriction.
- 6 Press Dial Restriction.
- 7 Press Dial Pad.
- 8 Press Enter # Twice, On or Off.
- 9 Press .



Address Book restriction

- 1 Press .
- 2 Press All Settings.
- 3 Swipe up or down, or press ▲ or ▼ to display Fax.
- 4 Press Fax.
- 5 Swipe up or down, or press ▲ or ▼ to display Dial Restriction.
- 6 Press Dial Restriction.
- 7 Press Address Book.
- 8 Press Enter # Twice, On or Off.
- 9 Press .



NOTE

If you combine Address Book numbers when dialing, the address will be recognized as dial pad input and will not be restricted.

Shortcut restriction

- 1 Press .
- 2 Press All Settings.
- 3 Swipe up or down, or press ▲ or ▼ to display Fax.
- 4 Press Fax.
- 5 Swipe up or down, or press ▲ or ▼ to display Dial Restriction.
- 6 Press Dial Restriction.
- 7 Press Shortcuts.
- 8 Press Enter # Twice, On or Off.
- 9 Press .

LDAP Server restriction

- 1 Press .
- 2 Press All Settings.
- 3 Swipe up or down, or press ▲ or ▼ to display Fax.
- 4 Press Fax.
- 5 Swipe up or down, or press ▲ or ▼ to display Dial Restriction.
- 6 Press Dial Restriction.
- 7 Press LDAP Server.
- 8 Press Enter # Twice, On or Off.
- 9 Press .

3

Sending a fax



Additional sending options

Sending faxes using multiple settings

When you send a fax, you can choose a combination of settings, such as Fax Resolution, 2-sided Fax, Contrast, Glass Scan Size, and Real Time TX.

You can also choose Call History, Address Book, Broadcasting, Preview, Color Setting, Delayed Fax, Batch TX, Polled TX, Polling RX, Overseas Mode, Set New Default, and Factory Reset.

Some settings are only available when sending black & white faxes.

- 1 Load your document.
- 2 Do one of the following:
 - When Fax Preview is set to Off, press  (Fax).
 - When Fax Preview is set to On, press  (Fax) and then  (Sending Faxes).

The Touchscreen shows:

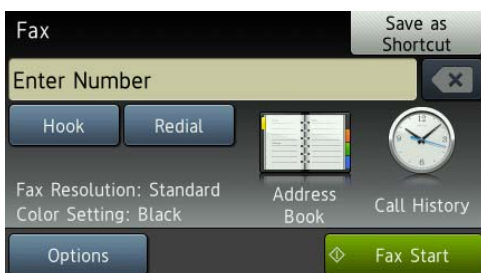

- 3 Press Options.

- 4 Swipe up or down, or press ▲ or ▼ to display the setting you want to change. When the setting is displayed, press it.
- 5 Press the option you want to set.
- 6 Repeat steps 4 and 5 to change additional settings.
- 7 Press OK when you are finished changing settings.
- 8 Enter the fax number.
- 9 Press Fax Start.

NOTE

- Most settings are temporary, and the machine returns to its default settings after you send a fax.
- You can save some of the settings you use most often by setting them as the default settings. These settings will remain until you change them again. (See *Setting your changes as the new default* on page 13.)
- You can also save some of the settings you use most often by setting them as a Shortcut. (See *Saving fax options as a Shortcut* on page 14.)



Stop faxing

To stop faxing, press .

Contrast

If your document is very light or very dark, you may want to change the contrast. For most documents, the factory setting **Auto** can be used. **Auto** chooses the suitable contrast for your document.

Choose **Light** when sending a light document. Choose **Dark** when sending a dark document.

- 1 Load your document.
- 2 Do one of the following:
 - When Fax Preview is set to **Off**, press  (**Fax**).
 - When Fax Preview is set to **On**, press  (**Fax**) and then  (**Sending Faxes**).
- 3 Press **Options**.
- 4 Swipe up or down, or press **▲** or **▼** to display **Contrast**.
- 5 Press **Contrast**.
- 6 Press **Auto**, **Light** or **Dark**.
- 7 Press **OK**.
- 8 Enter the fax number.
- 9 Press **Fax Start**.



NOTE

Even if you choose **Light** or **Dark**, the machine will send the fax using the **Auto** setting in the following conditions:

- When you send a color fax.
- When you choose **Photo** as the Fax Resolution.

Changing fax resolution

The quality of a fax can be improved by changing the fax resolution.

- 1 Load your document.
- 2 Do one of the following:
 - When Fax Preview is set to **Off**, press  (**Fax**).
 - When Fax Preview is set to **On**, press  (**Fax**) and then  (**Sending Faxes**).
- 3 Press **Options**.
- 4 Swipe up or down, or press **▲** or **▼** to display **Fax Resolution**.
- 5 Press **Fax Resolution**.
- 6 Press **Standard**, **Fine**, **S.Fine** or **Photo**.
- 7 Press **OK**.
- 8 Enter the fax number.
- 9 Press **Fax Start**.

NOTE

You can choose four different resolution settings for black & white faxes and two for color faxes.



Black & White	
Standard	Suitable for most typed documents.
Fine	Good for small print and transmits a little slower than Standard resolution.
S.Fine	Good for small print or artwork and transmits slower than Fine resolution.
Photo	Use when the document has varying shades of gray or is a photograph. Photo has the slowest transmission.

Color	
Standard	Suitable for most typed documents.
Fine	Use when the document is a photograph. The transmission time is slower than Standard resolution.

If you choose S.Fine or Photo and then send a color fax (choosing Color in Color Setting), the machine will send the fax using the Fine setting.

Setting your changes as the new default





You can store the fax options you use frequently for Fax Resolution, Contrast, Glass Scan Size, Preview, Real Time TX and Color Setting by saving them as the default settings. These settings will remain until you change them again.

- 1 Do one of the following:
 - When Fax Preview is set to Off, press  (Fax).
 - When Fax Preview is set to On, press  (Fax) and then  (Sending Faxes).
- 2 Press Options.
- 3 Swipe up or down, or press ▲ or ▼ to choose the setting you want to change, and then press your new option.

Repeat this step for each setting you want to change.
- 4 After changing the last setting to your preferred option, swipe up or down, or press ▲ or ▼ to display Set New Default.
- 5 Press Set New Default.
- 6 The Touchscreen asks you to confirm the change to the new default settings. Press Yes to confirm.
- 7 Press .



Restoring fax options to the factory settings

You can restore all the fax options you have changed back to the factory settings. These settings will remain until you change them again.

- 1 Do one of the following:
 - When Fax Preview is set to `Off`, press  (`Fax`).
 - When Fax Preview is set to `On`, press  (`Fax`) and then  (`Sending Faxes`).
- 2 Press `Options`.
- 3 Swipe up or down, or press `▲` or `▼` to display `Factory Reset`.
- 4 Press `Factory Reset`.
- 5 The Touchscreen asks you to confirm to change back to the factory settings. Press `Yes` to confirm.
- 6 Press .

Saving fax options as a Shortcut

You can store all the new fax options you use frequently by saving them as a Shortcut.

- 1 Do one of the following:
 - When Fax Preview is set to `Off`, press  (`Fax`).
 - When Fax Preview is set to `On`, press  (`Fax`) and then  (`Sending Faxes`).

- 2 Enter the fax number.

NOTE

If the Shortcut is to be used for broadcasting, press `Options` and choose `Broadcasting` in step 4 before entering the fax number in step 2.



(See *Broadcasting (Black & White only)* on page 16.)



- 3 Press `Options`.
- 4 Swipe up or down, or press `▲` or `▼` to display `Fax Resolution`, `2-sided Fax`, `Contrast`, `Glass Scan Size`, `Preview`, `Color Setting`, `Real Time TX` or `Overseas Mode`, and then press the setting you want to change. Then press the new option you want to set. Repeat this step for each setting you want to change.
- 5 When you are finished choosing new options, press `OK`.
- 6 Press `Save as Shortcut`.
- 7 Confirm the displayed list of options you have chosen for the Shortcut, and then press `OK`.
- 8 Enter a name for the Shortcut using the keyboard on the Touchscreen. (For help entering letters, see *Basic User's Guide: Entering Text*.) Press `OK`.
- 9 Press `OK` to save your Shortcut.

Additional sending operations

Sending a 2-sided fax from the ADF (Automatic Document Feeder)

You can send 2-sided documents up to Legal size from the ADF.

- 1 Load your document in the ADF.
- 2 Do one of the following:
 - When Fax Preview is set to Off, press  (Fax).
 - When Fax Preview is set to On, press  (Fax) and then  (Sending Faxes).
- 3 Press Options.
- 4 Swipe up or down, or press ▲ or ▼ to display 2-sided Fax.
- 5 Press 2-sided Fax.
- 6 Do one of the following:
 - If your document is flipped on the Long edge, press 2-sided Scan: Long Edge.

Long edge	
Portrait	Landscape
	

- If your document is flipped on the Short edge, press 2-sided Scan: Short Edge.

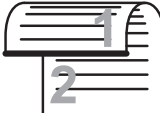
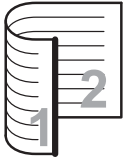
Short edge	
Portrait	Landscape
	

- 7 Press OK.
- 8 Enter the fax number.
- 9 Press Fax Start.



The machine will now scan and send your document.

Sending a fax manually

Manual transmission lets you hear the dialing, ringing and fax-receiving tones while sending a fax.

NOTE

To send a multi-page fax, use the ADF.

- 1 Load your document.
- 2 Do one of the following:
 - When Fax Preview is set to Off, press  (Fax).
 - When Fax Preview is set to On, press  (Fax) and then  (Sending Faxes).
- 3 To listen for a dial tone, press Hook.
- 4 Dial the fax number.

- 5 When you hear the fax tones, press **Fax Start**.
If you are using the scanner glass, press **Send** on the Touchscreen to send the fax.

Sending a fax at the end of a conversation

At the end of a conversation, you can send a fax to the other party before you both hang up.

- 1 Ask the other party to wait for fax tones (beeps) and then to press the **Start** or **Send** key before hanging up.
- 2 Load your document.
- 3 Press **Fax Start**.
If you are using the scanner glass, press **Send** to send the fax.
- 4 Replace the handset of the external phone.

Dual Access (Black & White only)

You can dial a number and start scanning the fax into memory—even when the machine is sending from memory, receiving faxes or printing PC data. The Touchscreen shows the new job number.

The number of pages you can scan into the memory will vary depending on the data that is printed on them.

NOTE

If the **Out of Memory** message appears, press  or **Quit** to cancel or **Send Now** to send the pages scanned so far.

Broadcasting (Black & White only)

Broadcasting is automatically sending the same fax message to more than one fax number. You can include Groups, Address Book numbers, and up to 50 manually dialed numbers in the same broadcast.



After the broadcast is finished, a Broadcast Report will be printed.

Before you begin the broadcast

Address Book numbers must be stored in the machine's memory before they can be used in a broadcast. (See Basic User's Guide: *Storing Address Book numbers*.)

Group numbers must also be stored in the machine's memory before they can be used in a broadcast. Group numbers include many stored Address Book numbers for easier dialing. (See *Setting up Groups for Broadcasting* on page 38.)

How to broadcast a fax

- 1 Load your document.
- 2 Do one of the following:
 - When Fax Preview is set to **Off**, press  (**Fax**).
 - When Fax Preview is set to **On**, press  (**Fax**) and then  (**Sending Faxes**).
- 3 Press **Options**.
- 4 Swipe up or down, or press **▲** or **▼** to display **Broadcasting**.
- 5 Press **Broadcasting**.
- 6 Press **Add Number**.

- 7** You can add numbers to the broadcast in the following ways:

- Press **Add Number** and enter a number using the keyboard on the Touchscreen.

Press **OK**.

NOTE

If you downloaded Internet Fax:

If you want to broadcast using an E-mail

address, press , enter the E-mail address, and press **OK**. (See Basic User's Guide: *Entering Text*.)

- Press **Add from Address book**.

Swipe up or down, or press **▲** or **▼** to display the number you want to add to the broadcast.

Press the check boxes of the numbers you want to add to the broadcast.

After you have checked all the numbers you want, press **OK**.

- Press **Search in Address book**.
Enter the first letter of the name and press **OK**.
Press the name, and then press the number you want to add to the broadcast.

- 8** After you have entered all the fax numbers by repeating steps **6** and **7**, press **OK**.

- 9** Press **Fax Start**.

NOTE

Broadcasting is not available when you select **Color** in **Color Setting**.

Faxing from the ADF

- The machine starts scanning and sending the document.

Faxing from the scanner glass

When the Touchscreen asks you **Next page?**, do one of the following:

- To send a single page, press **No**.
The machine starts sending the document.
- To send more than one page, press **Yes** and place the next page on the scanner glass.



Press **OK**.

The machine starts scanning the page. (Repeat this step for each page.)

NOTE

- If you did not use up any of the numbers for **Groups**, you can broadcast faxes to as many as 250 different numbers.
- The machine's available memory will vary depending on the types of jobs in the memory and the numbers used for broadcasting. If you broadcast to the maximum number available, you will not be able to use dual access and delayed fax.
- If the **Out of Memory** message appears, press  or **Quit** to cancel or **Send Now** to send the pages scanned so far.



Canceling a Broadcast in progress

- 1 Press .
- 2 Do one of the following:
 - To cancel the entire broadcast, press `Entire Broadcast`. Go to step 3.
 - To cancel the current job, press the name or number being dialed on the Touchscreen. Go to step 4.
 - To exit without canceling, press .
- 3 When the Touchscreen asks if you want to cancel the entire broadcast, do one of the following:
 - Press `Yes` to confirm.
 - To exit without canceling, press `No`.
- 4 Do one of the following:
 - To cancel the current job, press `Yes`.
 - To exit without canceling, press `No`.

Real Time Transmission

When you are sending a fax, the machine will scan the document into the memory before sending it. Then, as soon as the telephone line is free, the machine will start dialing and sending.

Sometimes, you may want to send an important document immediately, without waiting for memory transmission. You can do this by turning on `Real Time TX`.



- 1 Load your document.
- 2 Do one of the following:
 - When `Fax Preview` is set to `Off`, press  (`Fax`).
 - When `Fax Preview` is set to `On`, press  (`Fax`) and then  (`Sending Faxes`).
- 3 Press `Options`.
- 4 Swipe up or down, or press `▲` or `▼` to display `Real Time TX`.
- 5 Press `Real Time TX`.
- 6 Press `On` (or `Off`).
- 7 Press `OK`.
- 8 Enter the fax number.
- 9 Press `Fax Start`.

NOTE

- If you are sending a color fax or if the memory is full and you are sending a black & white fax from the ADF, the machine will send the document in real time (even if `Real Time TX` is set to `Off`).
- In Real Time Transmission, the automatic redial feature does not work when you are using the scanner glass.



Overseas Mode

If you are having difficulty sending a fax overseas due to possible interference on the telephone line, we recommend that you turn on Overseas Mode. After you send a fax using this feature, the feature will turn itself off.

- 1 Load your document.
- 2 Do one of the following:
 - When Fax Preview is set to Off, press  (Fax).
 - When Fax Preview is set to On, press  (Fax) and then  (Sending Faxes).
- 3 Press Options.
- 4 Swipe up or down, or press ▲ or ▼ to display Overseas Mode.
- 5 Press Overseas Mode.
- 6 Press On (or Off).
- 7 Press OK.
- 8 Enter the fax number.
- 9 Press Fax Start.

Delayed Faxing (Black & White only)

You can store up to 50 faxes in the memory to be sent within 24 hours. These faxes will be sent at the time of day you enter in step 9.

- 1 Load your document.
- 2 Do one of the following:
 - When Fax Preview is set to Off, press  (Fax).
 - When Fax Preview is set to On, press  (Fax) and then  (Sending Faxes).
- 3 Press Options.
- 4 Swipe up or down, or press ▲ or ▼ to display Delayed Fax.
- 5 Press Delayed Fax.
- 6 Press Delayed Fax.
- 7 Press On (or Off).
- 8 Press Set Time.
- 9 To enter the time you want the fax to be sent, do one of the following:
 - If you have set 12h Clock as the format in the Clock Type setting, enter the time (in 12-hour format) using the keyboard on the Touchscreen, and then press AM or PM.
Press OK.
 - If you have set 24h Clock in the Clock Type setting, enter the time (in 24-hour format) using the keyboard on the Touchscreen.
Press OK.
(For example, enter 19:45 for 7:45 PM.)

NOTE

The number of pages you can scan into the memory depends on the amount of data that is printed on each page.





- 10 Press **OK**.
- 11 Enter the fax number.
- 12 Press **Fax Start**.

NOTE

Delayed Fax is not available when you select **Color** in **Color Setting**.



Delayed Batch Transmission (Black & White only)

Before sending the delayed faxes, your machine will help you economize by sorting all the faxes in the memory by destination and scheduled time. All delayed faxes that are scheduled to be sent at the same time to the same fax number will be sent as one fax to save transmission time.

- 1 Do one of the following:
 - When **Fax Preview** is set to **Off**, press  (**Fax**).
 - When **Fax Preview** is set to **On**, press  (**Fax**) and then  (**Sending Faxes**).
- 2 Press **Options**.
- 3 Swipe up or down, or press **▲** or **▼** to display **Batch TX**.
- 4 Press **Batch TX**.
- 5 Press **On** (or **Off**).
- 6 Press .

Checking and canceling waiting jobs

You can check which jobs are still waiting in the memory to be sent and cancel a job. (If there are no jobs, the Touchscreen shows **No Jobs Waiting**.)

- 1 Press .
- 2 Press **All Settings**.
- 3 Swipe up or down, or press **▲** or **▼** to display **Fax**.
- 4 Press **Fax**.
- 5 Swipe up or down, or press **▲** or **▼** to display **Remaining Jobs**.
- 6 Press **Remaining Jobs**. Any waiting jobs appear on the Touchscreen.
- 7 Swipe up or down, or press **▲** or **▼** to scroll through the jobs and press the job you want to cancel. Press **Cancel**.
- 8 Do one of the following:
 - To cancel, press **Yes**.
If you want to cancel another job, go to step 7.
 - To exit without canceling, press **No**.
- 9 When you are finished, press .

Polling



Polling lets you set up your machine so other people can receive faxes from you, but they pay for the call. It also lets you call somebody else's fax machine and receive a fax from it, so you pay for the call. The polling feature needs to be set up on both machines for this to work. Not all fax machines support polling.

Polled Transmit (Black & White only)

Polled Transmit lets you set up your machine to wait with a document so another fax machine can call and retrieve it.

The document will be stored and can be retrieved by any other fax machine until you delete it from the memory. (See *Checking and canceling waiting jobs* on page 20.)

Setting up Polled Transmit

- 1 Load your document.
- 2 Do one of the following:
 - When Fax Preview is set to Off, press  (Fax).
 - When Fax Preview is set to On, press  (Fax) and then  (Sending Faxes).
- 3 Press Options.
- 4 Swipe up or down, or press ▲ or ▼ to display Polled TX.
- 5 Press Polled TX.
- 6 Press On (or Off).
- 7 Press Fax Start.

- 8 If you are using the scanner glass, the Touchscreen will prompt you to choose one of the following options:
 - Press Yes to scan another page. Go to step 9.
 - Press No to store the document in the memory. Other fax machines can now call your machine and retrieve the document.
- 9 Place the next page on the scanner glass and press OK. Repeat steps 8 and 9 for each page. The document will be stored in the memory and wait to be polled.

4

Receiving a fax

Memory Receive (Black & White only)

Memory Receive lets you receive faxes while you are away from the machine.

You can only use one Memory Receive operation at a time:

- Fax Forwarding
- Paging
- Fax Storage
- PC-Fax Receive
- Off

You can change your selection at any time. If received faxes are still in the machine's memory when you change the Memory Receive operation, a message will appear on the Touchscreen. (See *Changing Memory Receive operations* on page 25.)

Fax Forwarding

When you choose **Fax Forward**, your machine stores the received fax in the memory. The machine will then dial the fax number you have programmed and forward the fax message.

- 1 Press .
- 2 Press **All Settings**.
- 3 Swipe up or down, or press ▲ or ▼ to display **Fax**.
- 4 Press **Fax**.
- 5 Swipe up or down, or press ▲ or ▼ to display **Setup Receive**.
- 6 Press **Setup Receive**.

- 7 Swipe up or down, or press ▲ or ▼ to display **Memory Receive**.
- 8 Press **Memory Receive**.
- 9 Swipe up or down, or press ▲ or ▼ to display **Fax Forward**.
- 10 Press **Fax Forward**.
- 11 Enter the forwarding number (up to 20 digits) using the keyboard on the Touchscreen.
Press **OK**.
- 12 If **Fax Preview** is set to **Off**, press **Backup Print: On** or **Backup Print: Off**.

IMPORTANT

- If you choose **Backup Print: On**, the machine will also print the fax at your machine so you will have a copy. This is a safety feature in case there is a power failure before the fax is forwarded or a problem at the receiving machine.
- When you receive a color fax, your machine prints the color fax but does not forward the fax to the Fax Forwarding number you programmed.

- 13 Press .

Paging

When you choose Paging, your machine dials the cell phone or pager number you have programmed. This activates your cell phone or pager so you will know that you have a fax message in the memory.

If you have set Paging, a backup copy of the received fax will be printed at the machine.

- 1 Press .
- 2 Press `All Settings`.
- 3 Swipe up or down, or press `▲` or `▼` to display `Fax`.
- 4 Press `Fax`.
- 5 Swipe up or down, or press `▲` or `▼` to display `Setup Receive`.
- 6 Press `Setup Receive`.
- 7 Swipe up or down, or press `▲` or `▼` to display `Memory Receive`.
- 8 Press `Memory Receive`.
- 9 Swipe up or down, or press `▲` or `▼` to display `Paging`.
- 10 Press `Paging`.
- 11 Enter your cell phone or pager number followed by `##` (up to 20 digits). Press `OK`.
Do not include the area code if it is the same as that of your machine.
For example, press:
1 8 0 0 5 5 5 1 2 3 4 ##.

- 12 Do one of the following:
 - If you are programming your cell phone number and do not need to enter a PIN, press `OK`.
 - If your pager needs a PIN, enter the PIN, press `#`, press `Pause`, and then enter your fax number followed by `##`.

Press `OK`.

For example, press:

1 2 3 4 5 # Pause 1 8 0 0 5 5 5 6 7 8 9 ##

- If you do not need a PIN, press:

`Pause`, and then enter your fax number followed by `##`. Press `OK`.

For example, press:

`Pause 1 8 0 0 5 5 5 6 7 8 9 ##`

- 13 Press .

NOTE

You cannot change a cell phone number, pager number, or PIN remotely.

Fax Storage

If you choose Fax Storage, your machine stores received faxes in the memory. You will be able to retrieve fax messages from another location using the Remote Retrieval commands.

If you have turned on Fax Storage, a backup copy will be printed at the machine.

- 1 Press .
- 2 Press `All Settings`.
- 3 Swipe up or down, or press `▲` or `▼` to display `Fax`.
- 4 Press `Fax`.



- 5 Swipe up or down, or press ▲ or ▼ to display **Setup Receive**.
- 6 Press **Setup Receive**.
- 7 Swipe up or down, or press ▲ or ▼ to display **Memory Receive**.
- 8 Press **Memory Receive**.
- 9 Swipe up or down, or press ▲ or ▼ to display **Fax Storage**.
- 10 Press **Fax Storage**.
- 11 Press .

NOTE

Color faxes cannot be stored in the memory. When you receive a color fax, your machine prints it.

Printing a fax from the memory



If you have chosen **Paging** or **Fax Storage**, you can still print a fax from the memory when you are at your machine. (See *Memory Receive (Black & White only)* on page 22.)

- 1 Press .
- 2 Press **All Settings**.
- 3 Swipe up or down, or press ▲ or ▼ to display **Fax**.
- 4 Press **Fax**.
- 5 Swipe up or down, or press ▲ or ▼ to display **Print Fax**.
- 6 Press **Print Fax**.
- 7 Press **OK**.
- 8 Press .

NOTE

- (When **Fax Preview** is set to **Off**.)
You can also print a fax from the memory by pressing **Print** on the Touchscreen.
- When you print a fax from the memory, the fax data will be erased.

Turning off Memory Receive operations

- 1 Press .
- 2 Press **All Settings**.
- 3 Swipe up or down, or press ▲ or ▼ to display **Fax**.
- 4 Press **Fax**.
- 5 Swipe up or down, or press ▲ or ▼ to display **Setup Receive**.
- 6 Press **Setup Receive**.
- 7 Swipe up or down, or press ▲ or ▼ to display **Memory Receive**.
- 8 Press **Memory Receive**.
- 9 Press **Off**.
- 10 Press .

NOTE

The Touchscreen will show you more options if there are still received faxes in the machine's memory. (See *Changing Memory Receive operations* on page 25.)

Changing Memory Receive operations

If received faxes are in your machine's memory when you change the Memory Receive operations, the Touchscreen will ask you one of the following questions:

If all the received faxes have already been printed

- Erase all faxes?
 - If you press **Yes**, faxes in the memory will be erased before the setting changes.
 - If you press **No**, faxes in the memory will not be erased and the setting will be unchanged.

If unprinted faxes are in the memory

- Print all faxes?
 - If you press **Yes**, faxes in the memory will be printed before the setting changes. If a backup copy has already been printed, it will not be printed again.
 - If you press **No**, faxes in the memory will not be printed and the setting will be unchanged.

If received faxes are left in the machine's memory when you change to **PC Fax Receive** from another option [**Fax Forward**, **Paging** or **Fax Storage**], press **<USB>** or the name of the PC if you are on a network.

Press **OK**.

The Touchscreen will ask you the following question:

- Send Fax to PC?
 - If you press **Yes**, faxes in the memory will be sent to your PC before the setting changes. You will be asked if you want to turn on Backup Print. (See Basic User's Guide: *PC-FAX Receiving (Windows®)*.)
 - If you press **No**, faxes in the memory will not be erased or transferred to your PC and the setting will be unchanged.

Remote Retrieval

You can call your machine from any touch-tone telephone or fax machine and then use the Remote Access Code and remote commands to retrieve fax messages.

Setting a Remote Access Code

The Remote Access Code lets you access the Remote Retrieval features when you are away from your machine. Before you can use the Remote Access and Retrieval features, you have to set up your own code. The factory default code is the inactive code (---*).

- 1 Press .
- 2 Press `All Settings`.
- 3 Swipe up or down, or press ▲ or ▼ to display `Fax`.
- 4 Press `Fax`.
- 5 Swipe up or down, or press ▲ or ▼ to display `Remote Access`.
- 6 Press `Remote Access`.
- 7 Enter a three-digit code using numbers 0 to 9, *, or # using the keyboard on the Touchscreen.
Press `OK`.
(The preset '*' cannot be changed.)

NOTE

Do not use the same code as your Fax Receive Code (* 5 1) or Telephone Answer Code (# 5 1). (See Basic User's Guide: *Using external and extension telephones*.)

- 8 Press .

NOTE

You can change your code at any time by entering a new one. If you want to make your code inactive, press and hold  in step 7 to restore the inactive setting (---*) and press `OK`.

Using your Remote Access Code

- 1 Dial your fax number from a touch-tone telephone or another fax machine.
- 2 When your machine answers, enter your Remote Access Code (3 digits followed by *) at once.
- 3 The machine signals if it has received messages:
 - 1 long beep — Fax messages
 - No beeps — No messages
- 4 When the machine gives two short beeps, enter a command.
The machine will hang up if you wait longer than 30 seconds to enter a command.
The machine will beep three times if you enter an invalid command.
- 5 Press `9 0` to stop Remote Access when you have finished.
- 6 Hang up.

NOTE

- If your machine is set to `Manual` mode and you want to use the Remote Retrieval features, wait for about 100 seconds after it starts ringing, and then enter the Remote Access Code within 30 seconds.
- In some countries this function may not be available or supported by local telephone companies.

Remote Fax commands

Follow the commands in the table to access features when you are away from the machine. When you call the machine and enter your Remote Access Code (3 digits followed by *), the system will give two short beeps and you must enter a remote command.

Remote commands		Operation details
95	Change the Fax Forwarding, Paging or Fax Storage settings	
	1 OFF	You can choose OFF after you have retrieved or erased all your messages.
	2 Fax Forwarding	One long beep means the change is accepted. If you hear three short beeps, you cannot make a change because something has not been set up (for example, a Fax Forwarding or Paging number has not been registered).
	3 Paging	
	4 Fax Forwarding number	
6 Fax Storage	You can register your Fax Forwarding number by entering 4. (See <i>Changing your Fax Forwarding number</i> on page 28.) Once you have registered the number, Fax Forwarding will work.	
96	Retrieve a fax	
	2 Retrieve all faxes	Enter the number of a remote fax machine to receive stored fax messages. (See <i>Retrieving fax messages</i> on page 28.)
	3 Erase faxes from the memory	If you hear one long beep, fax messages have been erased from the memory.
97	Check the receiving status	
	1 Fax	You can check whether your machine has received any faxes. If yes, you will hear one long beep. If no, you will hear three short beeps.
98	Change the Receive Mode	
	1 External TAD	If you hear one long beep, your change has been accepted.
	2 Fax/Tel	
	3 Fax Only	
90	Exit	Pressing 9 0 allows you to exit Remote Retrieval. Wait for the long beep, then replace the handset.

Retrieving fax messages

You can call your machine from any touch-tone telephone and have your fax messages sent to another machine. Before you use this feature, you have to turn on Fax Storage or Fax Preview. (See *Fax Storage* on page 23 or see *Basic User's Guide: Fax Preview (Black & White only)*.)

- 1 Dial your fax number.
- 2 When your machine answers, enter your Remote Access Code (3 digits followed by *) at once. If you hear one long beep, you have messages.
- 3 When you hear two short beeps, press **9 6 2**.
- 4 Wait for a long beep, and then use the dial pad to enter the number of the remote fax machine where you want your fax messages sent, followed by **# #** (up to 20 digits).

NOTE

You cannot use * and # as dial numbers. However, press # if you want to create a pause.

- 5 Hang up after you hear your machine beep. Your machine will call the other fax machine, which will then print your fax messages.

Changing your Fax Forwarding number

You can change the default setting of your Fax Forwarding number from another touch-tone telephone or fax machine.

- 1 Dial your fax number.
- 2 When your machine answers, enter your Remote Access Code (3 digits followed by *) at once. If you hear one long beep, you have messages.
- 3 When you hear two short beeps, press **9 5 4**.
- 4 Wait for the long beep, enter the new number (up to 20 digits) of the remote fax machine you want your fax messages forwarded to using the dial pad, then enter **# #**.

NOTE

You cannot use * and # as dial numbers. However, press # if you want to create a pause.

- 5 Press **9 0** to stop Remote Access when you have finished.
- 6 Hang up after you hear your machine beep.

Additional receiving operations

Receiving faxes into memory when paper tray is empty

As soon as the paper tray becomes empty during fax reception, the Touchscreen shows **No Paper Fed**. Put some paper in the paper tray. (See Basic User's Guide: *Loading paper and other print media*.)

If you don't put paper in the paper tray, the machine will continue receiving the fax, with the remaining pages being stored in the memory, if enough memory is available.

When the memory is full, the machine will stop answering calls. To print the faxes, put fresh paper in the tray.

Printing a reduced incoming fax

If you choose **On**, the machine reduces each page of an incoming fax to fit on one sheet of Letter, Legal, Ledger, A4 or A3 size paper. The machine calculates the reduction ratio by using the page size of the fax and your Paper Size setting.

(See Basic User's Guide: *Paper Size and Type*.)

- 1 Press .
- 2 Press **All Settings**.
- 3 Swipe up or down, or press ▲ or ▼ to display **Fax**.
- 4 Press **Fax**.
- 5 Swipe up or down, or press ▲ or ▼ to display **Setup Receive**.
- 6 Press **Setup Receive**.

- 7 Swipe up or down, or press ▲ or ▼ to display **Auto Reduction**.
- 8 Press **Auto Reduction**.
- 9 Press **On (or Off)**.
- 10 Press .

Receiving a fax at the end of a conversation

At the end of a conversation, you can ask the other party to fax you information before you both hang up. Make sure the ADF is empty.

- 1 Ask the other party to place the document in their machine and to press the **Start** or **Send** key.
- 2 When you hear the other machine's CNG tones (slowly repeating beeps), press **Fax Start**.

NOTE

If the Touchscreen is dark for Sleep mode, touch it to display **Fax Start**.

- 3 Press **Receive** to receive the fax.
- 4 Replace the handset of the external telephone.



Polling

Polling lets you set up your machine so other people can receive faxes from you, but they pay for the call. It also lets you call somebody else's fax machine and receive a fax from it, so you pay for the call. The polling feature needs to be set up on both machines for this to work. Not all fax machines support polling.

Polling receive



Polling receive lets you call another fax machine to receive a fax.

Setup to receive polling

- 1 Do one of the following:
 - When Fax Preview is set to *Off*, press  (Fax).
 - When Fax Preview is set to *On*, press  (Fax) and then  (Sending Faxes).
- 2 Press *Options*.
- 3 Swipe up or down, or press ▲ or ▼ to display *Polling RX*.
- 4 Press *Polling RX*.
- 5 Press *On* (or *Off*).
- 6 Enter the fax number you are polling using *Address Book* or the dial pad on the *Touchpanel*.
- 7 Press *Fax Start*.
The *Touchscreen* shows *Dialing*.

Sequential polling (Black & White only)

Sequential polling lets you request documents from several fax machines in one operation. Afterwards, a *Sequential Polling Report* will be printed.

- 1 Do one of the following:
 - When Fax Preview is set to *Off*, press  (Fax).
 - When Fax Preview is set to *On*, press  (Fax) and then  (Sending Faxes).
- 2 Press *Options*.
- 3 Swipe up or down, or press ▲ or ▼ to display *Polling RX*.
- 4 Press *Polling RX*.
- 5 Press *On* (or *Off*).
- 6 Press *Options*. Swipe up or down, or press ▲ or ▼ to display *Broadcasting*.
- 7 Press *Broadcasting*.
- 8 Press *Add Number*.

9 You can add numbers to the broadcast in the following ways:

- Press `Add Number` and enter a number using the keyboard on the Touchscreen.
Press `OK`.
- Press `Add from Address book`.
Swipe up or down, or press `▲` or `▼` to display the number you want to add to the broadcast.
Press the check boxes of the numbers you want to add to the broadcast.
After you have checked all the numbers you want, press `OK`.
- Press `Search in Address book`.
Enter the first letter of the name and press `OK`.
Press the name, and then press the number you want to add to the broadcast.



10 After you have entered all the fax numbers by repeating steps 8 and 9, press `OK`.

11 Press `Fax Start`.
The machine polls each number or Group number in turn for a document.

Press  while the machine is dialing to cancel the polling process.

To cancel all sequential polling receive jobs, see *Canceling a Sequential Polling Job* on page 31.

Canceling a Sequential Polling Job



- 1 Press .
- 2 Do one of the following:
 - To cancel the entire sequential polling job, press `Entire Seq. Poll`. Go to step 3.
 - To cancel the current job, press the name or number being dialed on the Touchscreen. Go to step 4.
 - To exit without canceling, press .
- 3 When the Touchscreen asks if you want to cancel the entire sequential polling job, do one of the following:
 - Press `Yes` to confirm.
 - To exit without canceling, press `No`.
- 4 Do one of the following:
 - To cancel the current job, press `Yes`.
 - To exit without canceling, press `No`.

Voice operations

You can use your external telephone to dial voice calls.

Tone or Pulse (Canada only)

If you have a Pulse dialing service, but need to send tone signals (for example, for telephone banking), follow the instructions below:

- 1 Do one of the following:
 - When Fax Preview is set to `Off`, press  (Fax).
 - When Fax Preview is set to `On`, press  (Fax) and then  (Sending Faxes).
- 2 Press `Hook`.
- 3 Press `#` on the machine's Touchpanel. Any digits dialed after this will send tone signals.

When you are finished with the call, the machine will return to the Pulse dialing service.

Fax/Tel mode

When the machine is in Fax/Tel mode, it will use the F/T Ring (pseudo/double-ringing) to alert you to pick up a voice call.

If you are at the extension telephone, you'll need to lift the handset during the F/T Ring and then press `# 5 1` between the pseudo/double-rings. If no one is on the line, or if someone wants to send you a fax, send the call back to the machine by pressing `* 5 1`.

If you are at the machine, lift the external telephone's handset, and then press `Pickup` to answer.

Caller ID

The Caller ID feature lets you use the Caller ID subscriber service offered by many local telephone companies. This service shows the telephone number or name (if available) of your caller as the line rings. Call your telephone company for details.

Once you answer a call, the Caller ID information disappears from the Touchscreen, but the call information stays stored in the Caller ID memory.

You can view the list or choose one of these numbers to fax to, add to Address Book, or delete from the history. (See *Caller ID history* on page 35.)

- You can see the number (or name).
- The `# Unavailable` message means the call originated outside your Caller ID service area.
- The `Private Call` message means the caller has intentionally blocked transmission of Caller ID information.



You can print a list of the Caller ID information received by your machine. (See *How to print a report* on page 41.)

NOTE

- This feature may not be available in certain areas of the USA and Canada.
- The Caller ID service varies with different carriers. Call your local telephone company to find out about the kind of service available in your area.

Setting up your area code (USA only)

When returning calls from the Caller ID history, your machine will dial “1” plus the area code for all calls. If your local dialing plan requires that “1” not be dialed for calls within your area code, enter your area code in this setting. With the area code setting, calls returned from the Caller ID history to numbers *within* your area code will be dialed using 10 digits (area code + 7-digit number). If your dialing plan does not follow the standard 1 + area code + 7-digit number dialing system for calling *outside* your area code, you may experience problems automatically returning calls from the Caller ID history. If this is not the procedure followed by your dialing plan, you will not be able to automatically return calls.

- 1 Press .
- 2 Press **All Settings**.
- 3 Swipe up or down, or press ▲ or ▼ to display **Fax**.
- 4 Press **Fax**.
- 5 Swipe up or down, or press ▲ or ▼ to display **Miscellaneous**.
- 6 Press **Miscellaneous**.
- 7 Press **Area Code**.
- 8 Enter your Area Code (3-digit number), and press **OK**.
- 9 Press .

Special line considerations**Roll-over telephone lines**

A roll-over telephone system is a group of two or more separate telephone lines that pass incoming calls to each other if they are busy. The calls are usually passed down or “rolled over” to the next available telephone line in a preset order.

Your machine can work in a roll-over system as long as it is the last number in the sequence so the call cannot roll away. Do not put the machine on any of the other numbers; when the other lines are busy and a second fax call is received, the fax call will be sent to a line that does not have a fax machine. **Your machine will work best on a dedicated line.**

Two-line telephone system

A two-line telephone system is nothing more than two separate telephone numbers on the same wall outlet. The two telephone numbers can be on separate jacks (RJ11) or mixed into one jack (RJ14). Your machine must be plugged into an RJ11 jack. RJ11 and RJ14 jacks may be equal in size and appearance and both may contain four wires (black, red, green and yellow). To test the type of jack, plug in a two-line telephone and see if it can access both lines. If it can, you must separate the line for your machine.

Converting telephone wall outlets

There are three ways to convert to an RJ11 jack. The first two ways may require help from the telephone company. You can change the wall outlets from one RJ14 jack to two RJ11 jacks. Or, you can have an RJ11 wall outlet installed and slave or jump one of the telephone numbers to it.

The third way is the easiest: Buy a triplex adapter. You can plug a triplex adapter into an RJ14 outlet. It separates the wires into two separate RJ11 jacks (Line 1, Line 2) and a third RJ14 jack (Lines 1 and 2). If your machine is on Line 1, plug the machine into L1 of the triplex adapter. If your machine is on Line 2, plug it into L2 of the triplex adapter.

Triplex Adapter

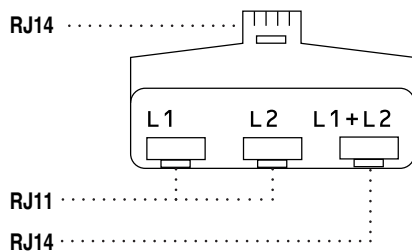

Installing machine, external two-line TAD and two-line telephone

When you are installing an external two-line telephone answering device (TAD) and a two-line telephone, your machine must be isolated on one line at both the wall jack and at the TAD. The most common connection is to put the machine on Line 2, which is explained in the following steps. The back of the two-line TAD must have two telephone jacks: one labeled L1 or L1/L2, and the other labeled L2. You will need at least three telephone line cords: the one that came with your machine and two for your external two-line TAD. You will need a fourth line cord if you add a two-line telephone.

- 1 Put the two-line TAD and the two-line telephone next to your machine.

- 2 Plug one end of the telephone line cord for your machine into the L2 jack of the triplex adapter. Plug the other end into the LINE jack inside the machine.
- 3 Plug one end of the first telephone line cord for your TAD into the L1 jack of the triplex adapter. Plug the other end into the L1 or L1/L2 jack of the two-line TAD.
- 4 Plug one end of the second telephone line cord for your TAD into the L2 jack of the two-line TAD. Plug the other end into the EXT. jack inside the machine.

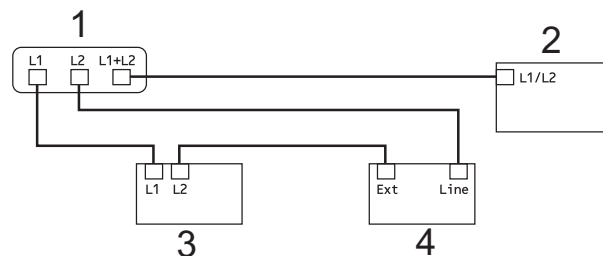



- 1 Triplex Adapter
- 2 Two-Line Telephone
- 3 External Two-Line TAD
- 4 Machine

Your additional two-line telephones on other wall outlets do not require adapters. There are two ways to add a two-line telephone to the machine's wall outlet. You can plug the telephone line cord from the two-line telephone into the L1+L2 jack of the triplex adapter. Or, you can plug the two-line telephone into the TEL jack of the two-line TAD.

Additional dialing operations

Outgoing Call History

The last 30 numbers you sent a fax to will be stored in the Outgoing Call history. You can choose one of these numbers to fax to, add to Address Book, or delete from the history.

- 1 Press  (Fax).
- 2 Press  (Call History).
- 3 Press *Outgoing Call*.
- 4 Press the number you want.
- 5 Do one of the following:
 - To send a fax, press *Apply*.
Press *Fax Start*.
 - If you want to store the number, press *Edit* and then press *Add to Address Book*.
(See Storing Address Book numbers from the Outgoing Call history on page 37.)
 - If you want to delete the number from the Outgoing Call history list, press *Edit* and then press *Delete*.
Press *Yes* to confirm.
Press .



Caller ID history

This feature requires the Caller ID subscriber service offered by many local telephone companies. (See *Caller ID* on page 32.)

The numbers or names (if available) from the last 30 faxes and telephone calls you received will be stored in the Caller ID history. You can view the list or choose one of these numbers to fax to, add to the Address Book, or delete from the history. When the thirty-first call comes into the machine, it replaces information about the first call.

NOTE

If you are not a Caller ID subscriber, Caller ID history only allows you to view and delete the dates of calls.

- 1 Press  (Fax).
- 2 Press  (Call History).
- 3 Press *Caller ID history*.
- 4 Press the number or the name you want.
- 5 Do one of the following:
 - To send a fax, press *Apply*.
Press *Fax Start*.
 - If you want to store the number, press *Edit* and then press *Add to Address Book*.
(See Storing Address Book numbers from the Caller ID history on page 37.)
 - If you want to delete the number from the Caller ID history list, press *Edit* and then press *Delete*.
Press *Yes* to confirm.
Press .

NOTE

- (USA only) If you redial from the Caller ID history outside your area code, you must set up your area code in advance. (See *Setting up your area code (USA only)* on page 33.)
- You can print the Caller ID history List. (See *How to print a report* on page 41.)



Dialing access codes and credit card numbers

Sometimes, you may want to choose from several long-distance carriers when you send a fax. Rates may vary depending on the time and destination. To take advantage of low rates, you can store the access codes of long-distance carriers and credit card numbers as Address Book numbers. (See Basic User's Guide: *Storing Address Book numbers.*)

You can store these long dialing sequences by dividing them and setting them up as separate Address Book numbers in any combination.

You can even include manual dialing using the dial pad.

For example, you might have stored '555' on Address Book: Brother 1 and '7000' on Address Book: Brother 2. You can use them both to dial '555-7000' as shown in the following example:

- 1 Press  (Fax).
- 2 Press  (Address Book).
- 3 Swipe up or down, or press ▲ or ▼ to display the number of Brother 1.
- 4 Press the number.
- 5 Press `Apply`.
- 6 Press `Address Book`.

- 7 Swipe up or down, or press ▲ or ▼ to display the number of Brother 2.
- 8 Press the number.
- 9 Press `Apply`.
- 10 Press `Fax Start`.
You will dial '555-7000'.

To temporarily change a number, you can substitute part of the number with manual dialing using the dial pad. For example, to change the number to 555-7001, you could enter the number (Brother 1: 555) using

 (`Address Book`), press `Apply`, and then press **7001** using the dial pad.



NOTE

If you must wait for another dial tone or signal at any point in the dialing sequence, create a pause in the number by pressing `Pause`. Each key press adds a 3.5-second delay. You can press `Pause` as many times as needed to increase the length of the pause.

Additional ways to store numbers



Storing Address Book numbers from the Outgoing Call history

You can also store Address Book numbers from the Outgoing Call history.

- 1 Press  (Fax).
- 2 Press  (Call History).
- 3 Press **Outgoing Call**.
- 4 Swipe up or down, or press ▲ or ▼ to display the number you want to store.
- 5 Press the number you want to store.
- 6 Press **Edit**.
- 7 Press **Add to Address Book**.
- 8 Press **Name**.
- 9 Enter the name (up to 16 characters) using the keyboard on the Touchscreen. Press **OK**.
(For help entering letters, see Basic User's Guide: *Entering Text*.)
- 10 If you want to store a second fax or telephone number, press **Address 2**. Enter the second fax or telephone number using the keyboard on the Touchscreen (up to 20 digits). Press **OK**.
- 11 Press **OK** to confirm the fax or telephone number you want to store.
- 12 Press .

Storing Address Book numbers from the Caller ID history

If you have the Caller ID subscriber service from your telephone company, you can also store Address Book numbers from incoming calls in the Caller ID history. (See *Caller ID* on page 32.)

- 1 Press  (Fax).
- 2 Press  (Call History).
- 3 Press **Caller ID history**.
- 4 Swipe up or down, or press ▲ or ▼ to display the name or number you want to store.
- 5 Press the name or number you want to store.
- 6 Press **Edit**.
- 7 Press **Add to Address Book**.
- 8 Press **Name**.
- 9 Enter the name (up to 16 characters) using the keyboard on the Touchscreen. Press **OK**.
(For help entering letters, see Basic User's Guide: *Entering Text*.)
- 10 If you want to store a second fax or telephone number, press **Address 2**. Enter the second fax or telephone number using the keyboard on the Touchscreen (up to 20 digits). Press **OK**.
- 11 Press **OK** to confirm the fax or telephone number you want to store.
- 12 Press .



Setting up Groups for Broadcasting

A Group, which is stored in the Address Book, allows you to send the same fax message to many fax numbers by pressing  (Fax),

 (Address Book), Apply and Fax Start.

(See *Broadcasting (Black & White only)* on page 16.)

First, you'll need to store each fax number in the Address Book. (See Basic User's Guide: *Storing Address Book numbers.*) Then you can include them as numbers in the Group. Each Group uses up an Address Book number. You can have up to six Groups, or you can assign up to 198 numbers to a large Group.



- 1 Press  (Fax).
- 2 Press  (Address Book).
- 3 Press `Edit`.
- 4 Press `Setup Groups`.
- 5 Press `Name`.
- 6 Enter the Group name (up to 16 characters) using the keyboard on the Touchscreen.
Press `OK`.
- 7 Press `Add/Delete`.
- 8 Add Address Book numbers to the Group by pressing them to display a red check mark. Press `OK`.
- 9 Read and confirm the displayed list of names and numbers you have chosen, and then press `OK` to save your Group.

- 10 Do one of the following:
 - To store another Group for broadcasting, repeat steps 3 to 9.
 - To finish storing Groups for broadcasting, press .

NOTE

You can print a list of all the Address Book numbers. (See *Reports* on page 41.)

Changing a Group name

- 1 Press  (Fax).
- 2 Press  (Address Book).
- 3 Press `Edit`.
- 4 Press `Change`.
- 5 Swipe up or down, or press `▲` or `▼` to display the Group you want to change.
- 6 Press the Group.
- 7 Press `Name`.
- 8 Enter the new name (up to 16 characters) using the keyboard on the Touchscreen.
Press `OK`.
(For example, type NEW CLIENTS.)

NOTE



How to change the stored name:

If you want to change a character, press `◀` or `▶` to position the cursor to highlight the character you want to change, and then press . Enter the new character.



(For help entering letters, see Basic User's Guide: *Entering Text.*)

- 9 Press `OK`.
- 10 Press .

Deleting a Group

- 1 Press  (Fax).
- 2 Press  (Address Book).
- 3 Press **Edit**.
- 4 Press **Delete**.
- 5 Swipe up or down, or press ▲ or ▼ to display the Group you want to delete.
- 6 Press the Group name to add a check mark.
- 7 Press **OK**.
Press **Yes** to confirm.
- 8 Press .

Adding or Deleting a number in a Group

- 1 Press  (Fax).
- 2 Press  (Address Book).
- 3 Press **Edit**.
- 4 Press **Change**.
- 5 Swipe up or down, or press ▲ or ▼ to display the Group you want to change.
- 6 Press the Group.
- 7 Swipe up or down, or press ▲ or ▼ to display **Add/Delete**.
- 8 Press **Add/Delete**.
- 9 Swipe up or down, or press ▲ or ▼ to display the number you want to add or delete.
- 10 Do the following for each number you want to change:
 - To add a number to the Group, press the check box of the number to *add* a check mark.
 - To delete a number from the Group, press the check box of the number to *remove* the check mark.
 Press **OK** to confirm all your changes.
- 11 Press **OK**.
- 12 Press .

6

Printing reports

Fax reports

Press  on the Touchscreen to set up the Transmission Verification Report and the Journal Period.

Transmission Verification Report

You can use the Transmission Verification Report as proof that you sent a fax. (See Basic User's Guide: *Transmission Verification Report*.)

Fax Journal (activity report)

You can set the machine to print the Fax Journal report at specific intervals (every 50 faxes, 6, 12 or 24 hours, 2 or 7 days). If you set the interval to **OFF**, you can still print the report by following the steps in *How to print a report* on page 41. The factory setting is **Every 50 Faxes**.

- 1 Press .
- 2 Press **All Settings**.
- 3 Swipe up or down, or press ▲ or ▼ to display **Fax**.
- 4 Press **Fax**.
- 5 Swipe up or down, or press ▲ or ▼ to display **Report Setting**.
- 6 Press **Report Setting**.
- 7 Press **Journal Period**.
- 8 Press **Journal Period**.

- 9 Swipe up or down, or press ▲ or ▼ to choose an interval.
If you choose **Every 50 Faxes**, go to step 10.

- **6, 12, 24 hours, 2 or 7 days**

The machine will print the report at the chosen time and then erase all jobs from its memory. If the machine's memory becomes full with 200 jobs before the time you chose has passed, the machine will print the Fax Journal report early and then erase all jobs from the memory. If you want an extra report before it is due to print, you can print it without erasing the jobs from the memory.

- **Every 50 Faxes**

The machine will print the Fax Journal report when the machine has stored 50 jobs.

- 10 To enter the time to start printing, do one of the following:

- If you have set **12h Clock** in the **Clock Type** setting, press **Time** and enter the time (in 12-hour format) by pressing the keyboard on the Touchscreen, and then press **AM** or **PM**.

Press **OK**.

- If you have set **24h Clock** in the **Clock Type** setting, press **Time** and enter the time (in 24-hour format) by pressing the keyboard on the Touchscreen.

Press **OK**.

(For example: enter 19:45 for 7:45 PM.)

- 11 If you chose **Every 7 Days**, press **Day**.

12 Swipe up or down, or press ▲ or ▼ to display Every Monday, Every Tuesday, Every Wednesday, Every Thursday, Every Friday, Every Saturday OR Every Sunday, and then press the first day for the 7-day countdown.

13 Press .

Reports

The following reports are available:

- **Transmission**
Prints a Transmission Verification Report for your last transmission.
- **Address Book**
Prints a list of names and numbers stored in the Address Book memory, in alphabetical order.
- **Fax Journal**
Prints a list of information about the last incoming and outgoing faxes. (TX: Transmit.) (RX: Receive.)
- **User Settings**
Prints a list of your settings.
- **Network Configuration**
Prints a list of your Network settings.
- **WLAN Report**
Prints the result of the WLAN connection.
- **Caller ID history**
Prints a list of the available Caller ID information about the last 30 received faxes and telephone calls.

How to print a report

- 1 Press .
- 2 Press All Settings.
- 3 Swipe up or down, or press ▲ or ▼ to display Print Reports.
- 4 Press Print Reports.
- 5 Press the report you want to print.
- 6 Press OK.
- 7 Press .

7

Making copies

Copy options

You can change the copy settings for the next copy.

These settings are temporary. The machine returns to its default settings 1 minute after copying.

Press **Copy**, and then press **Options**. Swipe up or down, or press **▲** or **▼** to scroll through the copy settings. When the setting you want is displayed, press it and choose your preferred option.

When you have finished changing the options, press **OK**, and then press **Black Start** or **Color Start**.

NOTE

- You can save some of the options you use most often by setting them as a **Shortcut**. (See *Saving copy options as a Shortcut* on page 55.)
- The **Ink Save Mode**, **Thin Paper Copy**, **Book Copy** and **Watermark Copy** features are supported by technology from Reallusion,

Inc.  **REALLUSION**

Stop copying

To stop copying, press .

Improving copy quality

You can choose the copy quality. The factory setting is **Normal**.

NOTE

If you choose **Normal**, you can only choose **Plain Paper** in **Paper Type**.

■ Normal

Normal is the recommended mode for ordinary printouts. This produces good copy quality with good copy speed.



■ Best

Use **Best** mode to copy precise images, such as photographs. This provides the highest resolution and slowest speed.

- 1 Load your document.
- 2 Press  (**Copy**).
- 3 Enter the number of copies you want.
- 4 Press **Options**.
- 5 Swipe up or down, or press **▲** or **▼** to display **Quality**.
- 6 Press **Quality**.
- 7 Press **Normal** or **Best**.
- 8 Press **OK**.
- 9 If you do not want to change additional settings, press **Black Start** or **Color Start**.

Enlarging or reducing copies

You can choose an enlargement or reduction ratio. If you choose **Fit to Page**, your machine will adjust the size to the paper size you set.

- 1 Load your document.
- 2 Press  (Copy).
- 3 Enter the number of copies you want.
- 4 Press **Options**.
- 5 Swipe up or down, or press **▲** or **▼** to display **Enlarge/Reduce**.
- 6 Press **Enlarge/Reduce**.
- 7 Swipe up or down, or press **▲** or **▼** to display the available options, and then press the option you want to change.
- 8 Do one of the following:
 - If you chose **Enlarge** or **Reduce**, press the enlargement or reduction ratio you want to use.
 - If you chose **Custom (25-400%)**, press  to erase the displayed percentage, or press **◀** to move the cursor, and then enter an enlargement or reduction ratio from 25% to 400%.
Press **OK**.
 - If you chose **100%** or **Fit to Page**, go to step 9.

198% 4"x6" → A4
186% 4"x6" → Letter
130% Letter → Ledger
104% EXE → Letter
100%
97% Letter → A4
93% A4 → Letter
85% Letter → EXE
83% Legal → A4
78% Legal → Letter
64% Ledger → Letter
46% Letter → 4"x6"
Fit to Page
Custom (25-400%)

- 9 Read and confirm the displayed list of options you have chosen, and then press **OK**.
- 10 If you do not want to change additional settings, press **Black Start** or **Color Start**.

NOTE

- Page Layout is not available with Enlarge/Reduce.
- ADF High Speed Mode, Page Layout, 2-sided→2-sided and 1-sided→2-sided of 2-sided Copy, Book Copy, Sort, Thin Paper Copy, Watermark Copy and Remove Background Color are not available with Fit to Page.
- Fit to Page does not work correctly when the document on the scanner glass or ADF is skewed more than 3 degrees.

(If you are using the scanner glass)

Using the document guidelines on the left and top, place your document in the upper-left corner, with the document face down on the scanner glass.

(If you are using the ADF)

Place your document, face up, short edge first in the ADF until the Touchscreen shows ADF Ready. and you feel the pages touch the feed rollers. Adjust the paper guides so they touch the sides of the document.

- Fit to Page is not available for Legal size documents.

Making N in 1 copies or a poster (Page Layout)

The N in 1 copy feature can help you save paper by letting you copy two or four pages onto one printed page.

The 1to2 feature copies one Ledger or A3 size page onto two Letter or A4 size pages. If you use this setting, use the scanner glass.

You can also produce a poster. When you use the poster feature, your machine divides your document into sections, then enlarges the sections so you can assemble them into a poster. If you want to print a poster, use the scanner glass.

NOTE

- ADF High Speed Mode, Book Copy, Sort, Thin Paper Copy, Ink Save Mode, Enlarge/Reduce, Watermark Copy and Remove Background Color are not available with Page Layout.
- Auto Deskew is not available with Poster and 1 to 2 copy.
- 2-sided Copy is not available with Poster copy.

- 1 Load your document.
- 2 Press  (Copy).
- 3 Enter the number of copies you want. ¹

¹ You can only make one copy at a time when you are using Poster layout.
- 4 Press Options.
- 5 Swipe up or down, or press ▲ or ▼ to display Page Layout.
- 6 Press Page Layout.

- 7** Swipe up or down, or press ▲ or ▼ to display Off (1in1), 2in1 (Portrait), 2in1 (Landscape), 2in1 (ID) ¹, 4in1 (Portrait), 4in1 (Landscape), 1to2, Poster (2x1), Poster (2x2) or Poster (3x3).
Press the option you want to set.

¹ For details about 2 in 1 (ID), see *2 in 1 ID Copy (Page Layout)* on page 47.

If you chose 2in1 or Poster (2x2) with Ledger or A3 size paper, go to step **8** to choose your Layout Format.
If you choose another setting, go to step **9**.

- 8** Press `Layout Format`.
Do one of the following:
- If you chose 2in1 (Portrait) or 2in1 (Landscape), press `Letterx2 → Ledgerx1`, `Ledgerx2 → Ledgerx1`, `A4x2 → A3x1`, or `A3x2 → A3x1`.
 - If you chose Poster (2x2), press `Letterx1 → Ledgerx4`, `Ledgerx1 → Ledgerx4`, `A4x1 → A3x4`, or `A3x1 → A3x4`.

- 9** Read and confirm the displayed list of settings you have chosen, and then press `OK`.
- 10** If you do not want to change additional settings, press `Black Start` or `Color Start` to scan the page.
If you placed the document in the ADF or are making a poster, the machine scans the pages and starts printing.
- If you are using the scanner glass, go to step **11**.**
- 11** After the machine has scanned the page, press `Yes` to scan the next page.

- 12** Place the next page on the scanner glass. Press `OK` to scan the page.
Repeat steps **11** and **12** for each page of the layout.
- 13** After all the pages have been scanned, press `No` to finish.

NOTE

- Make sure the paper size is set to Letter, Ledger, A4, A3, or Executive.
- Poster copy is not available for Executive size paper.
- You can only make one color copy at a time.
- You can only make one Poster and 1 to 2 copy at a time.
- Poster copy is not available when using transparencies.

If you are copying from the ADF, insert the document face up in the direction shown below:

■ 2in1 (Portrait)



■ 2in1 (Landscape)



■ 4in1 (Portrait)

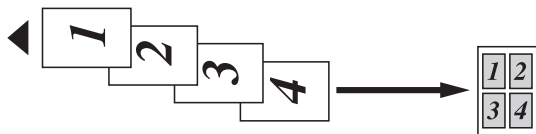

■ 4in1 (Landscape)



If you are copying from the scanner glass, place the document face down in the direction shown below:

■ 2in1 (Portrait)



■ 2in1 (Landscape)

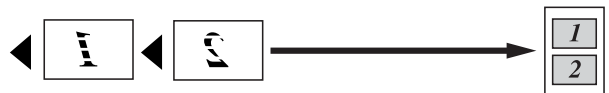

■ 4in1 (Portrait)



■ 4in1 (Landscape)



■ 1to2



■ **Poster (2x1)**

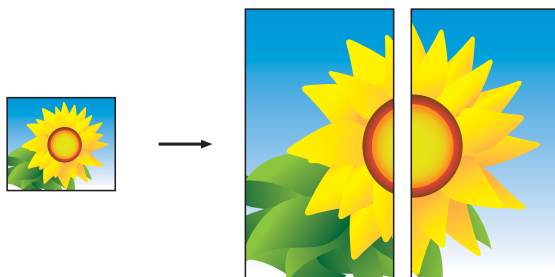

■ **Poster (2x2)**

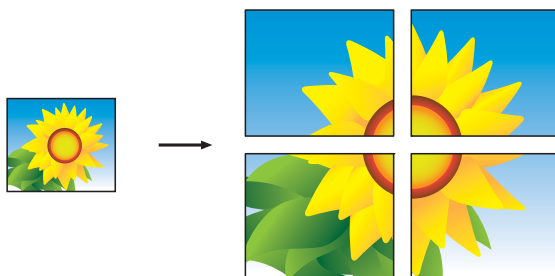

■ **Poster (3x3)**

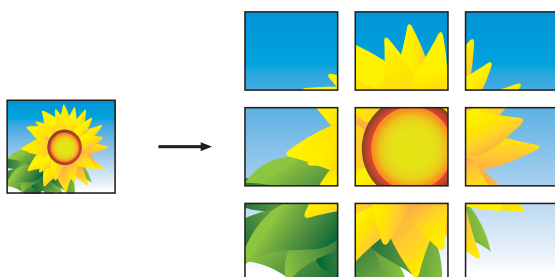

NOTE

The poster copies have overlapping portions so that you can easily paste them together.

2 in 1 ID Copy (Page Layout)

You can copy both sides of your identification card onto one page, keeping the original card size. Make sure the paper size is set to Letter or A4.

NOTE

You can copy an identification card to the extent permitted under applicable laws. (See Product Safety Guide: *Legal limitations for copying.*)

- 1 Place your identification card *face down* near the left corner of the scanner glass as shown in the illustration.

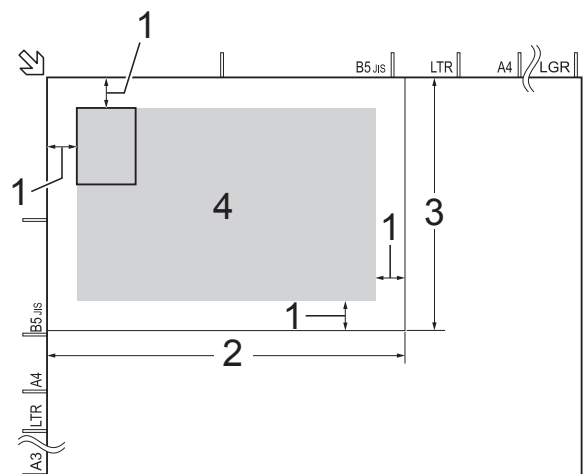

- 1 0.12 in. (3 mm) or greater (top, left)
- 2 8.5 in. (216 mm)
- 3 5.5 in. (140 mm)
- 4 scannable area

- 2 Press  (Copy).
- 3 Enter the number of copies you want.
- 4 Press *Options*.
- 5 Swipe up or down, or press ▲ or ▼ to display *Page Layout*.
- 6 Press *Page Layout*.

- 7 Swipe up or down, or press ▲ or ▼ to display 2in1 (ID).
- 8 Press 2in1 (ID).
- 9 Read and confirm the displayed list of settings you have chosen, and then press OK.
- 10 Press Black Start or Color Start. The machine starts scanning one side of the identification card.
- 11 After the machine has scanned the first side, press Yes. Turn over the identification card and press OK to scan the other side.

NOTE

- ADF High Speed Mode, Book Copy, Sort, 2-sided Copy, Thin Paper Copy, Ink Save Mode, Enlarge/Reduce, Watermark Copy and Remove Background Color are not available with 2in1 (ID).
- You can only make one color copy at a time.

Sorting copies using the ADF

You can sort multiple copies. Pages will be stacked in the order 321, 321, 321, and so on.

- 1 Load your document.
- 2 Press  (Copy).
- 3 Enter the number of copies you want.
- 4 Press Options.
- 5 Swipe up or down, or press ▲ or ▼ to display Stack/Sort.
- 6 Press Stack/Sort.
- 7 Press Sort.

- 8 Read and confirm the displayed list of settings you have chosen, and then press OK.
- 9 If you do not want to change additional settings, press Black Start or Color Start.

NOTE

Fit to Page, Page Layout and Book Copy are not available with Sort.

Adjusting Density

You can adjust the copy density to make copies darker or lighter.

- 1 Load your document.
- 2 Press  (Copy).
- 3 Enter the number of copies you want.
- 4 Press Options.
- 5 Swipe up or down, or press ▲ or ▼ to display Density.
- 6 Press Density.
- 7 Press the level of density you want, from Light to Dark.
- 8 Read and confirm the displayed list of settings you have chosen, and then press OK.
- 9 If you do not want to change additional settings, press Black Start or Color Start.

Ink Save Mode

Ink Save Mode can help you save some ink. Your machine detects the edges of the image and prints the outline of the image.

The amount of ink saved will vary depending on the document.

Ink Save Mode: Off



Ink Save Mode: On

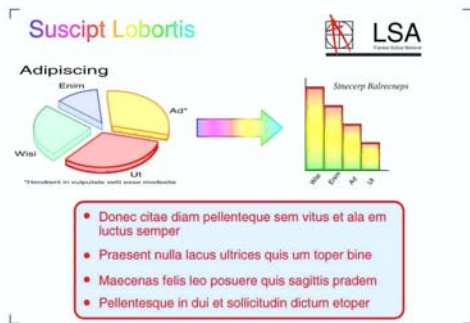

(The above screens are used in ISO/IEC 24712.)

- 1 Load your document.
- 2 Press  (Copy).
- 3 Enter the number of copies you want.
- 4 Press Options.
- 5 Swipe up or down, or press ▲ or ▼ to display Advanced Settings.
- 6 Press Advanced Settings.

- 7 Swipe up or down, or press ▲ or ▼ to display Ink Save Mode.
- 8 Press Ink Save Mode.
- 9 Read and confirm the displayed list of settings you have chosen, and then press OK.
- 10 If you do not want to change any additional settings, press Black Start or Color Start.

NOTE

- ADF High Speed Mode, Book Copy, Thin Paper Copy, Auto Deskew, Page Layout, Watermark Copy and Remove Background Color are not available with Ink Save Mode.
- Ink Save Mode may make your printouts look different from your original document.

Thin Paper Copy

If your document is a 2-sided Copy on thin paper, choose **Thin Paper Copy** so the print on the other side does not bleed through.

- 1 Load your document.
- 2 Press  (Copy).
- 3 Enter the number of copies you want.
- 4 Press **Options**.
- 5 Swipe up or down, or press ▲ or ▼ to display **Advanced Settings**.
- 6 Press **Advanced Settings**.
- 7 Swipe up or down, or press ▲ or ▼ to display **Thin Paper Copy**.
- 8 Press **Thin Paper Copy**.
- 9 Read and confirm the displayed list of settings you have chosen, and then press **OK**.
- 10 Press **Black Start** or **Color Start**.

NOTE

ADF High Speed Mode, Fit to Page, Page Layout, Auto Deskew, Ink Save Mode, Book Copy, Watermark Copy and Remove Background Color are not available with **Thin Paper Copy**.

Auto Deskew

If your scanned copy is skewed, your machine can correct the data automatically.

This setting is only available when using the scanner glass.

- 1 Load your document.
- 2 Press  (Copy).
- 3 Enter the number of copies you want.
- 4 Press **Options**.
- 5 Swipe up or down, or press ▲ or ▼ to display **Auto Deskew**.
- 6 Press **Auto Deskew**.
- 7 Press **Auto (or Off)**.
- 8 If you do not want to change additional settings, press **OK**, and then press **Black Start** or **Color Start**.

NOTE

- 1to2, Poster, Ink Save Mode, Thin Paper Copy, Book Copy, Watermark Copy, Remove Background Color, ADF High Speed Mode, 2-sided→2-sided and 2-sided→1-sided of 2-sided Copy are not available with **Auto Deskew**.
 - You cannot use this setting with Ledger, A3 or paper that is smaller than 2.52 in. × 3.58 in. (64 mm × 91 mm).
 - This setting is only available for paper that is rectangular or square.
 - You cannot use this setting with a thick document, such as a book.
 - Auto Deskew is only available if the document is skewed by less than 3 degrees.
-

Book Copy

Book Copy corrects dark borders and skew when copying from the scanner glass. Your machine can automatically correct the data.

- 1 Load your document.
- 2 Press  (Copy).
- 3 Enter the number of copies you want.
- 4 Press `Options`.
- 5 Swipe up or down, or press `▲` or `▼` to display `Advanced Settings`.
- 6 Press `Advanced Settings`.
- 7 Swipe up or down, or press `▲` or `▼` to display `Book Copy`.
- 8 Press `Book Copy`.
- 9 Read and confirm the displayed list of settings you have chosen, and then press `OK`.
- 10 If you do not want to change additional settings, press `Black Start` or `Color Start`.

NOTE

ADF High Speed Mode, Page Layout, Sort, 2-sided Copy, Auto Deskew, Ink Save Mode, Fit to Page, Thin Paper Copy, Watermark Copy and Remove Background Color are not available with Book Copy.

Watermark Copy

You can place text into your document as a Watermark. You can select one of the template watermarks.

NOTE

ADF High Speed Mode, Fit to Page, Page Layout, Auto Deskew, Thin Paper Copy, Ink Save Mode, Book Copy and Remove Background Color are not available with Watermark Copy.

Using a template

- 1 Load your document.
- 2 Press  (Copy).
- 3 Enter the number of copies you want.
- 4 Press `Options`.
- 5 Swipe up or down, or press `▲` or `▼` to display `Advanced Settings`.
- 6 Press `Advanced Settings`.
- 7 Swipe up or down, or press `▲` or `▼` to display `Watermark Copy`.
- 8 Press `Watermark Copy`.
- 9 Change the watermark settings by pressing the options displayed on the Touchscreen as needed. (For more information, see *Watermark Copy Settings* on page 52.) Press `OK`.
- 10 Press `OK` to confirm the watermark.
- 11 Press `Black Start` or `Color Start`.

Watermark Copy Settings

Option1	Option2	Option3
Watermark Copy	Text	CONFIDENTIAL* DRAFT COPY IMPORTANT URGENT
	Position	A B C D E* F G H I Pattern
	Size	Small Medium* Large
	Angle	-90° -45°* 0° 45° 90°
	Transparency	-2 -1 0* +1 +2
	Color	Black* Green Blue Purple Red Orange Yellow
	The factory settings are shown in Bold with an asterisk.	

Remove Background Color

Remove Background Color removes the background color of the document when copying. This may make the copy more readable and will also save some ink.

NOTE

This function is for use only when making color copies. The background color is automatically removed for all black & white copies.

- 1 Load your document.
- 2 Press  (Copy).
- 3 Enter the number of copies you want.
- 4 Press Options.
- 5 Swipe up or down, or press ▲ or ▼ to display Advanced Settings.
- 6 Press Advanced Settings.
- 7 Swipe up or down, or press ▲ or ▼ to display Remove Background Color.
- 8 Press Remove Background Color.
- 9 Press Low, Medium or High.
- 10 Press OK.
- 11 Press Color Start.

NOTE

ADF High Speed Mode, Fit to Page, Page Layout, Auto Deskew, Ink Save Mode, Thin Paper Copy, Book Copy and Watermark Copy are not available with Remove Background Color.

2-sided copying

You can reduce the amount of paper used for copies by copying on both sides of the paper.

We recommend you load your document in the ADF for 2-sided copying.

NOTE

- You can copy 2-sided documents up to Ledger or A3 size using the ADF.
- You can use only Letter, A4, A5, Executive, Legal, A3, or Ledger size plain paper.

- 1 Load your document.
If you want to copy a 2-sided document, load your document in the ADF.
 - 2 Press  (Copy).
 - 3 Enter the number of copies you want.
 - 4 Press **Options**.
 - 5 If you want to sort multiple copies, swipe up or down, or press ▲ or ▼ to display **Stack/Sort**.
 - 6 Press **Stack/Sort**.
 - 7 Press **Sort**.
 - 8 Swipe up or down, or press ▲ or ▼ to display **2-sided Copy**.
 - 9 Press **2-sided Copy**.
 - 10 Swipe up or down, or press ▲ or ▼ to display the 2-sided copy type you want, and press **2-sided→2-sided**, **1-sided→2-sided Long Edge Flip**, **2-sided→1-sided Long Edge Flip**, **1-sided→2-sided Short Edge Flip**, **2-sided→1-sided Short Edge Flip**, (**or Off**).
- (See *2-sided copying type* on page 54.)
- 11 Review your settings on the Touchscreen, and then press **OK**.

- 12 Press **Black Start** or **Color Start**.
If you placed the document in the ADF, the machine scans the pages and starts printing.

If you are using the scanner glass, go to step 13.

- 13 The Touchscreen shows:

Turn over the document (or Flip the book), then press [Scan]. When you finish, press [Complete].

Place the next page on the scanner glass and press **Scan**.

Press **OK**.

The machine starts printing.

- 14 If you pressed **Sort** for multiple copies, repeat step 13 for each page.
After all the pages have been scanned, press **Complete**.
The machine starts printing.

DO NOT touch the printed page until it is ejected the second time. The machine will print the first side and eject the paper and then pull the paper in to print the second side.

NOTE

- If you get a paper jam, press **Advanced** after step 9, and then press one of the jam prevention settings: **2-sided 1** or **2-sided 2**.
2-sided 1 uses a longer print time for the ink to dry.
2-sided 2 uses a longer print time and will also print in lighter colors.
- **2in1 (ID)**, **Poster**, **Book Copy** and **Fit to Page** are not available with **2-sided Copy**.
- **1to2** and **Auto Des skew** are not available with **2-sided→2-sided** and **2-sided→1-sided**.

2-sided copying type

■ **1 sided → 2 sided**

(Long edge flip)

Portrait

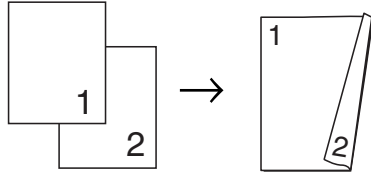

Landscape

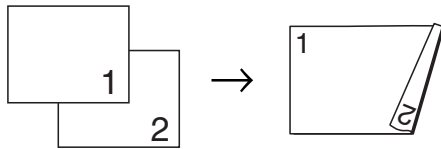

(Short edge flip)

Portrait

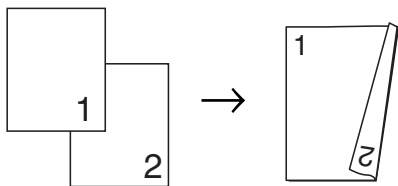

Landscape

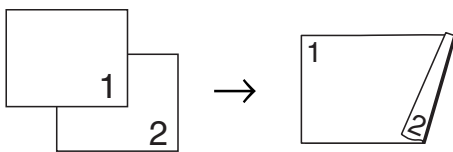

■ **2 sided → 2 sided**

Portrait

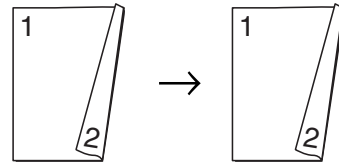

Landscape

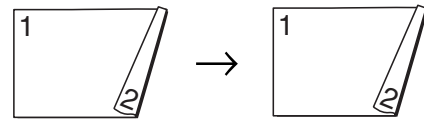

■ **2 sided → 1 sided**

(Long edge flip)

Portrait

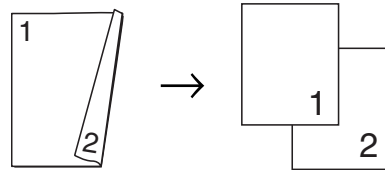

Landscape

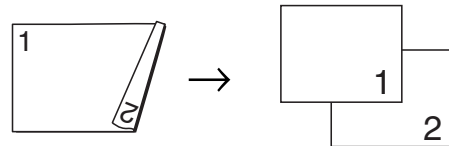

(Short edge flip)

Portrait

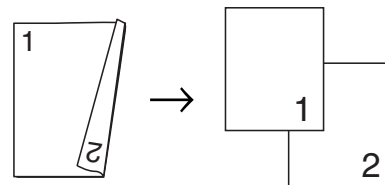

Landscape

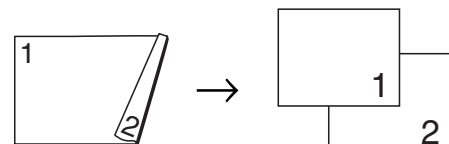

Saving copy options as a Shortcut

You can store the copy options you use frequently by saving them as a Shortcut.

- 1 Press  (Copy).
- 2 Press **Options**.
- 3 Swipe up or down, or press **▲** or **▼** to display ADF High Speed Mode, Quality, Paper Type, Paper Size, Tray Select, Enlarge/Reduce, Density, Stack/Sort, Page Layout, 2-sided Copy or Advanced Settings, and then press the setting you want to change. Then press the new option you want.

Repeat this step for each setting you want to change.

- 4 When you are finished choosing new options, press **Save as Shortcut**.
- 5 Read and confirm the displayed list of options you have chosen for the Shortcut, and then press **OK**.
- 6 Enter a name for the Shortcut using the keyboard on the Touchscreen. (For help entering letters, see Basic User's Guide: *Entering Text*.) Press **OK**.
- 7 Press **OK** to save your Shortcut.

Ledger Copy Shortcuts

Ledger Copy Shortcut

You can copy your document in Ledger or A3 size paper with a format such as Note style. Also you can make 2 in 1, enlarged and reduced copies.

■ Ledger

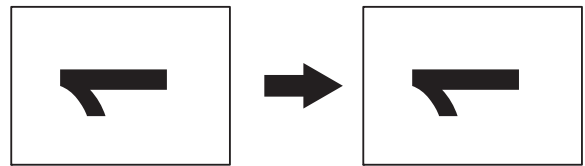

■ Ledger 2in1

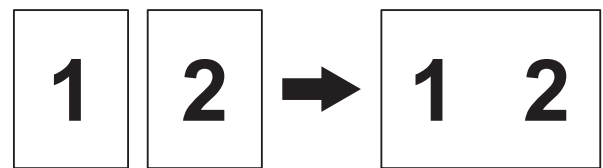

■ Letter + Note (L)

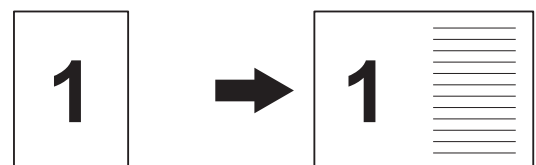

■ Letter + Note (P)

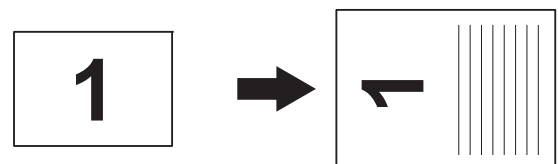

■ Letter + Grid

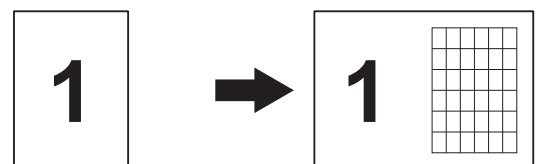

■ Letter + Blank

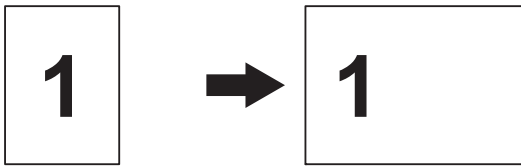

■ Letter Center

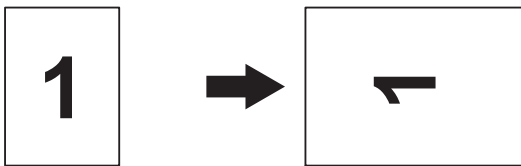

■ Letter → Ledger

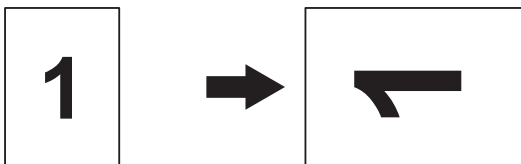

■ Ledger → Letter

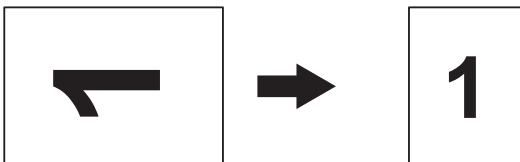

NOTE

- You can use only Ledger or A3 size plain paper, with the exception that you must use Letter or A4 size plain paper when choosing Ledger → Letter.
- If you are producing multiple color copies, Ledger 2in1, Letter + Note(L), Letter + Note(P), Letter + Grid and Letter + Blank are not available.
- (P) means Portrait and (L) means Landscape.
- You can enlarge a copy only when using Letter → Ledger. Also, you can reduce a copy only when using Ledger → Letter.

- 1 Load your document.
- 2 If the displayed screen is either Home or Shortcut, swipe left or right, or press ◀ or ▶ to display the More screen.
- 3 Press LGR Copy Shortcuts.
- 4 If information appears on the Touchscreen, read it and then press OK to confirm it. Load Ledger or A3 size paper according to the on-screen instructions.
- 5 Swipe left or right to display Ledger 2in1, Ledger, Letter → Ledger, Ledger → Letter, Letter + Note(L), Letter + Note(P), Letter + Grid, Letter + Blank or Letter Center, and then press the option you want. Press OK.
- 6 Enter the number of copies you want.
- 7 Do one of the following:
 - If you want to change more settings, go to step 8.
 - If you do not want to change more settings, go to step 12.

- 8 Press **Options**.
- 9 Press the setting you want to change.
- 10 Press your new option.

Repeat steps 9 and 10 to change other settings as needed.
- 11 Press **OK** when you are finished changing the options.
- 12 Press **Black Start** or **Color Start**.

If you are using the scanner glass when choosing Ledger 2in1, go to step 13.

- 13 After the machine has scanned the page, press **Yes** to scan the next page.
- 14 Place the next page on the scanner glass. Press **OK** to scan the page.

Repeat steps 13 and 14 for each page of the layout.
- 15 After all the pages have been scanned, press **No** to finish.

PhotoCapture Center™: Printing photos from a memory card or USB Flash drive

PhotoCapture Center™ operations

Memory cards, USB Flash drives and folder structures

Your machine is designed to be compatible with modern digital camera image files, memory cards and USB Flash drives; however, please read the bullet points to avoid errors:

- The image file extension must be .JPG (other image file extensions like .JPEG, .TIF, .GIF and so on will not be recognized).
- Direct PhotoCapture Center™ printing must be performed separately from PhotoCapture Center™ operations using the PC. (Simultaneous operation is not available.)
- The machine can read up to 999 files ¹ on a memory card or USB Flash drive.
 - ¹ The folder inside memory cards or USB Flash drives is also counted.
- The DPOF file on the memory cards must be in a valid DPOF format. (See *DPOF printing* on page 64.)

Please be aware of the following:

- When printing an index or image, the PhotoCapture Center™ will print all the valid images, even if one or more images have been corrupted. Corrupted images will not be printed.

■ (Memory card users)

Your machine is designed to read memory cards that have been formatted by a digital camera.

When a digital camera formats a memory card, it creates a special folder into which it copies image data. If you need to modify the image data stored on a memory card with your PC, we recommend that you do not modify the folder structure created by the digital camera. When saving new or modified image files to the memory card, we also recommend you use the same folder your digital camera uses. If the data is not saved to the same folder, the machine may not be able to read the file or print the image.

■ (USB Flash drive users)

This machine supports USB Flash drives that have been formatted by Windows®.

Movie printing

You can print images from movie files that are stored on a memory card or USB Flash drive.

A movie file is automatically divided into 9 parts by movie recording times and is placed in 3 lines. You can then see and print the scenes that have been divided.

NOTE

- You cannot choose a particular movie scene.
 - You can use AVI or MOV movie file formats (Motion JPEG only). However, if an AVI file size is 1 GB or more (the shooting time is about 30 minutes) or a MOV file size is 2 GB or more (the shooting time is about 60 minutes), these files cannot be printed.
 - If the data for a divided scene is corrupted, the part for that scene will be blank.
-

Print Images

Print Index (Thumbnails)

The PhotoCapture Center™ assigns numbers for images (such as No.1, No.2, No.3, and so on).



→ NO. 1
DEI.JPG 01. 01. 2009
100KB

The PhotoCapture Center™ does not recognize any other numbers or file names that your digital camera or computer has used to identify the pictures. You can print a thumbnail page. This will show all the pictures on the memory card or USB Flash drive.

NOTE

Only file names that are 20 characters or less will be printed correctly on the index sheet.

- 1 Open the media slot cover.
- 2 Put the memory card or USB Flash drive in the correct slot.
- 3 Press **Photo**.
- 4 Swipe left or right to display **Index Print**.
- 5 Press **Index Print**. Press **OK**.
- 6 Press **Print Index Sheet**.

- 7 Do one of the following:
 - Press **Print Settings** to change the paper type or the paper size you are using.
Go to step 8.
 - If you do not want to change the paper settings, press **Start**.
- 8 Press **Paper Type**.
- 9 Press **Plain Paper, Inkjet Paper, Brother BP71 or Other Glossy**.
- 10 Press **Paper Size**.
- 11 Press **Letter or A4**.
- 12 Press **OK**.
- 13 Press **Start** to print.

Printing Photos

Before you can print an individual image, you have to know the image number.

- 1 Open the media slot cover.
- 2 Put the memory card or USB Flash drive in the correct slot.
- 3 Press **Photo**.
- 4 Print the Index. (See *Print Index (Thumbnails)* on page 59.)
- 5 Swipe left or right to display **Index Print**.
- 6 Press **Index Print**.
Press **OK**.
- 7 Press
Print Photos Using Index No.
- 8 Enter the image number that you want to print from the Index page (Thumbnails). After you have chosen the image numbers, press **OK**.

NOTE

- You can enter multiple numbers at one time by using a comma or a hyphen. For example, Enter 1,3,6 to print images No.1, No.3 and No.6. Enter 1-5 to print images No.1 to No.5.
- You can enter up to 12 characters (including commas and hyphens) for the image numbers you want to print.

- 9 Enter the number of copies you want by using the dial pad on the Touchpanel.
- 10 Do one of the following:
 - Press **Print Settings** to change the print settings. (See *PhotoCapture Center™ print settings* on page 65.)
 - If you do not want to change any settings, press **Start** to print.

Enhance Photos

You can edit and add effects to your photos and view them on the Touchscreen before printing.

NOTE

The **Enhance Photos** feature is supported by technology from Reallusion, Inc.  **REALLUSION**

- 1 Open the media slot cover.
- 2 Put the memory card or USB Flash drive in the correct slot.
- 3 Press **Photo**.
- 4 Swipe left or right to display **Enhance Photos**.
- 5 Press **Enhance Photos**.
Press **OK**.



NOTE







- Eight thumbnails are displayed at a time with the current page number and total number of pages listed above the thumbnails.
- Swipe left or right, or press ◀ or ▶ repeatedly to scroll through all photos. Hold down ◀ or ▶ to fast-forward and fast-rewind through the thumbnail pages.

- 6 Press a photo from the thumbnails.
- 7 Press Enhance, Crop or Enhance and Crop.
- 8 Do one of the following:
 - If you chose Enhance or Enhance and Crop, go to step 9.
 - If you chose Crop, go to step 10.
- 9 Press the effect you wish to add. Press OK. Do one of the following:
 - If you chose Enhance in step 8, go to step 11.
 - If you chose Enhance and Crop in step 8, go to step 10.

NOTE

- There are ten ways you can add effects to your photo.

	(Auto Correct) The machine decides the suitable effect for your photo.
	(Enhance Skin) Best used for adjusting portrait photographs. It adjusts human skin color. Press ◀ or ▶ to adjust the level of contrast.
	(Enhance Scenery) Best used for adjusting landscape photographs. It highlights green and blue areas in your photo. Press ◀ or ▶ to adjust the level of contrast.

	(Remove Red-Eye) The machine will attempt to remove red-eye from your photo. If red-eye detection fails, you can press Try Again to re-detect.
	(Night Scene) Night Scene is best used for adjusting night view photographs to make them more vivid. Press ◀ or ▶ to adjust the level of contrast.
	(Fill Light) Fill Light is best used for adjusting photographs against the light. Press ◀ or ▶ to adjust the level of contrast.
	(Whiteboard) Whiteboard is best used for adjusting photographs. It detects letters on a whiteboard in your photo and makes them more legible.
	(Monochrome) You can convert your photo to black & white.
	(Sepia) You can convert the color of your photo to sepia.
	(Auto Correct & Remove Red-Eye) The machine decides the suitable effects for your photo. Also, it will attempt to remove red-eye from your photo.

- There are some cases when red-eye may not be removed.
 - When the face is too small in the image.
 - When the face is turning too far up, down, left or right.
- Press Cancel to return to the list of effects.
- If your photo is very small or has irregular proportions, you may not be able to crop or enhance it. The Touchscreen will display Image Too Small or Image Too Long.

- 10** Adjust the red frame around your photo. The part inside of the red frame will be printed.

- Press **+** or **-** to enlarge or reduce the frame size.
- Press **▲**, **▼**, **◀** or **▶** to move the position of the frame.
- Press  to rotate the frame.

Press **OK** when you have finished adjusting the frame setting.
Press **OK** to confirm.

NOTE

If your photo is very small or has irregular proportions, you may not be able to crop or enhance it. The Touchscreen will display *Image Too Small* or *Image Too Long*.

- 11** Enter the number of copies you want, either by pressing **+** or **-** or using the dial pad on the Touchpanel. Press **OK**.
- 12** Do one of the following.
- Press **Print Settings** to change the print settings. (See *PhotoCapture Center™ print settings* on page 65.)
 - If you do not want to change any settings, press **Start** to print.

ID photo print

You can select a photo stored in a memory card or USB Flash drive and print ID photos for your resume, passport and so on. You can print four ID photos on one sheet of paper.

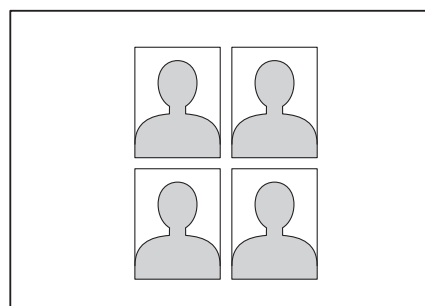

NOTE

Just one photo will be printed when you choose **2x2inch** or **50x70mm (2x2.75inch)** in **ID Photo Size**, and **4"x6"** in **Paper Size**.

- 1** Open the media slot cover.
- 2** Put the memory card or USB Flash drive in the correct slot.
- 3** Press **Photo**.
- 4** Swipe left or right to display **ID Photo Print**.
- 5** Press **ID Photo Print**. Press **OK**.
- 6** Swipe left or right, or press **◀** or **▶** to display each photo. When the photo you want is displayed, press it.

- 7 Swipe up or down, or press ▲ or ▼ to display 2x2inch, 25x36mm, 35x45mm, 36x51mm, 45x45mm, 45x55mm, 35x48mm or 50x70mm (2x2.75inch), and then press the option you want to set as the photo size.

NOTE

The machine automatically crops the photo according to the size you choose. You cannot trim the photo further.

- 8 Confirm the image displayed on the Touchscreen. Rotate the image if necessary by pressing .
- 9 Press OK.
- 10 Do one of the following:
 - Press **Print Settings** to change the print settings. Go to step 11.
 - If you do not want to change any settings, press **Start** to print.
- 11 Do one of the following:
 - To change the print quality, press **Print Quality**. Press **Normal** or **Photo**.
 - To change the paper type, press **Paper Type**. Press **Plain Paper**, **Inkjet Paper**, **Brother BP71** or **Other Glossy** that you want to set.
 - To change the paper size, press **Paper Size**. Press **4"x6"**, **5"x7"**, **Letter** or **A4** that you want to set.
 - To add enhancement effects, press **Photo Enhance**. Press **Auto Correct**, **Remove Red-Eye**, **Auto Correct & Remove Red-Eye** or **Off** that you want to set.

- 12 When you are finished changing the settings press **OK**.
- 13 Press **Start**.

Slide Show

You can view all your photos on the Touchscreen using **Slide Show**. You can also choose a photo during the operation.

- 1 Open the media slot cover.
- 2 Put the memory card or USB Flash drive in the correct slot.
- 3 Press **Photo**.
- 4 Swipe left or right to display **Slide Show**.
- 5 Press **Slide Show**. Press **OK**.
- 6 Do one of the following:
 - If you want to change the length of time the Touchscreen shows each photo, press **Show Each Photo for**. Swipe up or down, or press ▲ or ▼ to display **3Secs**, **10Secs**, **30Secs**, **1Min** or **5Mins**, and then press the option you want to set.
 - If you want to change the effect, press **Effect**. Press **Slide In**, **Fade In**, **Zoom In** or **Off**.
 - If you do not want to change the settings, press **Start**.
- 7 Press  to finish **Slide Show**.

Printing a photo during a Slide Show

- 1 To print an image during a slide show, press the image when it appears on the Touchscreen.
- 2 Enter the number of copies you want using the dial pad on the Touchpanel.
- 3 Do one of the following:
 - Press `Print Settings` to change the print settings. (See *PhotoCapture Center™ print settings* on page 65.)
 - If you do not want to change any settings, press `Start` to print.

DPOF printing

DPOF stands for Digital Print Order Format.

Major digital camera manufacturers (Canon Inc., Eastman Kodak Company, FUJIFILM Corporation, Panasonic Corporation and Sony Corporation) created this standard to make it easier to print images from a digital camera.

If your digital camera supports DPOF printing, you will be able to use it to choose the images and number of copies you want to print.

When a memory card (Memory Stick Duo™, Memory Stick PRO Duo™, SD Memory Card, SDHC Memory Card, SDXC Memory Card, MultiMedia Card or MultiMedia Card plus) containing DPOF information is put into your machine, you can print the chosen image easily.

- 1 Open the media slot cover.
- 2 Put the memory card or USB Flash drive in the correct slot.
- 3 Press `DPOF`.

- 4 Do one of the following:

- Press `Print Settings` to change the print settings. (See *PhotoCapture Center™ print settings* on page 65.)
- If you do not want to change any settings, press `Start` to print.

NOTE

An Invalid DPOF File error can occur if the print order that was created on the camera has been corrupted. Delete and recreate the print order using your camera to correct this problem. For instructions on how to delete or recreate the print order, refer to your camera manufacturer's support website or accompanying documentation.

PhotoCapture Center™ print settings

You can change the print settings for the next print job.

These settings are temporary, and the machine returns to its default settings 1 minute after printing.

NOTE

You can save the print settings you use most often by setting them as the default settings. (See *Setting your changes as the new default* on page 71.)



Print Quality

- 1 Open the media slot cover.
- 2 Put the memory card or USB Flash drive in the correct slot.
- 3 Press **Photo**.
- 4 Swipe left or right to display **View Photos**.
- 5 Press **View Photos**. Press **OK**.
- 6 Swipe left or right, or press ◀ or ▶ to display each photo. When the photo you want is displayed, press it, and then press **OK**.
- 7 Press **OK**.
- 8 Press **Print Settings**.

- 9 Swipe up or down, or press ▲ or ▼ to display **Print Quality**.
- 10 Press **Print Quality**.
- 11 Press **Normal** or **Photo**.
- 12 If you do not want to change additional settings, press ↩ or **OK**. Press **Start** to print.

NOTE

If you choose **Inkjet Paper** in **Paper Type**, you can only choose **Photo**.

Paper options

Paper Type

- 1 Open the media slot cover.
- 2 Put the memory card or USB Flash drive in the correct slot.
- 3 Press **Photo**.
- 4 Swipe left or right to display **View Photos**.
- 5 Press **View Photos**. Press **OK**.
- 6 Swipe left or right, or press ◀ or ▶ to display each photo. When the photo you want is displayed, press it, and then press **OK**.
- 7 Press **OK**.
- 8 Press **Print Settings**.
- 9 Swipe up or down, or press ▲ or ▼ to display **Paper Type**.
- 10 Press **Paper Type**.
- 11 Press **Plain Paper**, **Inkjet Paper**, **Brother BP71** or **Other Glossy**.







- 12 If you do not want to change additional settings, press  or OK. Press **Start** to print.

Paper Size and Print Size

- 1 Open the media slot cover.
- 2 Put the memory card or USB Flash drive in the correct slot.
- 3 Press **Photo**.
- 4 Swipe left or right to display **View Photos**.
- 5 Press **View Photos**. Press **OK**.
- 6 Swipe left or right, or press **◀** or **▶** to display each photo. When the photo you want is displayed, press it, and then press **OK**.
- 7 Press **OK**.
- 8 Press **Print Settings**.
- 9 Swipe up or down, or press **▲** or **▼** to display **Paper Size**.
- 10 Press **Paper Size**.
- 11 Swipe up or down, or press **▲** or **▼** to display **4"x6"**, **5"x7"**, **Letter**, **Ledger**, **A4** or **A3**. Press the option you want to set. Do one of the following:
 - If you chose **Letter** or **A4**, go to step 12.
 - If you chose **4"x6"**, **5"x7"**, **Ledger** or **A3**, go to step 13.

- 12 Press **Print Size**. Swipe up or down, or press **▲** or **▼** to display the options in the following table, and then press the option you want to set.

Example: Printed position for Letter size paper

1 3"x4"	2 3.5"x5"	3 4"x6"
		
4 5"x7"	5 6"x8"	6 Max. Size
		

- 13 If you do not want to change additional settings, press  or OK. Press **Start** to print.

Auto Correct

Auto Correct is available for most photos. The machine decides the suitable effect for your photo.

- 1 Open the media slot cover.
- 2 Put the memory card or USB Flash drive in the correct slot.
- 3 Press **Photo**.
- 4 Swipe left or right to display **View Photos**.
- 5 Press **View Photos**. Press **OK**.
- 6 Swipe left or right, or press ◀ or ▶ to display each photo. When the photo you want is displayed, press it, and then press **OK**.
- 7 Press **OK**.
- 8 Press **Print Settings**.
- 9 Swipe up or down, or press ▲ or ▼ to display **Auto Correct**.
- 10 Press **Auto Correct**.
- 11 Press **On (or Off)**.
- 12 If you do not want to change additional settings, press  or **OK**. Press **Start** to print.

Adjusting Brightness, Contrast and Color

Brightness

- 1 Open the media slot cover.
- 2 Put the memory card or USB Flash drive in the correct slot.
- 3 Press **Photo**.
- 4 Swipe left or right to display **View Photos**.
- 5 Press **View Photos**. Press **OK**.
- 6 Swipe left or right, or press ◀ or ▶ to display each photo. When the photo you want is displayed, press it, and then press **OK**.
- 7 Press **OK**.
- 8 Press **Print Settings**.
- 9 Swipe up or down, or press ▲ or ▼ to display **Brightness**.
- 10 Press **Brightness**.
- 11 Adjust the level of brightness by pressing it on the Touchscreen.
- 12 If you do not want to change additional settings, press  or **OK**. Press **Start** to print.

Contrast



You can choose the contrast setting. Increasing the contrast will make an image look sharper and more vivid.

- 1 Open the media slot cover.
- 2 Put the memory card or USB Flash drive in the correct slot.
- 3 Press `Photo`.
- 4 Swipe left or right to display `View Photos`.
- 5 Press `View Photos`. Press `OK`.
- 6 Swipe left or right, or press ◀ or ▶ to display each photo. When the photo you want is displayed, press it, and then press `OK`.
- 7 Press `OK`.
- 8 Press `Print Settings`.
- 9 Swipe up or down, or press ▲ or ▼ to display `Contrast`.
- 10 Press `Contrast`.
- 11 Adjust the level of contrast by pressing it on the Touchscreen.
- 12 If you do not want to change additional settings, press  or `OK`. Press `Start` to print.

Color Enhancement

You can turn on the color enhancement feature to print more vivid images. Print time will be slower, and depending on the image, this feature may use more ink.

- 1 Open the media slot cover.
- 2 Put the memory card or USB Flash drive in the correct slot.
- 3 Press `Photo`.
- 4 Swipe left or right to display `View Photos`.
- 5 Press `View Photos`. Press `OK`.
- 6 Swipe left or right, or press ◀ or ▶ to display each photo. When the photo you want is displayed, press it, and then press `OK`.
- 7 Press `OK`.
- 8 Press `Print Settings`.
- 9 Swipe up or down, or press ▲ or ▼ to display `Color Enhance`.
- 10 Press `Color Enhance`.
- 11 Do one of the following:
 - If you want to customize the `White Balance`, `Sharpness` or `Color Density`, press `Color Enhance`, and then press `On`.
Go to step 12.
 - If you do not want to customize, press `Color Enhance`, and then press `Off`.
Press .
Go to step 15.
- 12 Press `White Balance`, `Sharpness` or `Color Density`.

- 13 Press ◀ or ▶ to adjust the degree of the setting.
Press OK.
- 14 Do one of the following:
- If you want to customize another color enhancement, repeat steps 12 and 13.
Press .
 - If you want to change other settings, press  to display the print setting menu and press the setting you want to change. (See *PhotoCapture Center™ print settings* on page 65.)
- 15 If you do not want to change additional settings, press  or OK.
Press Start to print.

NOTE

• White Balance

This setting adjusts the hue of the white areas of an image. Lighting, camera settings and other influences will affect the appearance of white. The white areas of a picture may be slightly pink, yellow or some other color. By using this setting, you can correct that effect and bring the white areas back to pure white.

• Sharpness

This setting enhances the detail of an image, similar to adjusting the fine focus on a camera. If the image is not in true focus and you cannot see the fine details of the picture, then adjust the sharpness.

• Color Density

This setting adjusts the total amount of color in the image. You can increase or decrease the amount of color in an image to improve a washed-out or weak picture.

Cropping

If your photo is too long or too wide to fit the available space on your chosen layout, part of the image will be cropped.

The factory setting is On. If you want to print the whole image, change this setting to Off. If you set Cropping to Off, also set Borderless to Off. (See *Borderless printing* on page 70.)

- 1 Open the media slot cover.
- 2 Put the memory card or USB Flash drive in the correct slot.
- 3 Press Photo.
- 4 Swipe left or right to display View Photos.
- 5 Press View Photos.
Press OK.
- 6 Swipe left or right, or press ◀ or ▶ to display each photo. When the photo you want is displayed, press it, and then press OK.
- 7 Press OK.
- 8 Press Print Settings.
- 9 Swipe up or down, or press ▲ or ▼ to display Cropping.
- 10 Press Cropping.
- 11 Press Off (or On).
- 12 If you do not want to change additional settings, press  or OK.
Press Start to print.

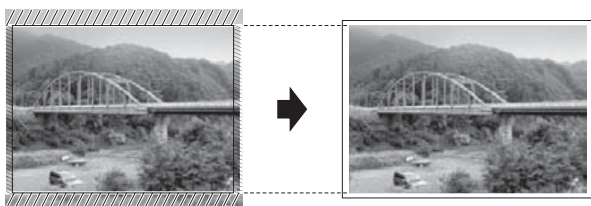
Cropping: On**Cropping: Off**

Borderless printing

This feature expands the printable area to the edges of the paper. Printing time will be slightly slower.

- 1 Open the media slot cover.
- 2 Put the memory card or USB Flash drive in the correct slot.
- 3 Press **Photo**.
- 4 Swipe left or right to display **View Photos**.
- 5 Press **View Photos**. Press **OK**.
- 6 Swipe left or right, or press ◀ or ▶ to display each photo. When the photo you want is displayed, press it, and then press **OK**.
- 7 Press **OK**.
- 8 Press **Print Settings**.
- 9 Swipe up or down, or press ▲ or ▼ to display **Borderless**.
- 10 Press **Borderless**.
- 11 Press **Off (or On)**.

- 12 If you do not want to change additional settings, press ⏪ or **OK**. Press **Start** to print.

Print Date

You can print the date if it is already in your photo's data. The date will be printed on the lower-right corner. If the data doesn't have the date information, you cannot use this function.

- 1 Open the media slot cover.
- 2 Put the memory card or USB Flash drive in the correct slot.
- 3 Press **Photo**.
- 4 Swipe left or right to display **View Photos**.
- 5 Press **View Photos**. Press **OK**.
- 6 Swipe left or right, or press ◀ or ▶ to display each photo. When the photo you want is displayed, press it, and then press **OK**.
- 7 Press **OK**.
- 8 Press **Print Settings**.
- 9 Swipe up or down, or press ▲ or ▼ to display **Print Date**.
- 10 Press **Print Date**.
- 11 Press **On (or Off)**.
- 12 If you do not want to change additional settings, press ⏪ or **OK**. Press **Start** to print.

NOTE

The DPOF setting on your camera must be turned off to use the **Print Date** feature.

Setting your changes as the new default

You can save the print settings you use most often—such as `Print Quality`, `Paper Type`, `Paper Size`, `Print Size`, `Auto Correct`, `Brightness`, `Contrast`, `Color Enhance`, `Cropping`, `Borderless` and `Print Date`—by setting them as the default settings. These settings will stay until you change them again.

- 1 Open the media slot cover.
- 2 Put the memory card or USB Flash drive in the correct slot.
- 3 Press `Photo`.
- 4 Swipe left or right to display `View Photos`.
- 5 Press `View Photos`. Press `OK`.
- 6 Swipe left or right, or press ◀ or ▶ to display each photo. When the photo you want is displayed, press it, and then press `OK`.
- 7 Press `OK`.
- 8 Press `Print Settings`.
- 9 Press your new setting. Repeat this step for each setting you want to change.
- 10 After changing the last setting, swipe up or down, or press ▲ or ▼ to display `Set New Default`.
- 11 Press `Set New Default`.
- 12 The Touchscreen asks you to confirm the change to the new default settings. Press `Yes` to confirm.
- 13 Press .

Restoring all settings to the factory settings

You can restore the PhotoCapture settings that you have changed—such as `Print Quality`, `Paper Type`, `Paper Size`, `Print Size`, `Auto Correct`, `Brightness`, `Contrast`, `Color Enhance`, `Cropping`, `Borderless` and `Print Date`—to the factory settings.

- 1 Open the media slot cover.
- 2 Put the memory card or USB Flash drive in the correct slot.
- 3 Press `Photo`.
- 4 Swipe left or right to display `View Photos`.
- 5 Press `View Photos`. Press `OK`.
- 6 Swipe left or right, or press ◀ or ▶ to display each photo. When the photo you want is displayed, press it, and then press `OK`.
- 7 Press `OK`.
- 8 Press `Print Settings`.
- 9 Swipe up or down, or press ▲ or ▼ to display `Factory Reset`.
- 10 Press `Factory Reset`.
- 11 The Touchscreen asks you to confirm to change back to the factory settings. Press `Yes` to confirm.
- 12 Press .

Scan to a memory card or USB Flash drive

Auto Crop

You can scan multiple documents placed on the scanner glass. An individual document can be previewed on the Touchscreen before you save it. When you choose *Auto Crop*, the machine will scan each document and create separate files. For example, if you place four documents on the scanner glass, the machine will scan and create four separate files. If you want to create a four-page file, choose *PDF* or *TIFF* for *File Type*.

(If you choose *JPEG*, the four documents are created as four separate files.)

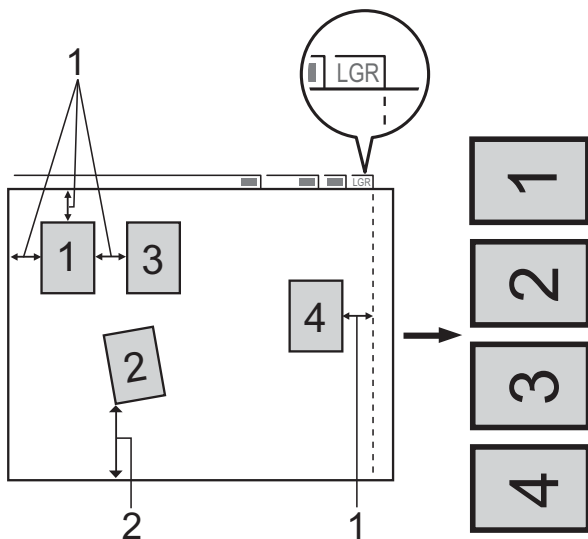

1 0.4 in. (10 mm) or greater (top, left, right)

2 0.8 in. (20 mm) or greater (bottom)

NOTE

Auto Crop is supported by technology from Reallusion, Inc.



- 1** Open the media slot cover.
- 2** Put the memory card or USB Flash drive in the correct slot.

- 3** Press *Scan to Media*.
- 4** Load your document.
- 5** Press *Options*.
- 6** Swipe up or down, or press ▲ or ▼ to display *Auto Crop*.
- 7** Press *Auto Crop*.
- 8** Press *On*.
- 9** Press *OK*.
- 10** If you do not want to change additional settings, press *Start* to start scanning.
- 11** The number of the scanned documents appears on the Touchscreen. Press *OK* to confirm.
- 12** Press ◀ or ▶ to preview the data for each document.
- 13** Press *Save All* to save the data.

NOTE

- **Auto Crop** is available for paper with 90-degree angles at all four corners. If one of the angles is not square, **Auto Crop** cannot detect the document.
- If your document is too long or wide, this setting does not work properly. The document has to meet the following specification: up to 10.6 × 16.54 in. (270 × 420 mm).

If the ratio between the height and width of the document is more than 1 to 8, this setting does not work correctly.
- You must place the documents away from the edges of the scanner glass as shown in the illustration.
- You must place the documents at least 0.4 in. (10 mm) apart from each other.
- **Auto Crop** adjusts the skew of the document on the scanner glass, but if your document is skewed more than 10 degrees, this setting will not work.
- The ADF must be empty to use **Auto Crop**.
- The **Auto Crop** feature is available for up to a maximum of 32 documents, depending on the documents' sizes.
- ADF High Speed Mode, 2-sided Scan and Skip Blank Page are not available with **Auto Crop**.

IMPORTANT

DO NOT take out the memory card or USB Flash drive while the machine is reading or writing to the memory card or USB Flash drive to avoid damaging the card, USB Flash drive, or the data stored on them.

How to set a new default

You can save the **Scan to Media** settings (ADF High Speed Mode, Scan Type, Resolution, File Type, Scan Size, Scan Long Paper, Auto Crop, Skip Blank Page and Remove Background Color) you use most often by setting them as the default settings. These settings will remain until you change them again.

- 1 Open the media slot cover.
- 2 Put the memory card or USB Flash drive in the correct slot.
- 3 Press **Scan to Media**.
- 4 Press **Options**.
- 5 Swipe up or down, or press ▲ or ▼ to display ADF High Speed Mode, Scan Type, Resolution, File Type, Scan Size, Scan Long Paper, Auto Crop, Skip Blank Page or Remove Background Color, and then press the setting you want to change. Then press the option you want to set.

Repeat this step for each setting you want to change.

- 6 After you are finished choosing your preferred settings, swipe up or down, or press ▲ or ▼ to display **Set New Default**.
- 7 Press **Set New Default**.
- 8 The Touchscreen asks you to confirm the change to the new default settings. Press **Yes** to confirm.
- 9 Press .

How to reset to the factory settings

You can restore all the Scan to Media settings that you have changed—such as ADF High Speed Mode, Scan Type, Resolution, File Type, Scan Size, Scan Long Paper, Auto Crop, Skip Blank Page, and Remove Background Color—to the factory settings.

- 1 Open the media slot cover.
- 2 Put the memory card or USB Flash drive in the correct slot.
- 3 Press Scan to Media.
- 4 Press Options.
- 5 Swipe up or down, or press ▲ or ▼ to display Factory Reset.
- 6 Press Factory Reset.
- 7 The Touchscreen asks you to confirm to change back to the factory settings. Press Yes to confirm.
- 8 Press .

Saving scan options as a Shortcut

You can store the scan options you use frequently by saving them as a Shortcut. This section introduces how to add a Shortcut for Scan to Media.

- 1 Open the media slot cover.
- 2 Put the memory card or USB Flash drive in the correct slot.
- 3 Press Scan to Media.
- 4 Press Options.
- 5 Swipe up or down, or press ▲ or ▼ to display ADF High Speed Mode, 2-sided Scan, Scan Type, Resolution, File Type, Scan Size, Scan Long Paper, File Name, Auto Crop, Skip Blank Page or Remove Background Color, and then press the setting you want to change. Then press the option you want to set.

Repeat this step for each setting you want to change.

- 6 When you are finished choosing new options, press OK.
- 7 Press Save as Shortcut.
- 8 Confirm the displayed list of settings you have chosen for the Shortcut, and then press OK.
- 9 Enter a name for the Shortcut using the keyboard on the Touchscreen. (To help you enter letters, see Basic User's Guide: *Entering Text*.) Press OK.
- 10 Press OK to save your Shortcut.

Printing photos directly from a PictBridge camera



Your Brother machine supports the PictBridge standard, allowing you to connect to and print photos directly from any PictBridge compatible digital camera.

If your camera is using the USB Mass Storage standard, you can also print photos from a digital camera without PictBridge. (See *Printing photos directly from a digital camera (without PictBridge)* on page 77.)

PictBridge requirements

To avoid errors, remember the following points:

- The machine and the digital camera must be connected using a suitable USB cable.
- The image file extension must be .JPG (other image file extensions like .JPEG, .TIF, .GIF and so on will not be recognized).
- PhotoCapture Center™ operations are not available when using the PictBridge feature.

Setting your digital camera

Make sure your camera is in PictBridge mode. The following PictBridge settings may be available from the LCD of your PictBridge compatible camera.

Depending on your camera, some of these settings may not be available.

Camera Menu Selections	Options
Paper Size	Ledger, Letter, A3, A4, 4" × 6" (10 × 15 cm), Printer Settings (Default setting) ²
Paper Type	Plain Paper, Glossy Paper, Inkjet Paper, Printer Settings (Default setting) ²
Layout	Borderless: On, Borderless: Off, Printer Settings (Default setting) ²
DPOF Setting ¹	-
Print Quality	Normal, Fine, Printer Settings (Default setting) ²
Color Enhancement	On, Off, Printer Settings (Default setting) ²
Print Date	On, Off, Printer Settings (Default setting) ²

¹ See *DPOF printing* on page 77 for more details.

² If your camera is set to use the Printer Settings (Default setting), the machine will print your photo using the following settings.

Settings	Options
Paper Size	4" × 6" (10 × 15 cm)
Paper Type	Glossy Paper
Layout	Borderless: On
Print Quality	Fine
Color Enhancement	Off
Print Date	Off

- When your camera does not have any menu selections, these settings are also used.
- The name and availability of each setting depends on your camera's specifications.

Please refer to the documentation supplied with your camera for more detailed information on changing PictBridge settings.

Printing Images

NOTE

Remove any memory card or USB Flash drive from the machine before connecting a digital camera.

- 1 Open the media slot cover.
- 2 Make sure that your camera is turned off. Connect your camera to the USB direct interface (1) on the machine using the USB cable.

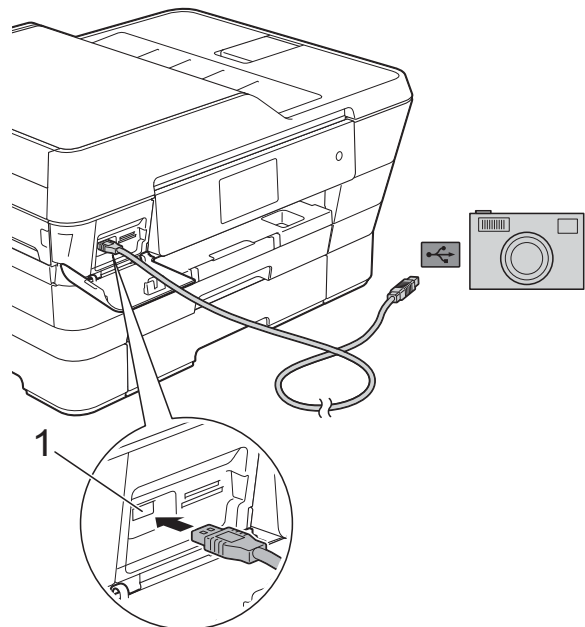

1 USB direct interface

- 3 Turn on the camera. When the machine has recognized the camera, the Touchscreen shows Camera is connected.

- 4** Choose the photo you want to print following the instructions from your camera.
When the machine starts printing a photo, the Touchscreen will show *Printing*.

IMPORTANT

To prevent damage to your machine, do not connect any device other than a digital camera or USB Flash drive to the USB direct interface.

DPOF printing

DPOF stands for Digital Print Order Format.

Major digital camera manufacturers (Canon Inc., Eastman Kodak Company, FUJIFILM Corporation, Panasonic Corporation and Sony Corporation) created this standard to make it easier to print images from a digital camera.

If your digital camera supports DPOF printing, you can choose the images and number of copies you want to print from the camera's display.

NOTE

An Invalid DPOF File error can occur if the print order that was created on the camera has been corrupted. Delete and recreate the print order using your camera to correct this problem. For instructions on how to delete or recreate the print order, refer to your camera manufacturer's support website or accompanying documentation.

Printing photos directly from a digital camera (without PictBridge)

If your camera is using the USB Mass Storage standard, you can connect your camera in storage mode. This enables you to print photos from your camera.

(If you would like to print photos in PictBridge mode, see *Printing photos directly from a PictBridge camera* on page 75.)

NOTE

The name, availability and operation differ among digital cameras. Please refer to the documentation supplied with your camera for detailed information, such as how to switch from PictBridge mode to USB mass storage mode.

Printing Images

NOTE

Remove any memory card or USB Flash drive from the machine before connecting a digital camera.

- 1 Open the media slot cover.
- 2 Make sure that your camera is turned off. Connect your camera to the USB direct interface (1) on the machine using the USB cable.

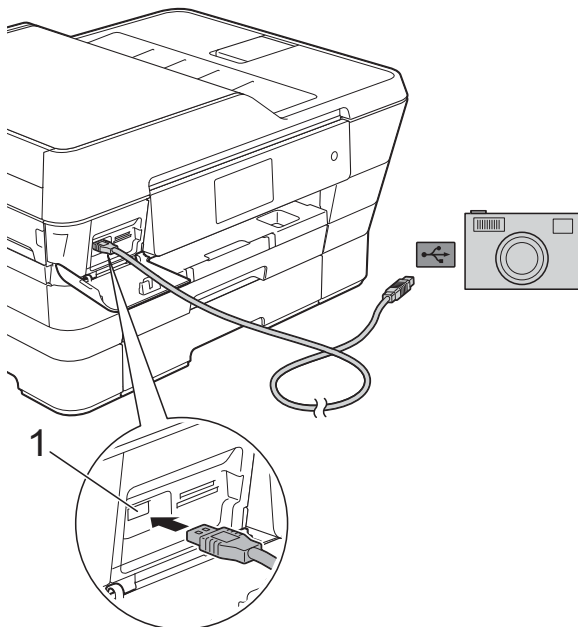

1 USB direct interface

- 3 Turn on the camera.
- 4 Follow the steps in *Print Images* on page 59.

IMPORTANT

To prevent damage to your machine, do not connect any device other than a digital camera or USB Flash drive to the USB direct interface.

A

Routine maintenance

Cleaning and checking the machine

Cleaning the outside of the machine

Clean the Touchscreen as follows:

IMPORTANT

- Press and hold down  to turn the machine off. The Touchscreen will show *Shutting Down* for a few seconds before the power goes off.
- DO NOT use any type of liquid cleaners (including ethanol).

- 1 Clean the Touchscreen with a *dry*, soft lint-free cloth.

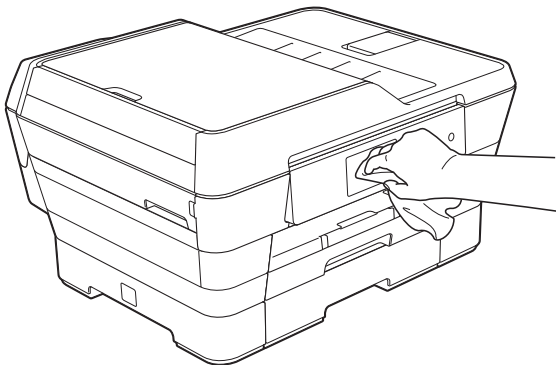

Clean the outside of the machine as follows:

IMPORTANT

- Use neutral detergents. Cleaning with volatile liquids, such as thinner or benzine, will damage the outside surface of the machine.
- DO NOT use cleaning materials that contain ammonia.
- DO NOT use isopropyl alcohol to remove dirt from the control panel. It may crack the panel.

- 1 Pull the paper tray #1 (1) and then tray #2 (2) completely out of the machine.

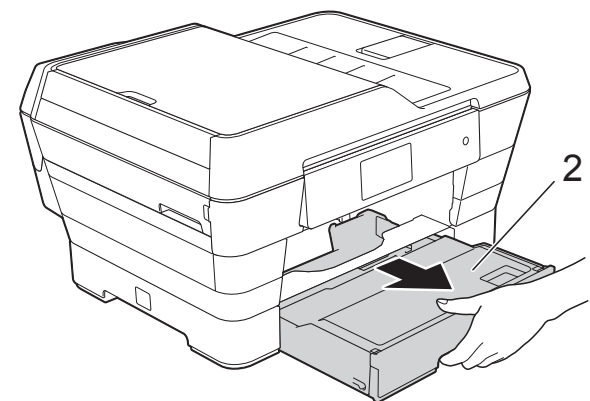
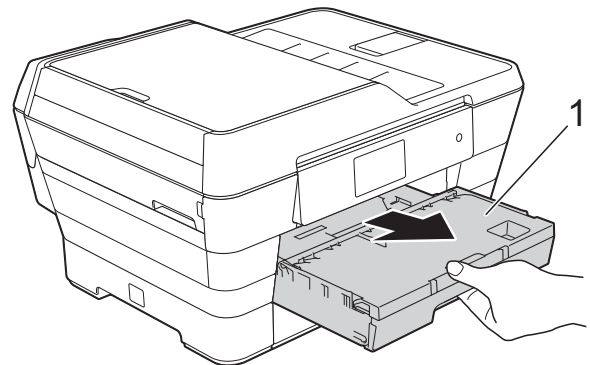

- 2 Wipe the outside of the machine with a *dry, soft, lint-free cloth* to remove dust.

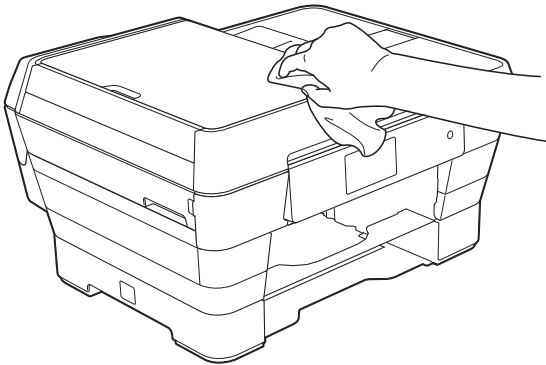

- 3 Lift the output paper tray cover and remove anything that is stuck inside the paper tray.
- 4 Wipe the inside and outside of the paper tray with a *dry, soft, lint-free cloth* to remove dust.

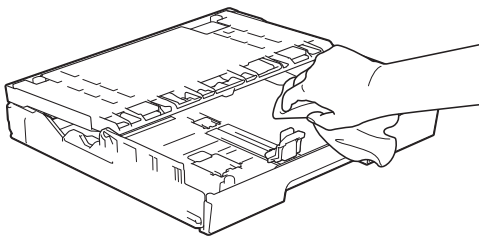

- 5 Close the output paper tray cover and put the paper tray firmly back in the machine.

Cleaning the machine's printer platen

WARNING



Be sure to unplug the machine from the AC power outlet before cleaning the printer platen to avoid an electrical shock.

- 1 Using both hands, use the finger holds on each side of the machine to lift the scanner cover into the open position.
- 2 Clean the machine's printer platen (1) and the area around it, wiping off any scattered ink with a *dry, soft, lint-free cloth*.

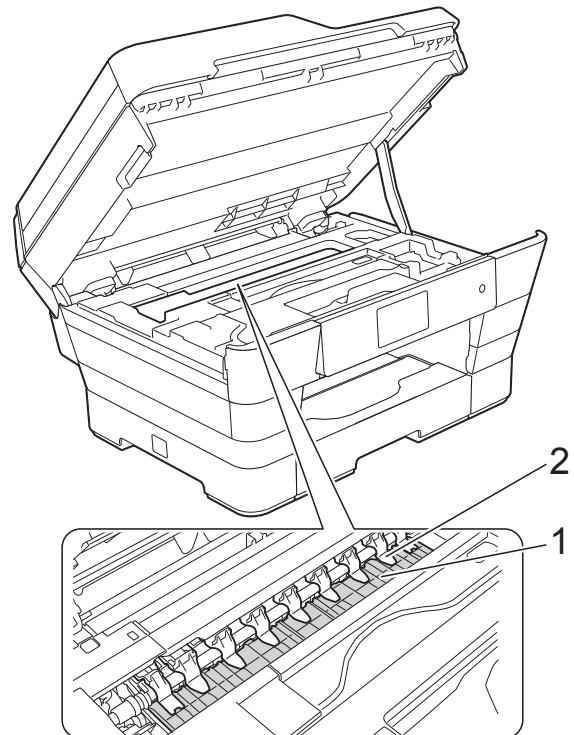

IMPORTANT

DO NOT bend or apply too much pressure on the nine tabs (2). They could be damaged.

- 3 Gently close the scanner cover using the finger holds on each side.

⚠ CAUTION

Be careful not to pinch your fingers when you close the scanner cover.

Always use the finger holds provided on each side of the scanner cover when opening and closing it.

- 4 Re-connect the power cord.

Cleaning the paper feed rollers

If the paper feed rollers are stained with ink, it may cause paper feed problems.

- 1 Unplug the machine from the AC power outlet. Pull the paper tray (1) completely out of the machine.

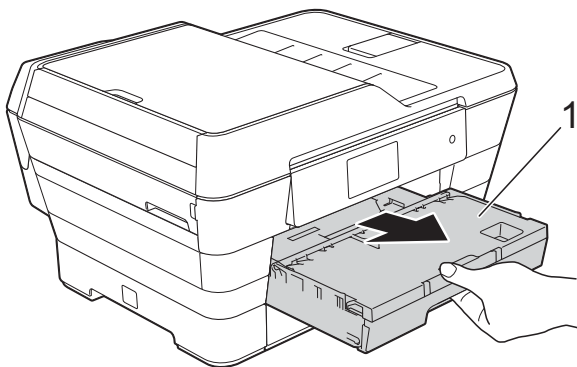

NOTE

If the paper support flap is open, close it, and then close the paper support.

- 2 Clean the front side of the Paper Feed Rollers (1) with a soft lint-free cloth moistened with water, using a side-to-side motion.

After cleaning, wipe the rollers with a *dry*, soft, lint-free cloth to remove all moisture.

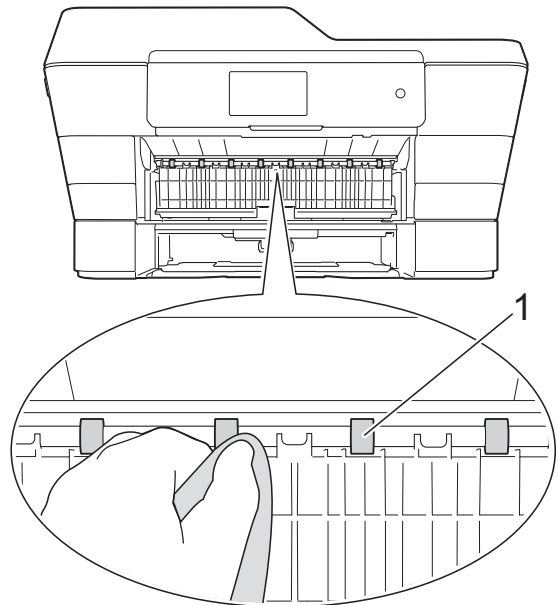

- 3 Lift the green Jam Clear Flap (2), and then clean the back side of the Paper Feed Rollers (1) with a soft lint-free cloth moistened with water.

After cleaning, wipe the rollers with a *dry*, soft, lint-free cloth to remove all moisture.

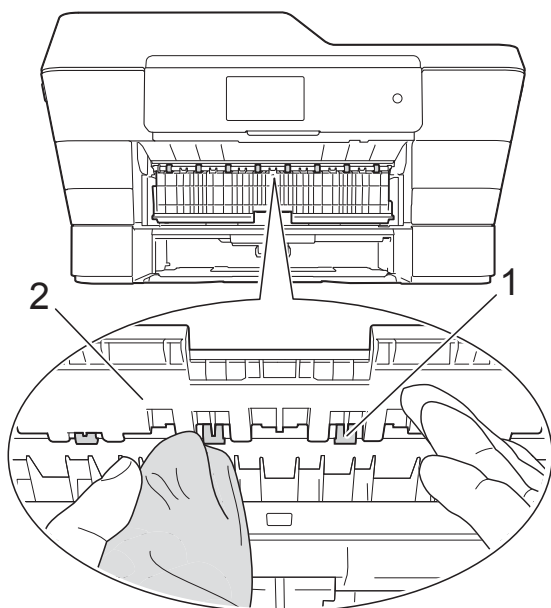

- 4 Put the paper tray firmly back in the machine.
- 5 Re-connect the power cord.

NOTE

Do not use the machine again until the rollers are dry. Using the machine before the rollers are dry may cause paper feed problems.

Cleaning the paper pick-up rollers

- 1 Unplug the machine from the AC power outlet.
- 2 Pull the paper tray completely out of the machine.

NOTE

If the machine has been feeding multiple pages when there are only a few sheets of paper left in the tray, clean the Base Pad (1) with a soft lint-free cloth moistened with water.

After cleaning, wipe the pad with a *dry*, soft, lint-free cloth to remove all moisture.

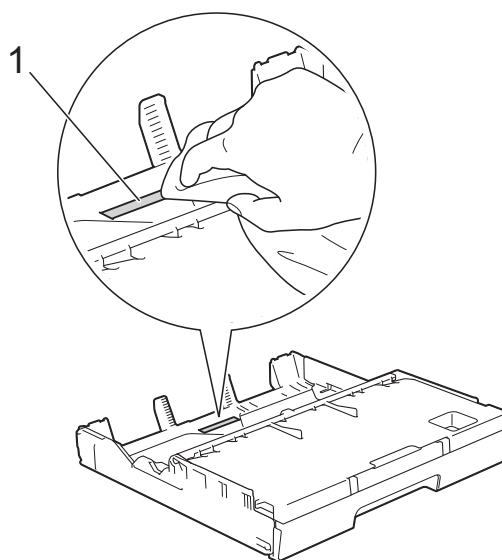

- 3 Lift the green Jam Clear Flap (1), and then clean the Paper Pick-up Rollers (2) with a soft lint-free cloth moistened with water.
Slowly turn the rollers so that the whole surface is cleaned.

After cleaning, wipe the rollers with a *dry*, soft, lint-free cloth to remove all moisture.

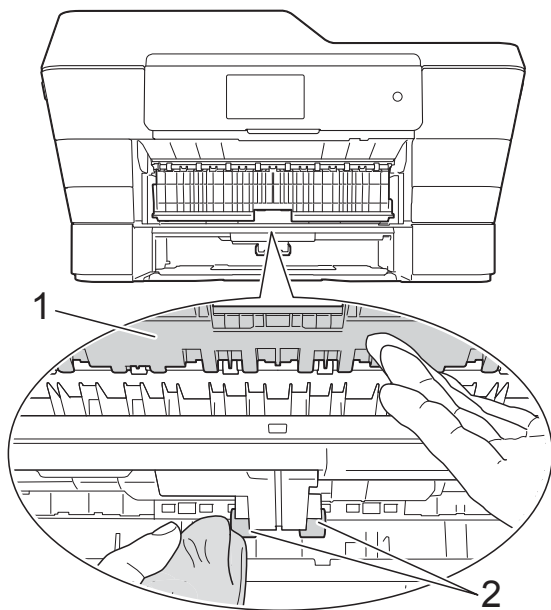

- 4 Put the paper tray firmly back in the machine.
- 5 Re-connect the power cord.

Cleaning the paper pick-up rollers for paper tray #2

- 1 Unplug the machine from the AC power outlet. Pull tray #2 completely out of the machine.

NOTE

If the paper support flap is open, close it, and then close the paper support.

- 2 Clean the paper pick-up rollers for tray #2 (1) with a soft lint-free cloth moistened with water.
Slowly turn the rollers so that the whole surface is cleaned.

After cleaning, wipe the rollers with a *dry*, soft, lint-free cloth to remove all moisture.

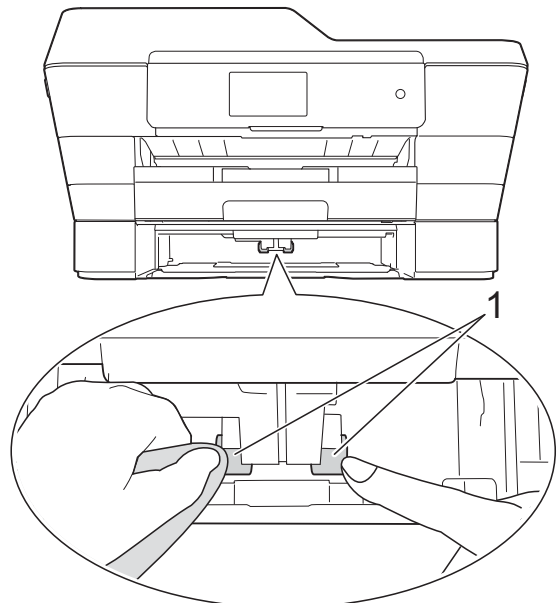

- 3 Put tray #2 firmly back in the machine.
- 4 Re-connect the power cord.

Checking the ink volume

Although an ink volume icon appears on the Touchscreen, you can use the ink menu to see a large graph showing the ink that is left in each cartridge.

- 1 Press .

NOTE

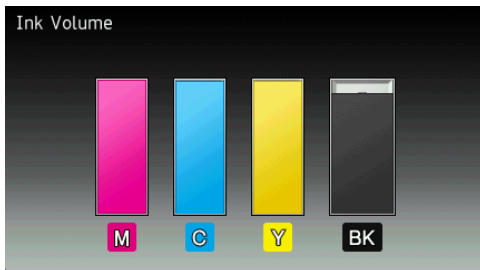

You can also press  and Ink.

- 2 Press Ink Volume.
The Touchscreen shows the ink volume.



NOTE

When the ink cartridge is near the end of its life or having a problem, one of the following icons is displayed.

	The ink level is low.
	The ink cartridge is empty.
	There is a problem with the ink cartridge.

- 3 Press .

NOTE

You can check the ink volume from your computer.

For more information, see *Software and Network User's Guide: Monitor the Ink Level and Status of the Machine from Your Computer (Windows®)* or *Monitor Machine Status from Your Computer (Macintosh)*.

Packing and shipping the machine

When you transport the machine, use the packing materials that came with your machine. If you do not pack the machine correctly, any damage that may occur in transit may not be covered by your warranty.

The machine should be adequately insured with the carrier.

IMPORTANT

It is important to allow the machine to "park" the print head after a print job. Listen carefully to the machine before unplugging it to make sure that all mechanical noises have stopped and the print head is in the right corner as shown in the illustration. Not allowing the machine to finish this parking process may lead to print problems and possible damage to the print head.

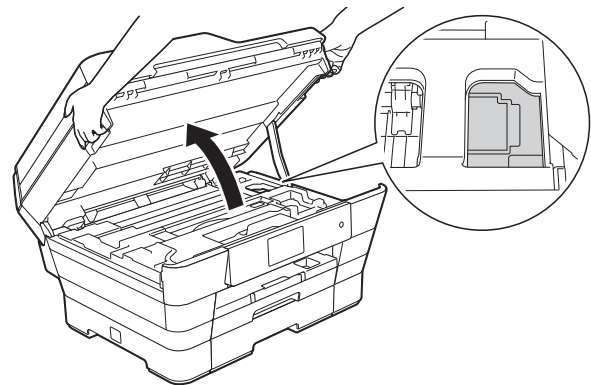

- 1 Unplug the machine from the AC power outlet.
- 2 Using both hands, use the finger holds on each side of the machine to lift the scanner cover into the open position. Then unplug the machine from the telephone wall jack and take the telephone line cord out of the machine.
- 3 Unplug the interface cable from the machine, if it is connected.

- 4 Remove the orange protective part from its storage place inside the right corner of the machine.

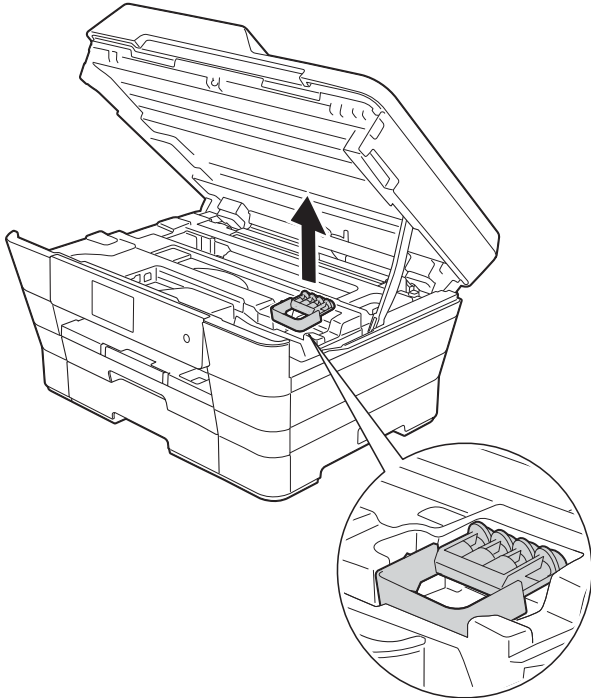

- 5 Gently close the scanner cover using the finger holds on each side.

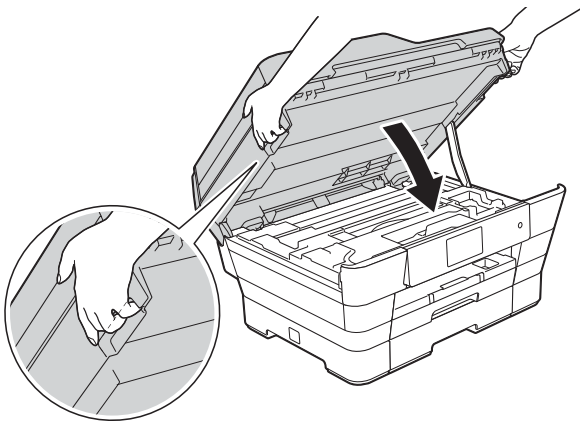

⚠ CAUTION

Be careful not to pinch your fingers when you close the scanner cover.

Always use the finger holds provided on each side of the scanner cover when opening and closing it.

- 6 Open the ink cartridge cover.
- 7 Press the ink release levers to release the ink cartridges, and then take out the ink cartridges. (See Basic User's Guide: *Replacing the ink cartridges.*)
- 8 Install the orange protective part, and then close the ink cartridge cover.

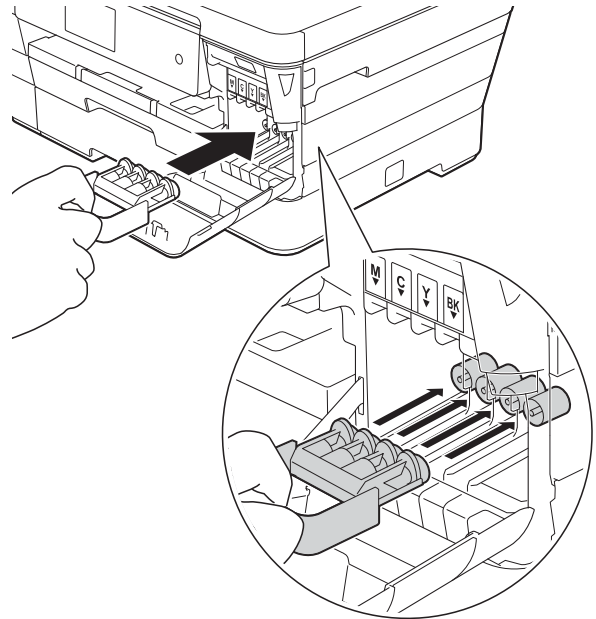

IMPORTANT

- Make sure the plastic tab on the left side of the orange protective part (1) locks securely into place (2).

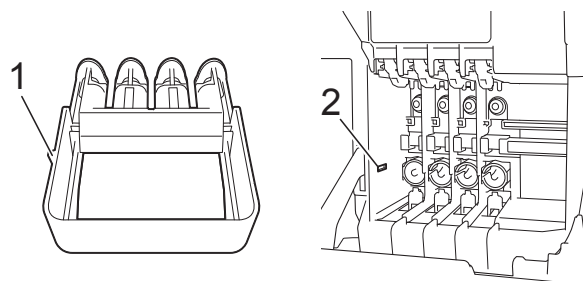

- If you cannot find the orange protective part, ship the machine without it. DO NOT install the ink cartridges as an alternative before shipping.

- 9 Wrap the machine in the bag.

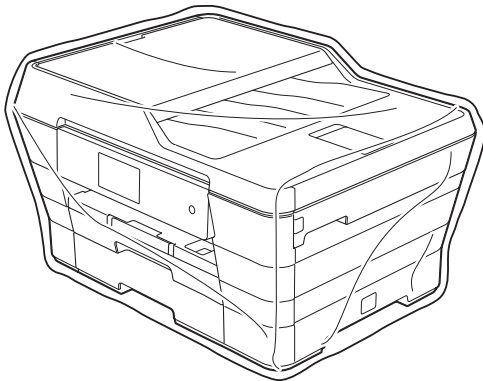

- 11 Close the carton and tape it shut.

- 10 Pack the machine and the printed materials in the original carton with the original packing material as shown below.
Do not pack the used ink cartridges in the carton.

NOTE

If you are returning your machine to Brother as part of the Exchange Service, pack *only* the machine. Keep all separate parts and printed materials to use with your “Exchange” machine.

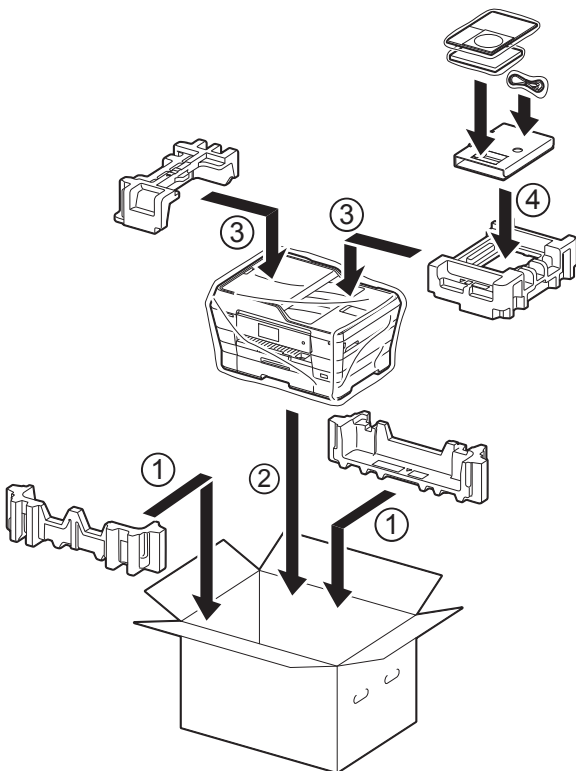

B

Glossary

This is a comprehensive list of features and terms that appear in Brother manuals. Availability of these features depends on the model you purchased.

3.7" Touchscreen LCD and Touchpanel

The Touchscreen LCD (Liquid Crystal Display) on the machine shows interactive messages and prompts for using the machine. You can operate the Touchscreen by pressing or swiping on the screen.

Address Book

Names and numbers you have stored for easy dialing.

Address Book List

A listing of names and numbers stored in the Address Book memory, in alphabetical order.

ADF (automatic document feeder)

The document can be placed in the ADF and scanned one page at a time automatically.

Auto Reduction

Reduces the size of incoming faxes.

Automatic Redial

A feature that enables your machine to redial the last fax number after five minutes if the fax did not go through because the line was busy.

Backup Print

Your machine prints a copy of every fax that is received and stored in its memory. This is a safety feature so you will not lose messages during a power failure.

Batch Transmission

(Black & white faxes only) As a cost-saving feature, all delayed faxes to the same fax number can be sent as one transmission.

Beep Volume

Volume setting for the beep when you press the Touchscreen or Touchpanel, make an error.

Brightness

Changing the Brightness makes the whole image lighter or darker.

Broadcasting

The ability to send the same fax message to more than one location.

Caller ID

A service purchased from the telephone company that lets you see the number (or name) of the party calling you.

CNG tones

The special tones (beeps) sent by fax machines during automatic transmission to tell the receiving machine that a fax machine is calling.

Coding method

Method of coding the information contained in the document. All fax machines must use a minimum standard of Modified Huffman (MH). Your machine is capable of greater compression methods, Modified Read (MR), Modified Modified Read (MMR) and JPEG, if the receiving machine has the same capability.

Color Enhancement

Adjusts the color in the image for better print quality by improving sharpness, white balance and color density.

Communication error (Comm. Error)

An error during fax sending or receiving, usually caused by line noise or static.

Compatibility group

The ability of one fax unit to communicate with another. Compatibility is assured between ITU-T Groups.

Contrast

Setting to compensate for dark or light documents, by making faxes or copies of dark documents lighter and light documents darker.

Delayed Fax

Sends your fax at a specified time later.

Density

Changing the Density makes the whole image lighter or darker.

Distinctive Ring

A subscriber service purchased from the telephone company that gives you another telephone number on an existing telephone line. The Brother machine uses the new number to simulate a dedicated fax line.

Dual Access

Your machine can scan outgoing faxes or scheduled jobs into the memory at the same time it is sending a fax from memory, receiving or printing an incoming fax.

Easy Receive

Enables your machine to respond to CNG tones if you interrupt a fax call by answering it.

ECM (Error Correction Mode)

Detects errors during fax transmission and resends the pages of the fax that had an error.

Extension telephone

A telephone using the same line as your fax but plugged into a separate wall jack.

External telephone

A telephone that is plugged into the EXT. jack of your machine.

F/T Ring Time

The length of time that the Brother machine rings (when the Receive Mode setting is Fax/Tel) to notify you to pick up a voice call that it answered.

Fax Forwarding

Sends a fax received into the memory to another pre-programmed fax number.

Fax Journal

Lists information about the last 200 incoming and outgoing faxes. TX means Transmit. RX means Receive.

Fax Receive Code

Press this code (* 5 1) when you answer a fax call on an extension or external telephone.

Fax Storage

You can store received faxes in memory.

Fax tones

The signals sent by sending and receiving fax machines while communicating information.

Fax/Tel

You can receive faxes and telephone calls. Do not use this mode if you are using a telephone answering device (TAD).

Fine resolution

Resolution is 203 × 196 dpi. It is used for small print and graphs.

Gray Scale

The shades of gray available for copying, scanning and faxing photographs.

Group number

A combination of Address Book numbers that are stored in Address Book for Broadcasting.

Journal Period

The pre-programmed time period between automatically printed Fax Journal reports. You can print the Fax Journal report on demand without interrupting the cycle.

Manual fax

You can press **Hook** to hear the receiving fax machine answer before you press **Fax Start** to begin sending.

Memory Receive

Receives faxes into the machine's memory when the machine is out of paper.

OCR (optical character recognition)

Nuance™ PaperPort™ 12SE or Presto! PageManager software application converts an image of text to text you can edit.

Overseas Mode

Makes temporary changes to the fax tones to accommodate noise and static on overseas telephone lines.

Paging

This feature enables your machine to call your cell phone or pager when a fax is received into its memory.

Pause

Allows you to place a 3.5 second delay in the dialing sequence while you are dialing using the dial pad or while you are storing Address Book numbers. Press **Pause** on the Touchscreen as many times as needed for longer pauses.

PhotoCapture Center™

Allows you to print digital photos from your digital camera at high resolution for photo quality printing.

Photo resolution (B&W only)

A resolution setting that uses varying shades of gray for the best representation of photographs.

PictBridge

Allows you to print photos directly from your digital camera at high resolution for photo quality printing.

Polling

The process of a fax machine calling another fax machine to retrieve waiting fax messages.

Pulse (Canada only)

A form of rotary dialing on a telephone line.

Real Time Transmission

When the memory is full, you can send faxes in real time.

Remaining jobs

You can check which jobs are waiting in memory and cancel jobs individually.

Remote Access Code

Your own four-digit code (---*) that allows you to call and access your machine from a remote location.

Remote Retrieval Access

The ability to access your machine remotely from a touch-tone telephone.

Resolution

The number of vertical and horizontal lines per inch. (See Standard resolution, Fine resolution, Super Fine resolution and Photo resolution.)

Ring Delay

The number of rings before the machine answers in **Fax Only** and **Fax/Tel** modes.

Ring Volume

Volume setting for the machine's ring.

Scanning

The process of sending an electronic image of a paper document to your computer.

Scan to Media

You can scan a black & white or color document onto a memory card or USB Flash drive. Black & white images can be in the TIFF or PDF file format and color images can be in the PDF or JPEG file format.

Search

An alphabetical electronic listing of stored Address Book and Group numbers.

Settings Tables

At-a-glance instructions that show all the settings and options that are available for setting up your machine.

Standard resolution

203 × 98 dpi (black & white).

203 × 196 dpi (color). It is used for regular sized text and the quickest transmission.

Station ID

The stored information that appears on the top of faxed pages. It includes the sender's name and fax number.

Super Fine resolution (B&W)

203 × 392 dpi. Best for very small print and line art.

TAD (telephone answering device)

You can connect an external telephone answering device or answering machine to the EXT. jack of your machine.

Telephone Answer Code (For Fax/Tel mode only)

When the machine answers a voice call, it pseudo/double-rings. You can pick up at an extension telephone by pressing this code (**# 5 1**).

Temporary settings

You can choose certain options for each fax transmission and copy without changing the default settings.

Tone

A form of dialing on the telephone line used for touch-tone telephones.

Transmission

The process of sending faxes over the phone lines from your machine to the receiving fax machine.

Transmission Verification Report

A listing for the last fax sent, that shows its date, time and number.

User Settings

A printed report that shows the current settings of the machine.

WLAN Report

A printed report that shows the result of the WLAN Connection.

Numerics

2 in 1 ID Copy	47
2-sided	
copy	53
fax	15

A

Access codes, storing and dialing	36
Address Book	
Access codes and credit card	
numbers	36
Broadcasting	16
deleting Groups	39
using Groups	16
Group dial	
changing	38
setting up Groups for Broadcasting ...	38
setting up from Caller ID history	37
setting up from outgoing calls	37
Apple Macintosh	
See Software and Network User's Guide.	

B

Broadcasting	16
setting up Groups for	38

C

Caller ID	32
Caller ID history	35
Add to Address Book	35
Delete	35
Send a fax	35
Caller ID History report	41
Setting up your area code	33
Canceling	
Fax Forwarding	24, 27
Fax Storage	24
jobs awaiting redial	20
Paging	24, 27
Cleaning	
paper feed rollers	81
paper pick-up rollers	82
printer platen	80

Connecting	
two-line external TAD or telephone	34
ControlCenter	
See Software and Network User's Guide.	
Copy	
2 in 1 ID	47
2-sided	53
book	51
density	48
enlarge/reduce	43
ink save mode	49
Ledger shortcut	55
page layout (N in 1)	44
poster	44
quality	42
remove background color	52
sort (ADF only)	48
thin paper	50
using ADF	48
Watermark	51
using a template	51

D

Dialing	
access codes and credit card	
numbers	36
Caller ID history	35
dial prefix	5
Groups (Broadcasting)	16
Outgoing Call	35
restricting dialing	9
Direct printing	
from a non-PictBridge camera	77
from a PictBridge camera	75
Dual Access	16

F	
<hr/>	
Fax codes	
changing	26
Remote Access Code	26
Fax Forwarding	
changing remotely	27, 28
programming a number	22
Fax Storage	23
printing from memory	24
turning off	24
turning on	23
Fax, from PC	
See Software and Network User's Guide.	
Fax, stand-alone	
receiving	
at end of conversation	29
Fax Forwarding	27
into the memory	29
out of paper reception	29
Paging	23
printing from memory	24
reducing to fit on paper	29
retrieving from a remote site	27, 28
sending	11
2-sided	15
at end of conversation	16
Broadcasting	16
canceling from memory	20
contrast	12
delayed batch transmission	20
delayed fax	19
from memory (Dual Access)	16
manual	15
overseas	19
Real Time Transmission	18
Resolution	12
return to factory setting	14
set new default	13
Function Lock	6
G	
<hr/>	
Groups for Broadcasting	38
I	
<hr/>	
ID Copy	47
Ink cartridges	
checking ink volume	84
J	
<hr/>	
Jacks	
Convert to RJ11 jack triplex adapter	34
EXT	
TAD	34
L	
<hr/>	
LCD (Liquid Crystal Display)	
Brightness	4
M	
<hr/>	
Macintosh	
See Software and Network User's Guide.	
Manual	
transmission	15
Memory Storage	1
Movie printing	59
N	
<hr/>	
Network	
Printing	
See Software and Network User's Guide.	
Scanning	
See Software and Network User's Guide.	
Nuance™ PaperPort™ 12SE	
See Software and Network User's Guide.	
See also Help in the PaperPort™ 12SE application.	
O	
<hr/>	
Outgoing Call	
Add to Address Book	35
Delete	35
Send a fax	35

P

Packing and shipping the machine	84
Paging	23
PhotoCapture Center™	
Adding Effect	60
DPOF printing	64
from PC	
See Software and Network User's Guide.	
ID photo	62
Photo Effects	
Auto Correct	60, 61
Crop	60, 61, 62
Enhance Scenery	60, 61
Enhance Skin	60, 61
Fill Light	60, 61
Monochrome	60, 61
Night Scene	60, 61
Remove Red-Eye	60, 61
Sepia	60, 61
Whiteboard	60, 61
Print settings	
Borderless	70
Brightness	67
Color Enhancement	68
Contrast	68
Cropping	69
Paper Size and Print Size	66
Paper Type	65
Print Date	70
Quality	65
Return to factory setting	71
rotate	62, 63
Set new default	71
Printing	
index	59
photos	60
Scan to Media	
auto crop	72
memory card	72
USB Flash drive	72
Slide-Show	63
PictBridge	75
DPOF Printing	77
Power failure	1
Presto! PageManager	
See Software and Network User's Guide.	
See also Help in the Presto! PageManager application.	

Print	
fax from memory	24
report	41
Printing	
See Software and Network User's Guide.	

R

Reducing	
copies	43
incoming faxes	29
Remote Retrieval	26
commands	27
getting your faxes	28
Remote Access Code	26
Remote Setup	
See Software and Network User's Guide.	
Reports	40
Address Book	41
Caller ID History Report	41
Fax Journal	41
Journal Period	40
how to print	41
Network Configuration	41
Transmission Verification	40, 41
User Settings	41
WLAN Report	41
Resolution	
setting for next fax	12
Restricted users	8

S

Scanning	
See Software and Network User's Guide.	
Security	
Secure function lock	
administrator password	7
restricted users	8
Shipping the machine	84
Sleep Mode	3

T

TAD (telephone answering device),	
external	34
with two-line jack	34
Telephone line	
roll over lines	33
two-line telephone system	33
Troubleshooting	
checking ink volume	84
Two-line telephone system	33

V

Volume, setting	
beep	2
ring	1
speaker	2

W

Warranties are in the box	
Windows®	
See Software and Network User's Guide.	
Wireless Network	
See Quick Setup Guide and Software and Network User's Guide.	

Brother International Corporation
200 Crossing Boulevard
P.O. Box 6911
Bridgewater, NJ 08807-0911 USA

Brother International Corporation (Canada) Ltd.
1 rue Hôtel de Ville,
Dollard-des-Ormeaux, QC, Canada H9B 3H6

brother

Visit us on the World Wide Web
<http://www.brother.com/>

These machines are approved for use in the country of purchase only. Local Brother companies or their dealers will only support machines purchased in their own countries.



www.brotherearth.com

Free Manuals Download Website

<http://myh66.com>

<http://usermanuals.us>

<http://www.somanuals.com>

<http://www.4manuals.cc>

<http://www.manual-lib.com>

<http://www.404manual.com>

<http://www.luxmanual.com>

<http://aubethermostatmanual.com>

Golf course search by state

<http://golfingnear.com>

Email search by domain

<http://emailbydomain.com>

Auto manuals search

<http://auto.somanuals.com>

TV manuals search

<http://tv.somanuals.com>