

Read the *Product Safety Guide* first, then read this guide for the correct installation procedure. Keep this guide next to your machine for quick reference.

You must follow steps 1 to 7 to complete the setup.

### 1 Unpack the machine and check the components

Remove the protective tape and the film covering the machine.

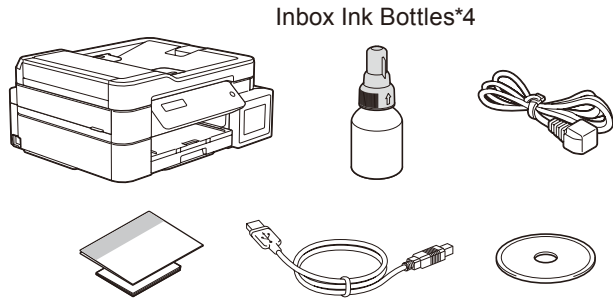

#### NOTE

- The illustrations in this *Quick Setup Guide* show the DCP-T720DW.
- Save all packing materials and the box in case you must ship your machine.
- We recommend using a USB 2.0 cable (Type A/B) that is no more than 2 meters long.
- Use a straight-through Category 5 (or greater) twisted-pair cable for 10BASE-T or 100BASE-TX Fast Ethernet Network (not included). (DCP-T820DW)

#### Operation Videos

[www.95105369.com](http://www.95105369.com)



Installation  
& Using  
Videos

### 2 Load plain A4 paper in the paper tray

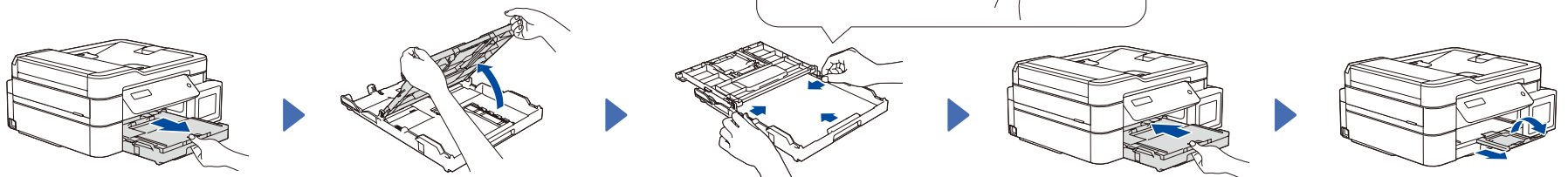

### 3 Connect the power cord

Connect the power cord. The machine powers on automatically.

### 4 Fill the ink tanks with inbox ink

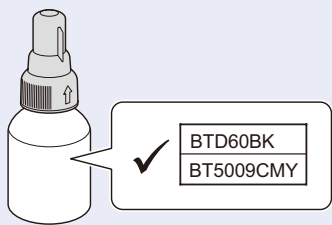

#### IMPORTANT

Check the ink bottle model name on the label. Using the incorrect ink may cause damage to the machine.

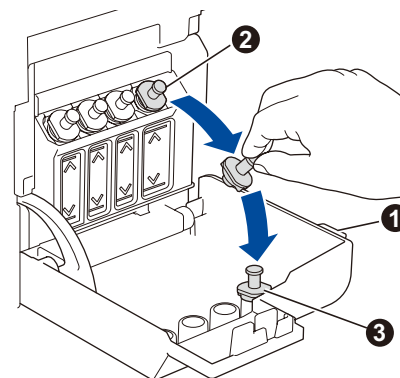

Open the ink tank cover ①, remove the cap ②, and place it on the back of the cover ③.

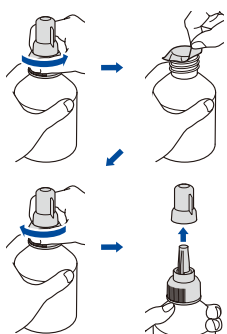

Remove the film and tighten the cap firmly.

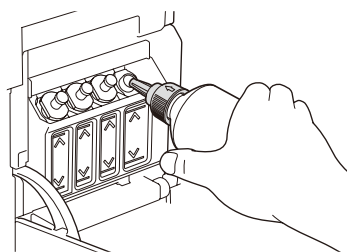

Remove the nozzle cap and insert the bottle nozzle firmly into the ink tank so that the ink does not spill.

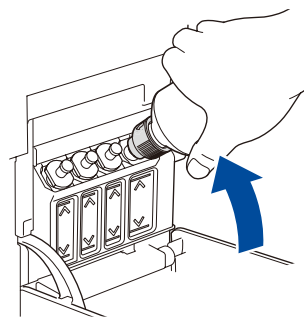

The bottle is self-standing and the ink fills automatically until the bottle is empty. To fill the ink tank faster, squeeze the bottle on both sides.

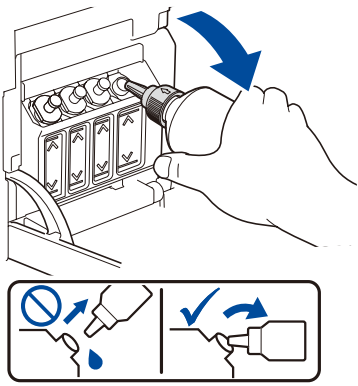

When finished, remove the bottle, pointing the nozzle upward so the ink does not spill.

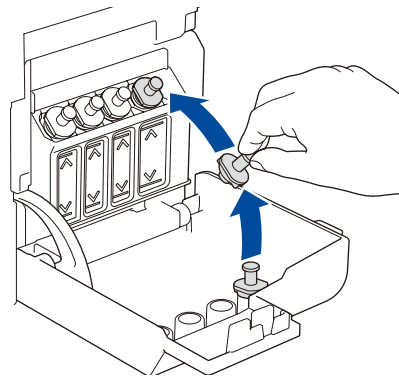

Replace the ink tank cap. Repeat step 4 for the other ink tanks, and then close the ink tank cover.

## 5 Set the date and time

1. Press **OK** to set the date and time.
2. Press **▲** or **▼** to select the number, and then press **OK** to set the date and time.

## 6 Machine settings

When the machine has finished the initial cleaning process, follow the steps on the LCD to configure the machine settings.

- Check the print quality

DCP-T820DW:  
• Configure the paper tray settings

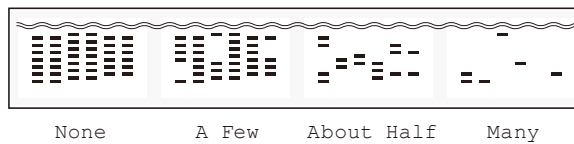

## 7 Connect your computer or mobile device

Connect your Brother machine and computer/mobile device to the same network.

Install Brother software to use your machine. Visit one of the following websites:

**For Computers:**

[setup.brother.com](http://setup.brother.com)

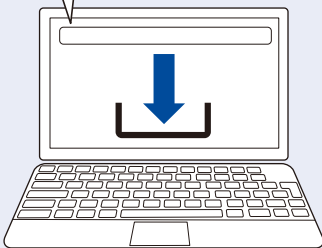

For Windows only, CD installation is also available.

**For Mobile Devices:**

[brother.com/apps](http://brother.com/apps)



Install the **Brother iPrint&Scan** application.

Follow the on-screen instructions.

**For Wired Network Connection\* and USB Connection:**  
Use the correct port (based on the cable you are using) inside the machine, as shown.

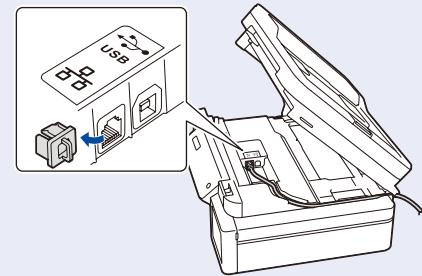

\*DCP-T820DW

### Manual wireless setup (if needed)

Find the SSID (Network Name) and Network Key (Password) on your wireless access point/router.

SSID: XXXXXXXX  
Network Key: XXXX

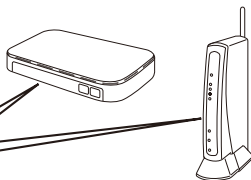

If you cannot find this information, ask your network administrator or wireless access point/router manufacturer.

1. Go to your machine and press **WiFi**.
2. Press **OK** to select [Find Network].  
The [WLAN Enable?] message appears on the LCD.
3. Press **▲** to select [On].

Select the SSID (Network Name) for your access point/router and enter the Network Key (Password). To enter the Network Key, hold down or repeatedly press **▲** or **▼** to select a character from the list below:

abcdefghijklmnopqrstuvwxyzABCDEFGHIJKLMNOPQRSTUVWXYZ  
STUVWXYZ0123456789(space)!"#%&'()\*+,-./:;<=>?@  
[ ] ^ \_ { } ~

When the wireless setup is successful, the LCD displays [Connected].

## 兄弟畅享印(WeChat Mini Program)

Your machine can print through an applet of WeChat, which is called "兄弟畅享印". "兄弟畅享印" lets you wirelessly print photos and documents without the need to install an app or a driver.  
Binding your printer before using above print function for the first time.  
Please scan the QR code on the right for operation instructions.



## Reference and Troubleshooting



For detailed machine operation, see the *Online User's Guide*:

[www.95105369.com](http://www.95105369.com)



Using &  
Troubleshooting

## Control Panel Overview



### ■ Copy

1. Place the document **face down** on the scanner glass.
2. Press **Mono Start** or **Color Start**.

Note: For multiple Copy, press ▲ or ▼ to select the number of Copies.

### ■ Copy Options

Enlarge or reduce copies, adjust density, ID copy and so on settings, press **Enlarge/Reduce** or **Copy Quality** or **Copy/Scan Options(ID)** in advance.

### ■ Scan

1. Place the document **face down** on the scanner glass.
2. Press **SCAN**.
3. Follow the on-screen instructions, press ▲ or ▼ to select scanning file format and the computer where you send data, and then press **OK**.
4. Press **Mono Start** or **Color Start**.

### ■ Scan Options

There are Scan type, Resolution, File Type, Document Size, Remove background colour and so on settings.  
Press **SCAN**, and then press **Copy/Scan Options(ID)** for more scan settings.

## Machine Settings

The machine's settings are set from the application (**Brother iPrint&Scan** or **Brother Utilities**) on your computer or mobile device.

**Important Notice for Network Security:** The default password to manage this machine's settings is located on the back of the machine and marked "Pwd". We recommend immediately changing the default password to protect your machine from unauthorized access. See the *Online User's Guide*.

## Check Ink Volume

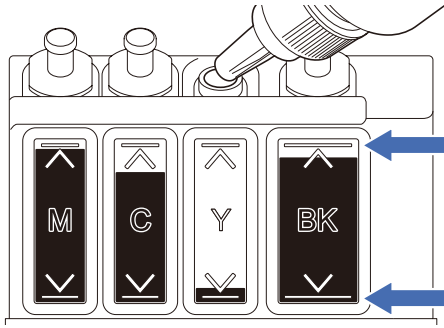

DO NOT fill the ink tank past the maximum fill mark.

When the ink level reaches the lower line, refill the ink tank as soon as possible.

## Improve Print Quality

Clean the print head.

Press **Menu**.

Press ▲ or ▼ to select [Maintenance] > [Cleaning] > [Black], [Color] or [All] > [Normal], [Strong] or [Strongest], and then press **OK**.

Press **Mono Start** or **Color Start**.

## Remove Jammed Paper

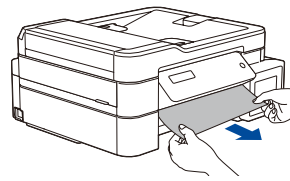
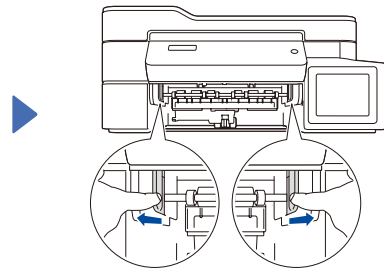
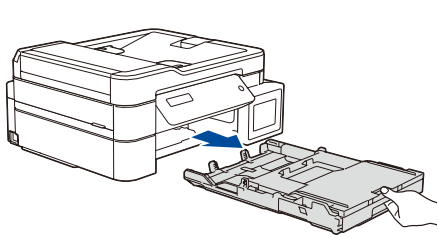

Avoid getting ink on your hands.

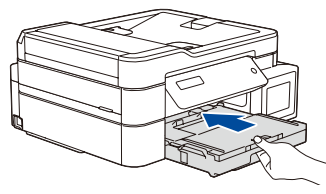
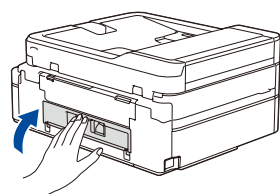
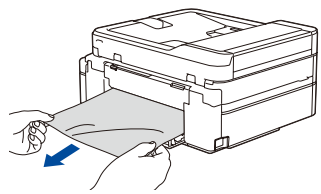
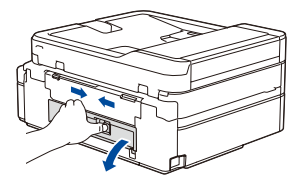
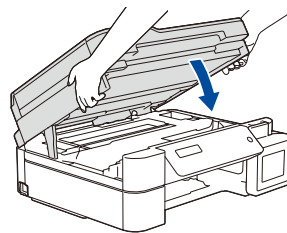
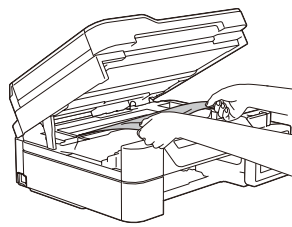
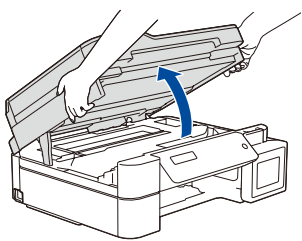

For more information about paper jams, see the *Online User's Guide*.

## Free Manuals Download Website

<http://myh66.com>

<http://usermanuals.us>

<http://www.somanuals.com>

<http://www.4manuals.cc>

<http://www.manual-lib.com>

<http://www.404manual.com>

<http://www.luxmanual.com>

<http://aubethermostatmanual.com>

Golf course search by state

<http://golfingnear.com>

Email search by domain

<http://emailbydomain.com>

Auto manuals search

<http://auto.somanuals.com>

TV manuals search

<http://tv.somanuals.com>