

ASUS[®]

VK228/VS229 series LCD Monitor

User Guide

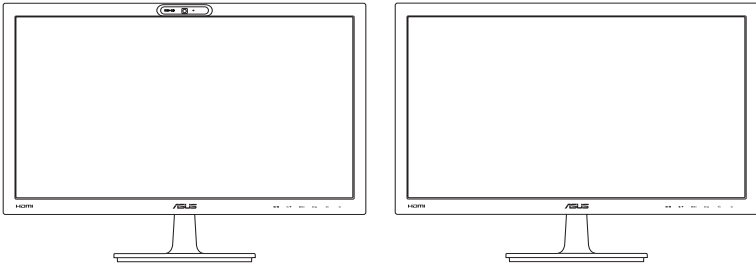

HDMI[™]
HIGH DEFINITION MULTIMEDIA INTERFACE

Copyright © 2013 ASUSTeK COMPUTER INC. All Rights Reserved.

No part of this manual, including the products and software described in it, may be reproduced, transmitted, transcribed, stored in a retrieval system, or translated into any language in any form or by any means, except documentation kept by the purchaser for backup purposes, without the express written permission of ASUSTeK COMPUTER INC. ("ASUS").

Product warranty or service will not be extended if: (1) the product is repaired, modified or altered, unless such repair, modification or alteration is authorized in writing by ASUS; or (2) the serial number of the product is defaced or missing.

ASUS PROVIDES THIS MANUAL "AS IS" WITHOUT WARRANTY OF ANY KIND, EITHER EXPRESS OR IMPLIED, INCLUDING BUT NOT LIMITED TO THE IMPLIED WARRANTIES OR CONDITIONS OF MERCHANTABILITY OR FITNESS FOR A PARTICULAR PURPOSE. IN NO EVENT SHALL ASUS, ITS DIRECTORS, OFFICERS, EMPLOYEES OR AGENTS BE LIABLE FOR ANY INDIRECT, SPECIAL, INCIDENTAL, OR CONSEQUENTIAL DAMAGES (INCLUDING DAMAGES FOR LOSS OF PROFITS, LOSS OF BUSINESS, LOSS OF USE OR DATA, INTERRUPTION OF BUSINESS AND THE LIKE), EVEN IF ASUS HAS BEEN ADVISED OF THE POSSIBILITY OF SUCH DAMAGES ARISING FROM ANY DEFECT OR ERROR IN THIS MANUAL OR PRODUCT.

SPECIFICATIONS AND INFORMATION CONTAINED IN THIS MANUAL ARE FURNISHED FOR INFORMATIONAL USE ONLY, AND ARE SUBJECT TO CHANGE AT ANY TIME WITHOUT NOTICE, AND SHOULD NOT BE CONSTRUED AS A COMMITMENT BY ASUS. ASUS ASSUMES NO RESPONSIBILITY OR LIABILITY FOR ANY ERRORS OR INACCURACIES THAT MAY APPEAR IN THIS MANUAL, INCLUDING THE PRODUCTS AND SOFTWARE DESCRIBED IN IT.

Products and corporate names appearing in this manual may or may not be registered trademarks or copyrights of their respective companies, and are used only for identification or explanation and to the owners' benefit, without intent to infringe.

Contents

Notices.....	iv
Safety information	v
Care & Cleaning.....	vi
Takeback Services.....	vii
Chapter 1: Product introduction	
1.1 Welcome!	1-1
1.2 Package contents.....	1-1
1.3 LifeFrame 2 software	1-1
Installation instructions.....	1-1
1.4 Monitor introduction.....	1-2
1.4.1 Front view	1-2
1.4.2 Back view.....	1-4
1.4.3 QuickFit Function (VK228H/VK228S/VK228T).....	1-4
Chapter 2: Setup	
2.1 Assembling the monitor arm/base	2-1
2.2 Adjusting the monitor.....	2-1
2.3 Detaching the arm/base (for VESA wall mount).....	2-2
2.4 Connecting the cables.....	2-3
2.5 Turning on the monitor.....	2-3
Chapter 3: General instructions	
3.1 OSD (On-Screen Display) menu	3-1
3.1.1 How to reconfigure.....	3-1
3.1.2 OSD function introduction.....	3-1
3.2 Specifications summary (VK228H).....	3-4
Specifications summary (VK228T).....	3-5
Specifications summary (VK228S).....	3-6
Specifications summary (VS229).....	3-7
3.3 Troubleshooting (FAQ).....	3-8
3.4 Supported operating modes	3-9

Notices

Federal Communications Commission Statement

This device complies with Part 15 of the FCC Rules. Operation is subject to the following two conditions:

- This device may not cause harmful interference, and
- This device must accept any interference received including interference that may cause undesired operation.

This equipment has been tested and found to comply with the limits for a Class B digital device, pursuant to Part 15 of the FCC Rules. These limits are designed to provide reasonable protection against harmful interference in a residential installation. This equipment generates, uses and can radiate radio frequency energy and, if not installed and used in accordance with the instructions, may cause harmful interference to radio communications. However, there is no guarantee that interference will not occur in a particular installation. If this equipment does cause harmful interference to radio or television reception, which can be determined by turning the equipment off and on, the user is encouraged to try to correct the interference by one or more of the following measures:

- Reorient or relocate the receiving antenna.
- Increase the separation between the equipment and receiver.
- Connect the equipment into an outlet on a circuit different from that to which the receiver is connected.
- Consult the dealer or an experienced radio/TV technician for help.



The use of shielded cables for connection of the monitor to the graphics card is required to assure compliance with FCC regulations. Changes or modifications to this unit not expressly approved by the party responsible for compliance could void the user's authority to operate this equipment.



As an Energy Star® Partner, our company has determined that this product meets the Energy Star® guidelines for energy efficiency. (VK228H-CSM)

Canadian Department of Communications Statement

This digital apparatus does not exceed the Class B limits for radio noise emissions from digital apparatus set out in the Radio Interference Regulations of the Canadian Department of Communications.

This class B digital apparatus complies with Canadian ICES-003.

This Class B digital apparatus meets all requirements of the Canadian Interference - Causing Equipment Regulations.

Cet appareil numérique de la classe B respecte toutes les exigences du Règlement sur le matériel brouiller du Canada.



Safety information

- Before setting up the monitor, carefully read all the documentation that came with the package.
- To prevent fire or shock hazard, never expose the monitor to rain or moisture.
- Never try to open the monitor cabinet. The dangerous high voltages inside the monitor may result in serious physical injury.
- If the power supply is broken, do not try to fix it by yourself. Contact a qualified service technician or your retailer.
- Before using the product, make sure all cables are correctly connected and the power cables are not damaged. If you detect any damage, contact your dealer immediately.
- Slots and openings on the back or top of the cabinet are provided for ventilation. Do not block these slots. Never place this product near or over a radiator or heat source unless proper ventilation is provided.
- The monitor should be operated only from the type of power source indicated on the label. If you are not sure of the type of power supply to your home, consult your dealer or local power company.
- Use the appropriate power plug which complies with your local power standard.
- Do not overload power strips and extension cords. Overloading can result in fire or electric shock.
- Avoid dust, humidity, and temperature extremes. Do not place the monitor in any area where it may become wet. Place the monitor on a stable surface.
- Unplug the unit during a lightning storm or if it will not be used for a long period of time. This will protect the monitor from damage due to power surges.
- Never push objects or spill liquid of any kind into the slots on the monitor cabinet.
- To ensure satisfactory operation, use the monitor only with UL listed computers which have appropriate configured receptacles marked between 100-240V AC.
- If you encounter technical problems with the monitor, contact a qualified service technician or your retailer.
- Adjustment of the volume control as well as the equalizer to other settings than the center position may increase the ear-/headphones output voltage and therefore the sound pressure level.



This symbol of the crossed out wheeled bin indicates that the product (electrical, electronic equipment, and mercury-containing button cell battery) should not be placed in municipal waste. Please check local regulations for disposal of electronic products.

AEEE yönetmeliğine uygundur

Care & Cleaning

- Before you lift or reposition your monitor, it is better to disconnect the cables and power cord. Follow the correct lifting techniques when positioning the monitor. When lifting or carrying the monitor, grasp the edges of the monitor. Do not lift the display by the stand or the cord.
- Cleaning. Turn your monitor off and unplug the power cord. Clean the monitor surface with a lint-free, non-abrasive cloth. Stubborn stains may be removed with a cloth dampened with mild cleaner.
- Avoid using a cleaner containing alcohol or acetone. Use a cleaner intended for use with the monitor. Never spray cleaner directly on the screen, as it may drip inside the monitor and cause an electric shock.

The following symptoms are normal with the monitor:

- The screen may flicker during the initial use due to the nature of the fluorescent light. Turn off the Power Switch and turn it on again to make sure that the flicker disappears.
- You may find slightly uneven brightness on the screen depending on the desktop pattern you use.
- When the same image is displayed for hours, an afterimage of the previous screen may remain after switching the image. The screen will recover slowly or you can turn off the Power Switch for hours.
- When the screen becomes black or flashes, or cannot work anymore, contact your dealer or service center to fix it. Do not repair the screen by yourself!

Conventions used in this guide



WARNING: Information to prevent injury to yourself when trying to complete a task.



CAUTION: Information to prevent damage to the components when trying to complete a task.



IMPORTANT: Information that you **MUST** follow to complete a task.



NOTE: Tips and additional information to aid in completing a task.

Where to find more information

Refer to the following sources for additional information and for product and software updates.

1. **ASUS websites**

The ASUS websites worldwide provide updated information on ASUS hardware and software products. Refer to <http://www.asus.com>

2. **Optional documentation**

Your product package may include optional documentation that may have been added by your dealer. These documents are not part of the standard package.

Takeback Services

ASUS recycling and takeback programs come from our commitment to the highest standards for protecting our environment. We believe in providing solutions for our customers to be able to responsibly recycle our products, batteries and other components as well as the packaging materials.

Please go to <http://csr.asus.com/english/Takeback.htm> for detail recycling information in different region.

Congratulations!

This product is TCO Certified – for Sustainable IT



TCO Certified is an international third party sustainability certification for IT products. TCO Certified ensures that the manufacture, use and recycling of IT products reflect environmental, social and economic responsibility. Every TCO Certified product model is verified by an accredited independent test laboratory.

This product has been verified to meet all the criteria in TCO Certified, including:

Corporate Social Responsibility

Socially responsible production - working conditions and labor law in manufacturing country

Energy Efficiency

Energy efficiency of product and power supply. Energy Star compliant, where applicable

Environmental Management System

Manufacturer must be certified according to either ISO 14001 or EMAS

Minimization of Hazardous Substances

Limits on cadmium, mercury, lead & hexavalent chromium including requirements for mercury-free products, halogenated substances and hazardous flame retardants

Design for Recycling

Coding of plastics for easy recycling. Limit on the number of different plastics used.

Product Lifetime, Product Take Back

Minimum one-year product warranty. Minimum three-year availability of spare parts. Product takeback

Packaging

Limits on hazardous substances in product packaging. Packaging prepared for recycling

Ergonomic, User-centered design

Visual ergonomics in products with a display. Adjustability for user comfort (displays, headsets)

Acoustic performance – protection against sound spikes (headsets) and fan noise (projectors, computers)

Ergonomically designed keyboard (notebooks)

Electrical Safety, minimal electro-magnetic Emissions

Third Party Testing

All certified product models have been tested in an independent, accredited laboratory.

A detailed criteria set is available for download at www.tcodevelopment.com, where you can also find a searchable database of all TCO Certified IT products.

TCO Development, the organization behind TCO Certified, has been an international driver in the field of Sustainable IT for 20 years. Criteria in TCO Certified are developed in collaboration with scientists, experts, users and manufacturers. Organizations around the world rely on TCO Certified as a tool to help them reach their sustainable IT goals. We are owned by TCO, a non-profit organization representing office workers. TCO Development is headquartered in Stockholm, Sweden, with regional presence in North America and Asia.

For more information, please visit
www.tcodevelopment.com

1.1 Welcome!

Thank you for purchasing the ASUS® LCD monitor!

The latest widescreen LCD monitor from ASUS provides a broader, brighter and crystal-clear display, plus a host of features that enhance your viewing experience.

With these features, you can enjoy the convenience and delightful visual experience that the monitor brings to you!

1.2 Package contents

Check your package for the following items:

- ✓ LCD monitor
- ✓ Monitor base
- ✓ Quick start guide
- ✓ Warranty card
- ✓ Power cord
- ✓ VGA cable
- ✓ DVI cable (VK228H/VK228T/VS229)
- ✓ USB cable (VK228H/VK228S/VK228T)
- ✓ Audio cable (VK228H/VK228S/VK228T)
- ✓ LifeFrame 2 CD (VK228H/VK228S/VK228T)



If any of the above items is damaged or missing, contact your retailer immediately.

1.3 LifeFrame 2 software

ASUS VK228 provides the easy-to-use LifeFrame 2 software that can work with the webcam, allowing users to create their own photos or video clips.

Installation instructions



- LifeFrame 2 only supports Microsoft® Windows® 7/ Vista / XP Service Pack 2 (3) operating systems.
 - The LifeFrame 2 software is bundled in the support CD.
-





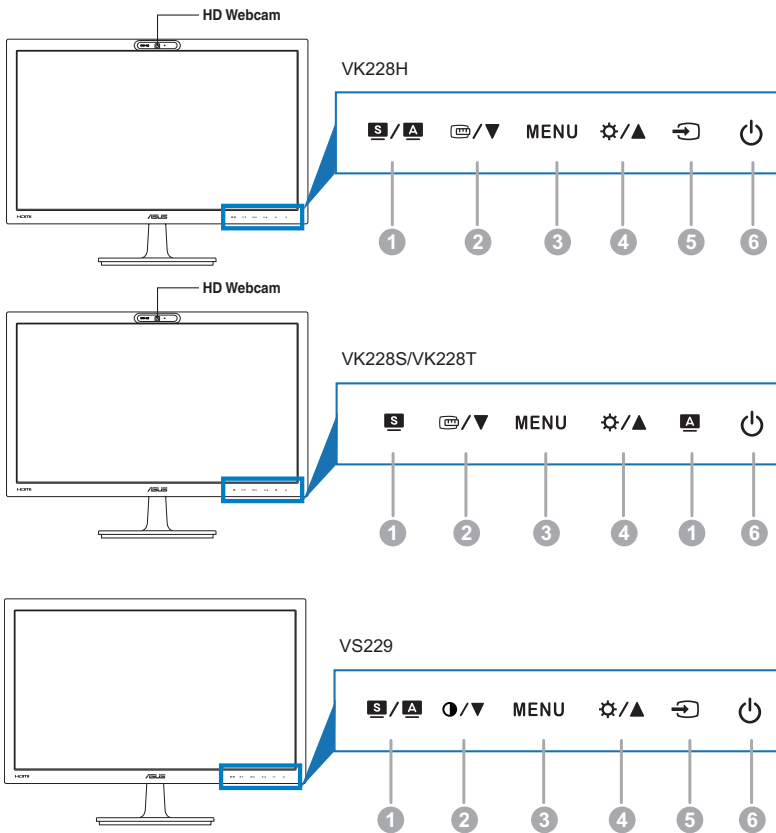

1. Close all other applications.
2. Insert the support CD into the optical drive and run the LifeFrame 2 program.
3. Follow the on-screen instructions to complete the installation.

1.4 Monitor introduction

1.4.1 Front view



1. **S / A, S, A** button:
 - Selects a desired preset mode. (**S / A, S**)
 - Exits the OSD menu or goes back to the previous menu when the OSD menu is active. (**S / A, S**)
 - Automatically adjusts the image to its optimized position, clock, and phase by pressing this button for 2-4 seconds (for VGA mode only). (**S / A, A**)
2. **TV / Down Arrow, TV / Up Arrow**
 - Decreases values or moves your selection left/down.

- Activates the QuickFit function.(Please refer to 1.4.3 QuickFit Function).
( / )
 - Contrast hotkey. ( / )
3. MENU button:
- Turns on the OSD menu. Enacts the selected OSD menu item.
4.  / 
- Increases values or moves your selection right/up.
 - Brightness hotkey
5.  button:
- Selects an available input source.



Press  (Input Select button) to display HDMI signals after you connect HDMI cable with the monitor.

6.  Power button/power indicator
- Turns the monitor on/off.
 - The color definition of the power indicator is as the below table.

Status	Description
Blue	ON
Amber	Standby mode
OFF	OFF

1.4.2 Back view

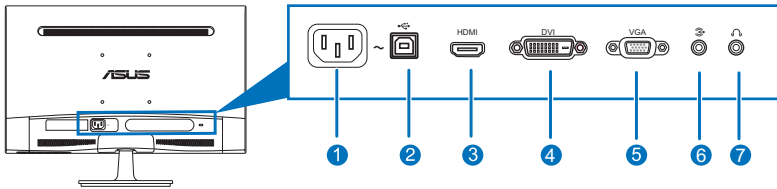

Rear connectors

1. **AC-IN port.** This port connects the power cord.
2. **USB upstream port.** This port is for connection with a USB upstream cable. The cable enables the built-in webcam on the monitor.
3. **HDMI port.** This port is for connection with an HDMI compatible device.
4. **DVI port.** This 24-pin port is for PC (Personal Computer) DVI-D digital signal connection.
5. **VGA port.** This 15-pin port is for PC VGA connection.
6. **Audio-in port.** This port connects PC audio source by the bundled audio cable.
7. **Earphone jack.** This port is only available when an HDMI cable is connected.

1.4.3 QuickFit Function (VK228H/VK228S/VK228T)

The QuickFit function allows users have a preview of the document or photo layout directly on screen without printing test copies.

To activate QuickFit, press the QuickFit hotkey, and then press the MENU key to switch between different pattern sizes.

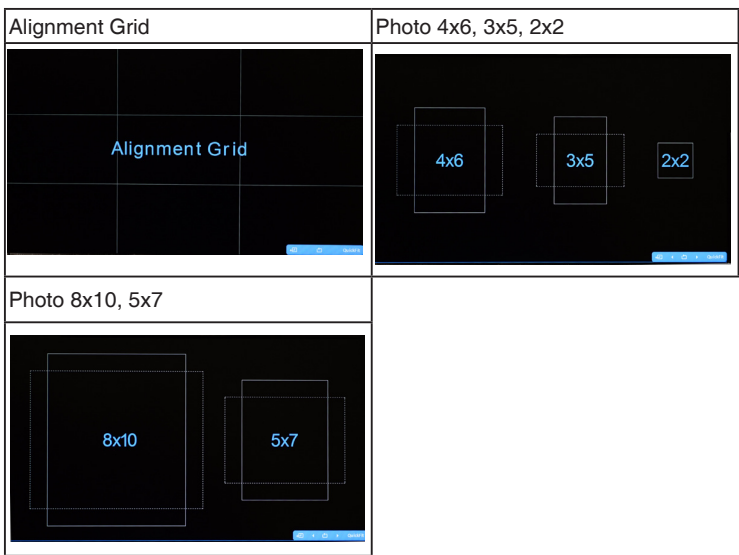

When QuickFit is activated, press the control buttons on the front panel to make adjustments. The QuickFit OSD displayed in the lower right corner of the screen will guide users to make selections.



The QuickFit OSD shown on the screen is not accessible by tapping on it.

2.1 Assembling the monitor arm/base

To assemble the monitor base:

1. Have the front of the monitor face down on a table.
2. Attach the base into the arm, making sure the tab on the arm fits into the groove on the base.
3. Fix the base to the arm by fastening the bundled screw.



We recommend that you cover the table surface with soft cloth to prevent damage to the monitor.

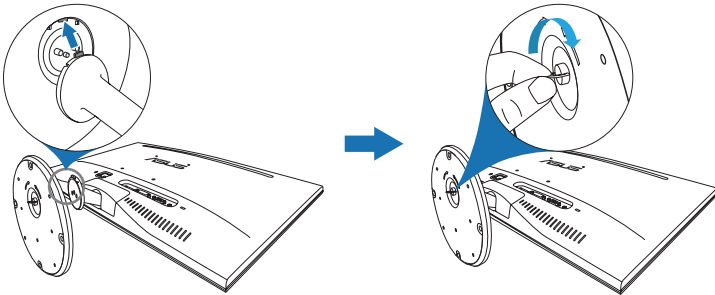

2.2 Adjusting the monitor

- For optimal viewing, we recommend that you look at the full face of the monitor, then adjust the monitor to the angle that is most comfortable for you.
- Hold the stand to prevent the monitor from falling when you change its angle.
- The recommended adjusting angle is $+20^{\circ}$ to -5° .

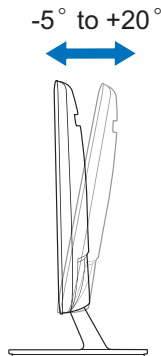

It is normal that the monitor slightly shakes while you adjust the viewing angle.

2.3 Detaching the arm/base (for VESA wall mount)

The detachable arm/base of this monitor is specially designed for VESA wall mount.

To detach the arm/base:

1. Have the front of the monitor face down on a table.
2. Remove the rubbers in the four screw holes. (Figure 1)
3. Remove the base (Figure 2).
4. Pry the rear hinge cover (Figure 3).
5. Use a screwdriver to remove the four screws on the hinge (Figure 4), then remove the hinge.

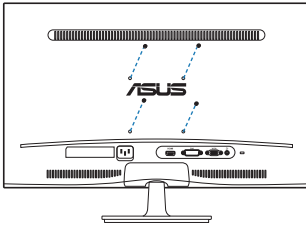

Figure 1

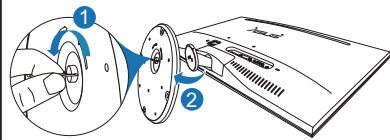

Figure 2

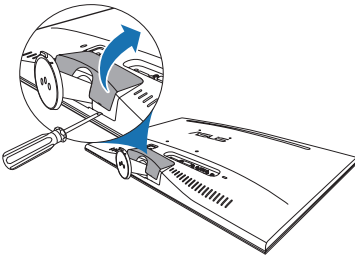

Figure 3

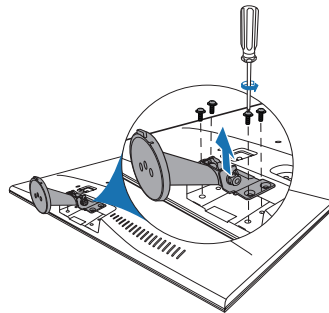

Figure 4



We recommend that you cover the table surface with soft cloth to prevent damage to the monitor.

2.4 Connecting the cables

Connect the cables as the following instructions:

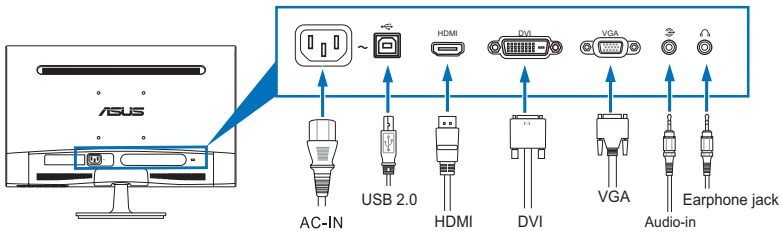



- **To connect the audio cable:** connect one end of the audio cable to the monitor's Audio-in port, the other end to the computer's audio-out port.
- **To connect the power cord:** connect one end of the power cord securely to the monitor's AC input, the other end to a power outlet.
- **To connect the VGA/DVI/HDMI cable:**
 - a. Plug one end of the VGA/DVI/HDMI cable to the monitor's VGA/DVI/HDMI port.
 - b. Connect the other end of the VGA/DVI/HDMI cable to your computer's VGA/DVI/HDMI port.
 - c. Tighten the two screws to secure the VGA/DVI connector.
- **To use the webcam:** connect the upstream port of the monitor and the USB port of your computer with the supplied USB cable.
- **To use the earphone (only when an HDMI cable is connected):** connect the end with plug type to the monitor's earphone jack.



When these cables are connected, you can choose the desired signal from the Input Select item in the OSD menu.

2.5 Turning on the monitor

Press the power button . See page 1-2 for the location of the power button. The power indicator  lights up in blue to show that the monitor is ON.

3.1 OSD (On-Screen Display) menu

3.1.1 How to reconfigure

1. Press the MENU button to activate the OSD menu.
2. Press / or / , and / to navigate through the functions. Highlight the desired function and press the MENU button to activate it. If the function selected has a sub-menu, press / or / , and / again to navigate through the sub-menu functions. Highlight the desired sub-menu function and press the MENU button to activate it.
3. Press / or / , and / to change the settings of the selected function.
4. To exit and save the OSD menu, press the / button repeatedly until the OSD menu disappears. To adjust other functions, repeat steps 1-3.

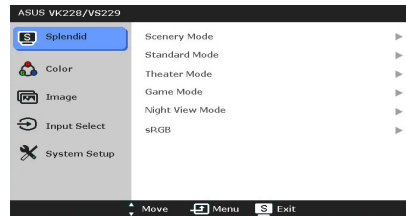

3.1.2 OSD function introduction

1. Splendid

This function contains six sub-functions you can select for your preference. Each mode has the Reset selection allowing you to maintain your setting or return to the preset mode.

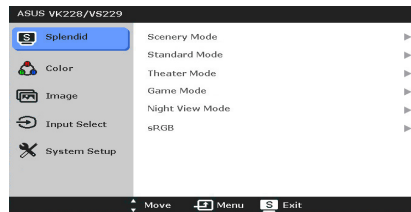



- **Scenery Mode:** best choice for scenery photo display with SPLENDID™ Video Enhancement.
- **Standard Mode:** best choice for document editing with SPLENDID™ Video Enhancement.
- **Theater Mode:** best choice for movies with SPLENDID™ Video Enhancement.
- **Game Mode:** best choice for games playing with SPLENDID™ Video Enhancement.
- **Night View Mode:** best choice for dark-scene games or movies with SPLENDID™ Video Enhancement.
- **sRGB:** best choice for viewing photos and graphics from PCs.



In the Standard Mode, the ASCR, Saturation and Sharpness functions are not user-configurable.

2. Color

You can adjust Brightness, Contrast, Saturation, Color Temp., and Skin Tone from this menu.

- **Brightness:** the adjusting range is from 0 to 100.  /  is a hotkey to activate this function.
- **Contrast:** the adjusting range is from 0 to 100.
- **Saturation:** the adjusting range is from 0 to 100.
- **Color Temp.:** contains four modes including Cool, Normal, Warm, and User Mode.
- **Skin Tone:** contains three color modes including Reddish, Natural, and Yellowish.
- **Smart View:** provides better display quality under big viewing angle.

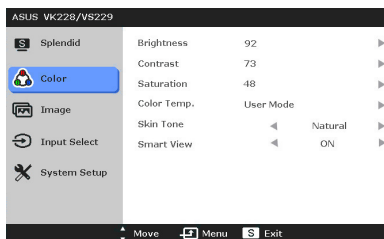

In the User mode, colors of R (Red), G (Green), and B (Blue) are user-configurable; the adjusting range is from 0-100.

3. Image

You can adjust Sharpness, Trace Free, Aspect Control, ASCR, Position (VGA only), and Focus (VGA only) from this menu.

- **Sharpness:** the adjusting range is from 0 to 100.
- **Trace Free:** adjusts the response time of the monitor.
- **Aspect Control:** adjusts the aspect ratio to full, 4:3, 1:1 or OverScan.

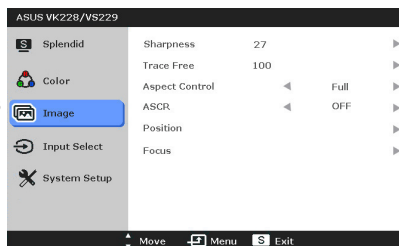

4:3 is only available when input source is in 4:3 format. OverScan is only available for the HDMI input source.

- **ASCR:** turns on/off the ASCR (ASUS Smart Contrast Ratio) function.
- **Position:** adjusts the horizontal position (H-Position) and the vertical position (V-Position) of the image. The adjusting range is from 0 to 100.
- **Focus:** reduces Horizontal-line noise and Vertical-line noise of the image by adjusting (Phase) and (Clock) separately. The adjusting range is from 0 to 100.



- Phase adjusts the phase of the pixel clock signal. With a wrong phase adjustment, the screen shows horizontal disturbances.
- Clock (pixel frequency) controls the number of pixels scanned by one horizontal sweep. If the frequency is not correct, the screen shows vertical stripes and the image is not proportional.

4. Input Select

In this function, you can select your desired input source.

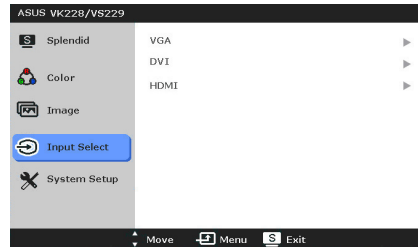

5. System Setup

Allows you to adjust the system.

- **Splendid Demo Mode:** splits the screen into two for Splendid modes comparison.
- **Volume:** the adjusting range is from 0 to 100.
- **ECO Mode:** reduces power consumption.
- **OSD Setup:**
 - * Adjusts the horizontal position (H-Position)/the vertical position (V-Position) of the OSD from 0 to 100.
 - * Adjusts the OSD timeout from 10 to 120 seconds.
 - * Enables or disables the DDC/CI function.
 - * Adjusts the OSD background from opaque to transparent.
- **Information:** shows the monitor information.
- **Language:** there are 10 languages for your selection, including English, German, Italian, French, Dutch, Spanish, Russian, Traditional Chinese, Simplified Chinese, and Japanese.
- **All Reset:** “Yes” allows you to restore the default settings.

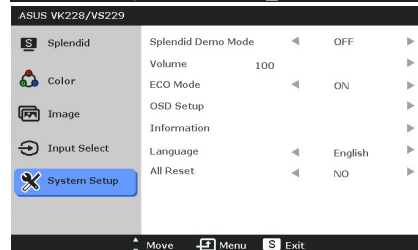

3.2 Specifications summary (VK228H)

Panel Type	TFT LCD
Panel size	21.5"W (16:9, 54.6 cm) wide screen
Max. Resolution	1920 x 1080
Pixel pitch	0.248 mm
Brightness (Typ.)	250 cd/m ²
Contrast Ratio (Typ.)	1000:1
Contrast Ratio (Max.)	50,000,000:1 (with ASCR on)
Viewing angle(H/V) CR>10	170°/160°
Display colors	16.7 M
Response time	5 ms
SPLENDID™ Video Enhancement	Yes
SPLENDID™ selection	6 video preset modes (by hotkey)
Auto adjustment	Yes (by hotkey)
Color temperature selection	4 color temperatures
Skin-Tone selection	3 skin-tones
Digital input	DVI-D with HDCP, HDMI v1.3
Analog input	D-Sub
Audio-in port	3.5 mm Mini-jack
Earphone jack	Yes (only for HDMI)
Colors	Black
Speaker (Built-in)	1 W x 2 Stereo, RMS
Power LED	Blue (On)/Amber (Standby)
Tilt	+20° ~ -5°
VESA wall mount	100 x 100 mm
Kensington lock	Yes
Voltage rating	AC: 100~240V
Power consumption	Power On: < 30 W, Standby: < 0.5 W, Power Off: < 0.5 W
Temperature (Operating)	0°C~40°C
Temperature (Non-operating)	-20°C~+60°C
Dimensions (W x H x D)	514.1 mm x 387.2 mm x 200.6 mm (machine) 566 mm x 443 mm x 130 mm (package)
Weight (Esti.)	3.220 kg (Net); 5.225 kg (Gross)
Multi-languages	10 languages (English, German, Italian, French, Dutch, Spanish, Russian, Traditional Chinese, Simplified Chinese, Japanese)
Accessories	VGA cable, DVI cable, USB cable, audio cable, power cord, Quick start guide, warranty card, LifeFrame 2 CD
Regulation approvals	Energy Star® (VK228H-CSM), CB, CE, Gost-R, CCC, UL/cUL, FCC, C-Tick, BSMI, VCCI, RoHS, WEEE, J-MOSS, ErP, Windows 7 WHQL

***Specifications are subject to change without notice.**

Specifications summary (VK228T)

Panel Type	TFT LCD
Panel size	21.5"W (16:9, 54.6 cm) wide screen
Max. Resolution	1920 x 1080
Pixel pitch	0.248 mm
Brightness (Typ.)	250 cd/m ²
Contrast Ratio (Typ.)	1000:1
Contrast Ratio (Max.)	50,000,000:1 (with ASCR on)
Viewing angle(H/V) CR>10	170°/160°
Display colors	16.7 M
Response time	5 ms
SPLENDID™ Video Enhancement	Yes
SPLENDID™ selection	6 video preset modes (by hotkey)
Auto adjustment	Yes (by hotkey)
Color temperature selection	4 color temperatures
Skin-Tone selection	3 skin-tones
Digital input	DVI-D with HDCP
Analog input	D-Sub
Audio-in port	3.5 mm Mini-jack
Colors	Black
Speaker (Built-in)	1 W x 2 Stereo, RMS
Power LED	Blue (On)/Amber (Standby)
Tilt	+20° ~ -5°
VESA wall mount	100 x 100 mm
Kensington lock	Yes
Voltage rating	AC: 100~240V
Power consumption	Power On: < 30 W, Standby: < 0.5 W, Power Off: < 0.5 W
Temperature (Operating)	0°C~40°C
Temperature (Non-operating)	-20°C~+60°C
Dimensions (W x H x D)	514.1 mm x 387.2 mm x 200.6mm (machine) 566 mm x 443 mm x 130 mm (package)
Weight (Esti.)	3.220 kg (Net); 5.225 kg (Gross)
Multi-languages	10 languages (English, German, Italian, French, Dutch, Spanish, Russian, Traditional Chinese, Simplified Chinese, Japanese)
Accessories	VGA cable, DVI cable, USB cable, audio cable, power cord, Quick start guide, warranty card, LifeFrame 2 CD
Regulation approvals	Energy Star®, CB, CE, Gost-R, CCC, UL/cUL, FCC, C-Tick, BSMI, VCCI, RoHS, WEEE, J-MOSS, ErP, Windows 7 WHQL

***Specifications are subject to change without notice.**

Specifications summary (VK228S)

Panel Type	TFT LCD
Panel size	21.5"W (16:9, 54.6 cm) wide screen
Max. Resolution	1920 x 1080
Pixel pitch	0.248 mm
Brightness (Typ.)	250 cd/m ²
Contrast Ratio (Typ.)	1000:1
Contrast Ratio (Max.)	50,000,000:1 (with ASCR on)
Viewing angle(H/V) CR>10	170°/160°
Display colors	16.7 M
Response time	5 ms
SPLENDID™ Video Enhancement	Yes
SPLENDID™ selection	6 video preset modes (by hotkey)
Auto adjustment	Yes (by hotkey)
Color temperature selection	4 color temperatures
Skin-Tone selection	3 skin-tones
Analog input	D-Sub
Audio-in port	3.5 mm Mini-jack
Colors	Black
Speaker (Built-in)	1 W x 2 Stereo, RMS
Power LED	Blue (On)/Amber (Standby)
Tilt	+20° ~ -5°
VESA wall mount	100 x 100 mm
Kensington lock	Yes
Voltage rating	AC: 100~240V
Power consumption	Power On: < 30 W, Standby: < 0.5 W, Power Off: < 0.5 W
Temperature (Operating)	0°C~40°C
Temperature (Non-operating)	-20°C~+60°C
Dimensions (W x H x D)	514.1 mm x 387.2 mm x 200.6 mm (machine) 566 mm x 443 mm x 130 mm (package)
Weight (Esti.)	3.220 kg (Net); 5.225 kg (Gross)
Multi-languages	10 languages (English, German, Italian, French, Dutch, Spanish, Russian, Traditional Chinese, Simplified Chinese, Japanese)
Accessories	VGA cable, USB cable, audio cable, power cord, Quick start guide, warranty card, LifeFrame 2 CD
Regulation approvals	Energy Star®, CB, CE, Gost-R, CCC, UL/cUL, FCC, C-Tick, BSMI, VCCI, RoHS, WEEE, J-MOSS, ErP, Windows 7 WHQL





*Specifications are subject to change without notice.

Specifications summary (VS229)

Panel Type	TFT LCD
Panel size	21.5"W (16:9, 54.6 cm) wide screen
Max. Resolution	1920 x 1080
Pixel pitch	0.248 mm
Brightness (Typ.)	250 cd/m ²
Contrast Ratio (Typ.)	3000:1
Contrast Ratio (Max.)	80,000,000:1 (with ASCR on)
Viewing angle(H/V) CR>10	178°/178°
Display colors	16.7 M
Response time	5 ms (Gray to gray)
SPLENDID™ Video Enhancement	Yes
SPLENDID™ selection	6 video preset modes (by hotkey)
Auto adjustment	Yes (by hotkey)
Color temperature selection	4 color temperatures
Skin-Tone selection	3 skin-tones
Digital input	HDMI v1.4, DVI
Analog input	D-Sub
Audio-in port	3.5 mm Mini-jack
Earphone jack	Yes
Colors	Black
Speaker (Built-in)	No
Power LED	Blue (On)/Amber (Standby)
Tilt	+20° ~ -5°
VESA wall mount	100 x 100 mm
Kensington lock	Yes
Voltage rating	AC: 100~240V
Power consumption	Power On: < 21.09 W, Standby: < 0.5 W, Power Off: < 0.5 W
Temperature (Operating)	0°C~40°C
Temperature (Non-operating)	-20°C~+60°C
Dimensions (W x H x D)	514.1 mm x 387.2 mm x 200.6 mm (machine) 566 mm x 443 mm x 130 mm (package)
Weight (Esti.)	3.5 kg (Net); 5.4 kg (Gross)
Multi-languages	10 languages (English, German, Italian, French, Dutch, Spanish, Russian, Traditional Chinese, Simplified Chinese, Japanese)
Accessories	VGA cable, DVI cable, power cord, Quick start guide, warranty card
Regulation approvals	CB, CE, CU, CCC, CEL(Level1), UL/cUL, FCC, C-Tick, BSMI, VCCI, PSB, RoHS, WEEE, J-MOSS, ErP, TCO 7.0, Ukraine, Windows 7/8 WHQL

***Specifications are subject to change without notice.**

3.3 Troubleshooting (FAQ)

Problem	Possible Solution
Power LED is not ON	<ul style="list-style-type: none"> • Press the  button to check if the monitor is in the ON mode. • Check if the power cord is properly connected to the monitor and the power outlet.
The power LED lights amber and there is no screen image	<ul style="list-style-type: none"> • Check if the monitor and the computer are in the ON mode. • Make sure the signal cable is properly connected the monitor and the computer. • Inspect the signal cable and make sure none of the pins are bent. • Connect the computer with another available monitor to check if the computer is properly working.
Screen image is too light or dark	<ul style="list-style-type: none"> • Adjust the Contrast and Brightness settings via OSD.
Screen image is not centered or sized properly	<ul style="list-style-type: none"> • Press the  /  button for 2-4 seconds to automatically adjust the image (for VGA mode only). • Adjust the H-Position or V-Position settings via OSD.
Screen image bounces or a wave pattern is present in the image	<ul style="list-style-type: none"> • Make sure the signal cable is properly connected to the monitor and the computer. • Move electrical devices that may cause electrical interference.
Screen image has color defects (white does not look white)	<ul style="list-style-type: none"> • Inspect the signal cable and make sure that none of the pins are bent. • Perform All Reset via OSD. • Adjust the R/G/B color settings or select the Color Temperature via OSD.
Screen image is blurry or fuzzy	<ul style="list-style-type: none"> • Press the  /  button for 2-4 seconds to automatically adjust the image (for VGA mode only). • Adjust the Phase and Clock settings via OSD.
No sound or sound is low	<ul style="list-style-type: none"> • Ensure that the HDMI cable is properly connected to the monitor and the computer. • Adjust the volume settings of both your monitor and HDMI device. • Ensure that the computer sound card driver is properly installed and activated.

3.4 Supported operating modes

Resolution Frequency	Horizontal Frequency (KHz)	Vertical Frequency (Hz)	Pixel (MHz)
640x480	31.5	60	25.18
640x480	35.0	67	30.24
640x480	37.9	72	31.50
640x480	37.5	75	31.50
720x400	31.5	70	28.32
800x600	35.16	56	36.00
800x600	37.9	60	40.00
800x600	48.1	72	66.75
800x600	46.9	75	49.50
832x624	49.7	75	57.28
1024x768	48.4	60	65.00
1024x768	56.5	70	75.00
1024x768	60.0	75	78.50
1152x864	67.5	75	108.00
1280x720	45	60	75.25
1280x768	47.78	60	79.50
1280x800	49.7	60	83.50
1280x960	60.0	60	108.00
1280x1024	63.4	60	108.00
1280x1024	79.97	75	135.00
1360x768	47.71	60	85.50
1366x768	47.71	60	85.50
1440x900	55.94	60	106.50
1600x1200	75.0	60	162.00
1680x1050	65.3	60	146.25
1920x1080 (Primary)	67.5	60	148.50

* Modes not listed in the table may not be supported. For optimal resolution, we recommend that you choose a mode listed in the table above.

* This monitor supports full HD (480p, 576p, 720p, 1080i/p) video content from game consoles, DVD players and other consumer video devices via HDMI.

Free Manuals Download Website

<http://myh66.com>

<http://usermanuals.us>

<http://www.somanuals.com>

<http://www.4manuals.cc>

<http://www.manual-lib.com>

<http://www.404manual.com>

<http://www.luxmanual.com>

<http://aubethermostatmanual.com>

Golf course search by state

<http://golfingnear.com>

Email search by domain

<http://emailbydomain.com>

Auto manuals search

<http://auto.somanuals.com>

TV manuals search

<http://tv.somanuals.com>