

User Manual

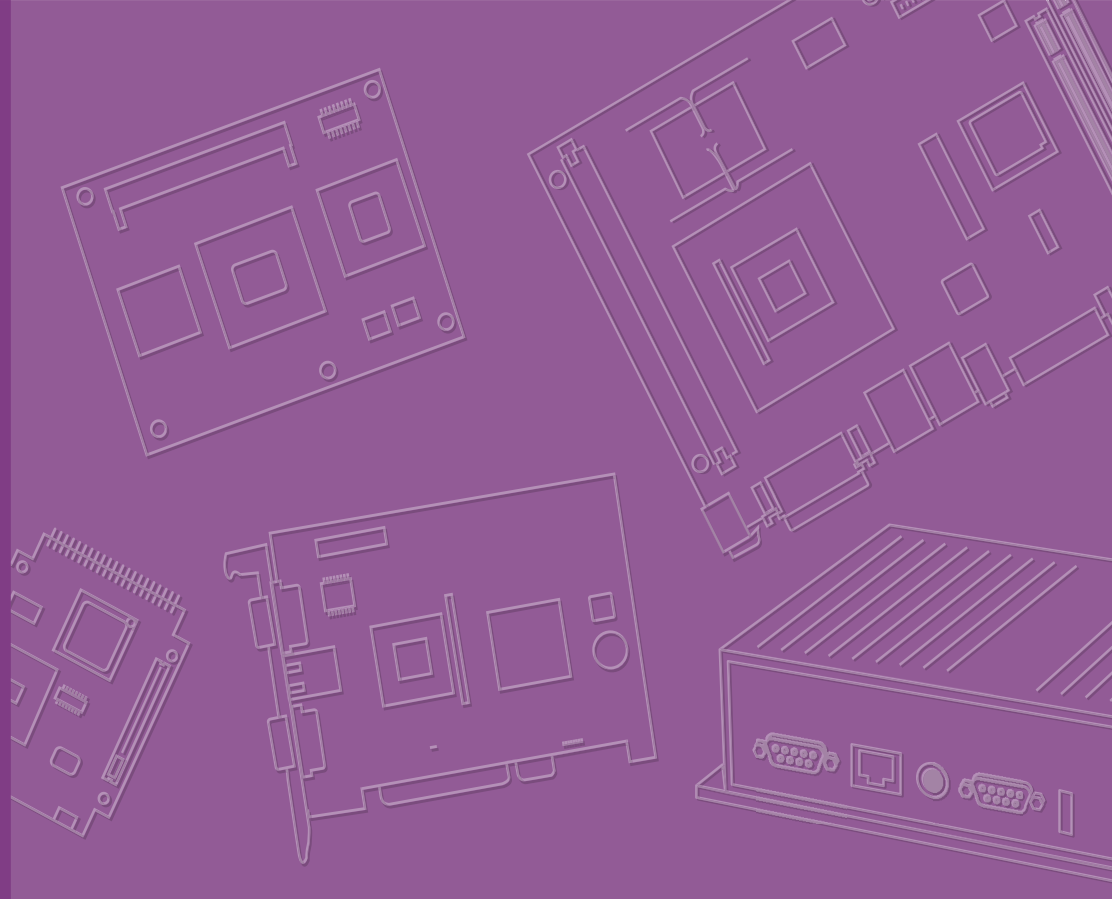

MIOe-DB5000

MIOe Evaluation Board for MIO-Compact and MIO-Ultra SBC

ADVANTECH

Enabling an Intelligent Planet

Copyright

The documentation and the software included with this product are copyrighted 2012 by Advantech Co., Ltd. All rights are reserved. Advantech Co., Ltd. reserves the right to make improvements in the products described in this manual at any time without notice. No part of this manual may be reproduced, copied, translated or transmitted in any form or by any means without the prior written permission of Advantech Co., Ltd. Information provided in this manual is intended to be accurate and reliable. However, Advantech Co., Ltd. assumes no responsibility for its use, nor for any infringements of the rights of third parties, which may result from its use.

Acknowledgements

Intel® is a trademark of Intel® Technologies, Inc.

IBM, PC/AT, PS/2 and VGA are trademarks of International Business Machines Corporation.

Microsoft Windows® is a registered trademark of Microsoft Corp.

All other product names or trademarks are properties of their respective owners.

Product Warranty (2 years)

Advantech warrants to you, the original purchaser, that each of its products will be free from defects in materials and workmanship for two years from the date of purchase.

This warranty does not apply to any products which have been repaired or altered by persons other than repair personnel authorized by Advantech, or which have been subject to misuse, abuse, accident or improper installation. Advantech assumes no liability under the terms of this warranty as a consequence of such events.

Because of Advantech's high quality-control standards and rigorous testing, most of our customers never need to use our repair service. If an Advantech product is defective, it will be repaired or replaced at no charge during the warranty period. For out-of-warranty repairs, you will be billed according to the cost of replacement materials, service time and freight. Please consult your dealer for more details.

If you think you have a defective product, follow these steps:

1. Collect all the information about the problem encountered. (For example, CPU speed, Advantech products used, other hardware and software used, etc.) Note anything abnormal and list any onscreen messages you get when the problem occurs.
2. Call your dealer and describe the problem. Please have your manual, product, and any helpful information readily available.
3. If your product is diagnosed as defective, obtain an RMA (return merchandise authorization) number from your dealer. This allows us to process your return more quickly.
4. Carefully pack the defective product, a fully-completed Repair and Replacement Order Card and a photocopy proof of purchase date (such as your sales receipt) in a shippable container. A product returned without proof of the purchase date is not eligible for warranty service.
5. Write the RMA number visibly on the outside of the package and ship it prepaid to your dealer.

Declaration of Conformity

CE

This product has passed the CE test for environmental specifications. Test conditions for passing included the equipment being operated within an industrial enclosure. In order to protect the product from being damaged by ESD (Electrostatic Discharge) and EMI leakage, we strongly recommend the use of CE-compliant industrial enclosure products.

FCC Class A

This equipment has been tested and found to comply with the limits for a Class A digital device, pursuant to Part 15 of the FCC Rules. These limits are designed to provide reasonable protection against harmful interference when the equipment is operated in a commercial environment. This equipment generates, uses, and can radiate radio frequency energy and, if not installed and used in accordance with the instruction manual, may cause harmful interference to radio communications. Operation of this device in a residential area is likely to cause harmful interference in which case the user will be required to correct the interference at his/her own expense. The user is advised that any equipment changes or modifications not expressly approved by the party responsible for compliance would void the compliance to FCC regulations and therefore, the user's authority to operate the equipment.

Caution! *There is a danger of a new battery exploding if it is incorrectly installed. Do not attempt to recharge, force open, or heat the battery. Replace the battery only with the same or equivalent type recommended by the manufacturer. Discard used batteries according to the manufacturer's instructions.*



Technical Support and Assistance

1. Visit the Advantech website at <http://support.advantech.com> where you can find the latest information about the product.
2. Contact your distributor, sales representative, or Advantech's customer service center for technical support if you need additional assistance. Please have the following information ready before you call:
 - Product name and serial number
 - Description of your peripheral attachments
 - Description of your software (operating system, version, application software, etc.)
 - A complete description of the problem
 - The exact wording of any error messages

Packing List

Before you begin installing your card, please make sure that the following materials have been shipped:

- 1 MIOe-DB5000 development board
- 2 x Reset/Power button cables (P/N: 1700020235-01)

If any of these items are missing or damaged, contact your distributor or sales representative immediately.

Ordering Information

Part No.	DisplayPort	PCIe x1	MIOe	Full-size Mini PCIe	SIM holder	SATA II	LPC	SMBus	USB 2.0	USB 3.0	Audio	System Fan	Power Conn
MIOe-DB5000-00A1E	1*	3	1	1	1	1	1	1	1	1***	1	1	2x2
MIOe-DB5000-01A1E	1*	2**	1	1**	1	1	1	1	1	1***	1	1	2x2

* The DisplayPort Riser Card has both HDMI and DisplayPort. Each can be supported individually by signal setting on the MI/O main board.

** MIOe-DB5000-01A1E has 2 PCIe x1 and 1 Mini PCIe.

*** For USB 3.0 to work depends on if the MI/O mainboard supports USB 3.0 or not. If the bundled MI/O main board doesn't support USB 3.0 explicitly, the USB connector supports USB 2.0 only.

Optional Accessories

Part Number	Description
9696EA2000E	DisplayPort Riser Card*
PCA-COM232-00A1E	4 ports RS-232 Module**
PCA-COM485-00A1E	4 ports RS-422/485 Module**

* Only support Port B because there is only one DP channel from MIOe to Riser card, default support HDMI port; DP port supported by request.

** Support by request

Safety Instructions

1. Read these safety instructions carefully.
2. Keep this User Manual for later reference.
3. Disconnect this equipment from any AC outlet before cleaning. Use a damp cloth. Do not use liquid or spray detergents for cleaning.
4. For plug-in equipment, the power outlet socket must be located near the equipment and must be easily accessible.
5. Keep this equipment away from humidity.
6. Put this equipment on a reliable surface during installation. Dropping it or letting it fall may cause damage.
7. The openings on the enclosure are for air convection. Protect the equipment from overheating. **DO NOT COVER THE OPENINGS.**
8. Make sure the voltage of the power source is correct before connecting the equipment to the power outlet.
9. Position the power cord so that people cannot step on it. Do not place anything over the power cord.
10. All cautions and warnings on the equipment should be noted.
11. If the equipment is not used for a long time, disconnect it from the power source to avoid damage by transient overvoltage.
12. Never pour any liquid into an opening. This may cause fire or electrical shock.
13. Never open the equipment. For safety reasons, the equipment should be opened only by qualified service personnel.
14. If one of the following situations arises, get the equipment checked by service personnel:
 - The power cord or plug is damaged.
 - Liquid has penetrated into the equipment.
 - The equipment has been exposed to moisture.
 - The equipment does not work well, or you cannot get it to work according to the user's manual.
 - The equipment has been dropped and damaged.
 - The equipment has obvious signs of breakage.
15. **DO NOT LEAVE THIS EQUIPMENT IN AN ENVIRONMENT WHERE THE STORAGE TEMPERATURE MAY GO BELOW -20° C (-4° F) OR ABOVE 60° C (140° F). THIS COULD DAMAGE THE EQUIPMENT. THE EQUIPMENT SHOULD BE IN A CONTROLLED ENVIRONMENT.**
16. **CAUTION: DANGER OF EXPLOSION IF BATTERY IS INCORRECTLY REPLACED. REPLACE ONLY WITH THE SAME OR EQUIVALENT TYPE RECOMMENDED BY THE MANUFACTURER, DISCARD USED BATTERIES ACCORDING TO THE MANUFACTURER'S INSTRUCTIONS.**

The sound pressure level at the operator's position according to IEC 704-1:1982 is no more than 70 dB (A).

DISCLAIMER: This set of instructions is given according to IEC 704-1. Advantech disclaims all responsibility for the accuracy of any statements contained herein.

Contents

Chapter 1 Connector, Jumper and Switch Settings...1

1.1	Introduction	2
1.2	Block Diagram.....	2
	Figure 1.1 Block Diagram	2
1.3	Placement	3
1.4	Jumpers	3
	1.4.1 Jumper Description	3
	1.4.2 Jumper Table	4
	Table 1.1: Jumper Table.....	4
1.5	Connector Table.....	4
	Table 1.2: Connector Table	4
1.6	Switch Table.....	5
	Table 1.3: Switch Table	5
1.7	Jumper, Connector and Switch Pin Definition	5

Chapter 1

Connector, Jumper and Switch Setting

This chapter gives you the general introduction to MIOe-DB5000 and instructions on jumper settings, connectors information as well as switch installation on the MIOe-DB5000 evaluation board.

Sections include:

- General Introduction
- Block Diagram
- Connector, Jumper and Switch table
- Connector, Jumper and Switch Pin Definitions

1.1 Introduction

MIOe-DB5000 is MIOe evaluation board for MI/O-Compact and MI/O-Ultra SBC with standard ATX form factor. It's compatible with MIOe, all circuit designs follow MI/O Extension design guide. MIOe-DB5000 have flexible interfaces for verification and various applications, including 1 display port, 3 PCIe, 1 mini PCIe, 1 SIM card holder, 1 USB 3.0, 1 USB 2.0, 1 LPC (Low Pin Count), 1 SMBus, 1 line out with amplifier, 1 SATA with power, 2 system FAN, and 1 +12V DC in.

1.2 Block Diagram

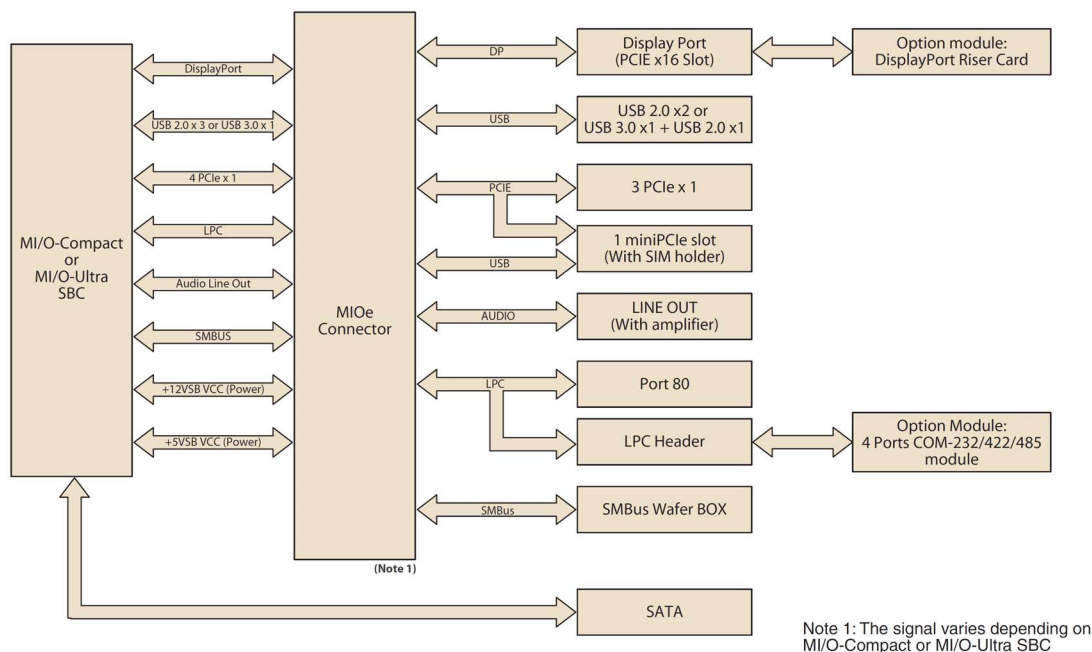
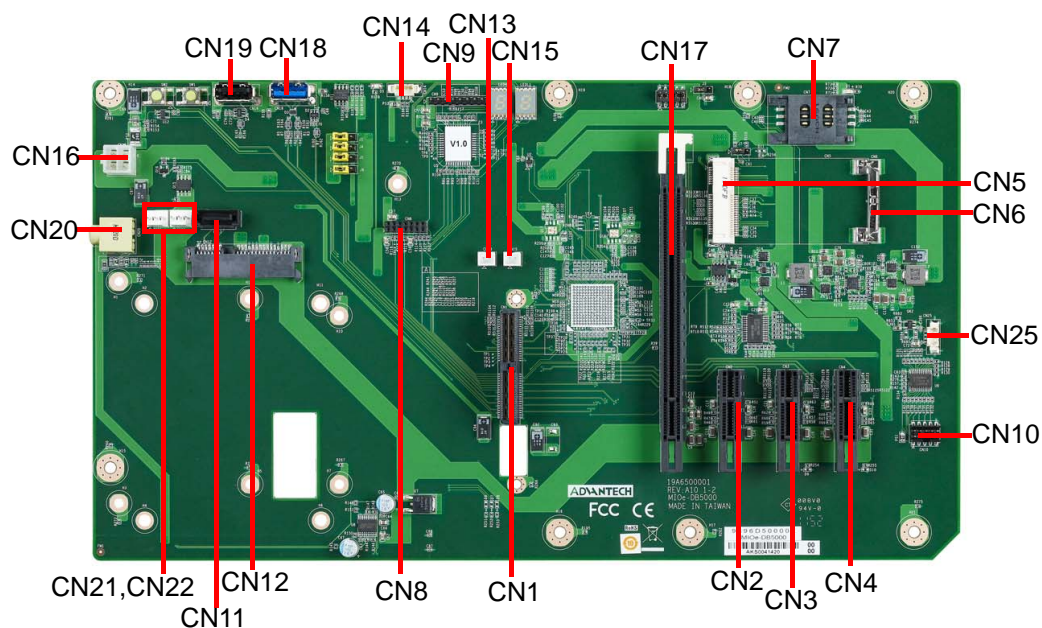

Figure 1.1 Block Diagram

1.3 Placement



1.4 Jumpers

1.4.1 Jumper Description

Cards can be configured by setting jumpers. A jumper is a metal bridge used to close an electric circuit. It consists of two metal pins and a small metal clip (often protected by a plastic cover) that slides over the pins to connect them. To close a jumper, you connect the pins with the clip. To open a jumper, you remove the clip. Sometimes a jumper will have three pins, labeled 1, 2 and 3. In this case you would connect either pins 1 and 2, or 2 and 3.

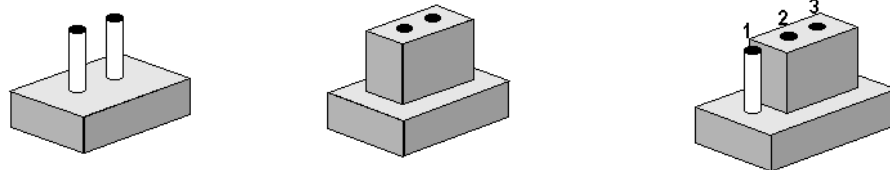

The jumper settings are schematically depicted in this manual as follows.



A pair of needle-nose pliers may be helpful when working with jumpers. If you have any doubts about the best hardware configuration for your application, contact your local distributor or sales representative before you make any changes.

Generally, you simply need a standard cable to make most connections.

Warning! To avoid damaging the computer, always turn off the power supply before setting jumpers.



1.4.2 Jumper Table

Table 1.1: Jumper Table

Jumper	Descriptions	Setting	Function
J1, J4, J5, J6	Power Setting	(1, 2)*	External 12V Power
		(2, 3)	MIOe 12V Power
J2	Mini PCIe	(1-2), (3-4), (7-8), (9-10)*	Mini PCIE V1.2
		All open	Mini PCIE V1.1
J3	Mini PCIe	(1, 2)*	Mini PCIE V1.2
		(2, 3)	Mini PCIE V1.1

* Default

1.5 Connector Table

Table 1.2: Connector Table

Connector	Description
CN1	MIOe
CN2	PCIEx1 Slot (only MIOe-DB5000-00A1E)
CN3	PCIEx1 Slot
CN4	PCIEx1 Slot
CN5	Mini PCIE
CN6	Mini PCIE Holder
CN7	SIM Card
CN8	LPC
CN9	CPLD
CN10	GPIO
CN11	SATA_7P
CN12	SATA_22P
CN13	Power Button
CN14	SMBus from MIOe
CN15	Reset Button
CN16	External 12V input power
CN17	DisplayPort or HDMI *
CN18	USB2.0 or USB3.0 *
CN19	USB2.0
CN20	Audio Line Out
CN21	Fan
CN22	Fan
CN25	SMBus from main board for test purpose

* Depends on MI/O main board

1.6 Switch Table

Table 1.3: Switch Table

SW	Description
SW1	Power
SW2	Reset

1.7 Jumper, Connector and Switch Pin Definition

J1, J4, J5, J6 PH_3x1V_2.54mm	
Part Number	1653003100
Footprint	HD_3x1P_100_D
Description	PIN HEADER 3x1P 2.54mm 180D(M) DIP 205-1x3GS
Setting	Function
1	+V12SB_EXT
2	+V12SB_DB5000
3	+V12SB_MIO

Default is (1,2)- External 12V Power

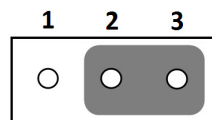
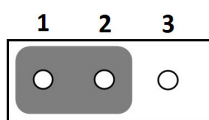

J2 PH_5x2V_S2.00mm

Part Number	1653005261
Footprint	HD_5x2P_79
Description	PIN HEADER 5x2P 2.0mm 180D(M) SMD 21N22050
Setting	Function
1	GND_PIN43
2	GND
3	GND_PIN37
4	GND
5	NC
6	NC
7	+V3.3SB_PIN41
8	+V3.3SB
9	+V3.3SB_PIN39
10	+V3.3SB

Default is (1-2), (3-4), (7-8), (9-10)- Mini PCIE V1.2

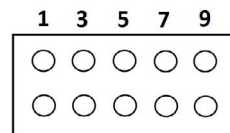
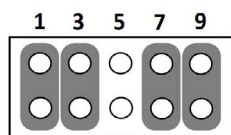

J3 PH_3x1V_2.00mm

Part Number	1653003101
Footprint	HD_3x1P_79_D
Description	PIN HEADER 3x1P 2.0mm 180D(M) DIP 2000-13 WS
Setting	Function
1	+V3.3SB
2	+V3.3_MINIPICIE
3	+V3.3

Default is (2,3)- Mini PCIE V1.2

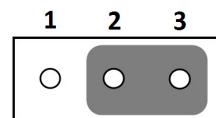
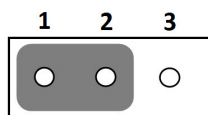

CN1 MIOe	
Part Number	1654004704
Footprint	BB_40x2P_32_3150x235
Description	
Pin	Pin Name
1	GND
2	GND
3	PCIE_RX0+
4	PCIE_TX0+
5	PCIE_RX0-
6	PCIE_TX0-
7	GND
8	GND
9	PCIE_RX1+
10	PCIE_TX1+
11	PCIE_RX1-
12	PCIE_TX1-
13	GND
14	GND
15	PCIE_RX2+
16	PCIE_TX2+
17	PCIE_RX2-
18	PCIE_TX2-
19	GND
20	GND
21	PCIE_RX3+
22	PCIE_TX3+
23	PCIE_RX3-
24	PCIE_TX3-
25	GND
26	GND
27	PCIE_CLK+
28	LOUTL
29	PCIE_CLK-
30	LOUTR
31	GND
32	AGND
33	SMB_CLK
34	NC
35	SMB_DAT
36	NC
37	PCIE_WAKE#
38	NC
39	RESET#
40	NC
41	SLP_S3#
42	CLK33M

43	NC
44	LPC_AD0
45	DDP_HPD
46	LPC_AD1
47	GND
48	LPC_AD2
49	DDP_AUX+
50	LPC_AD3
51	DDP_AUX-
52	LPC_DRQ#0
53	GND
54	LPC_SERIRQ
55	DDP_D0+
56	LPC_FRAME#
57	DDP_D0-
58	GND
59	GND
60	USB0_D+
61	DDP_D1+
62	USB0_D-
63	DDP_D1-
64	GND
65	GND
66	USB1_D+/USB_SSTX+
67	DDP_D2+
68	USB1_D-/USB_SSTX-
69	DDP_D2-
70	GND
71	GND
72	USB2_D+/USB_SSRX+
73	DDP_D3+
74	USB2_D-/USB_SSRX-
75	DDP_D3-
76	GND
77	GND
78	USB_OC#
79	+12VSB
80	+12VSB

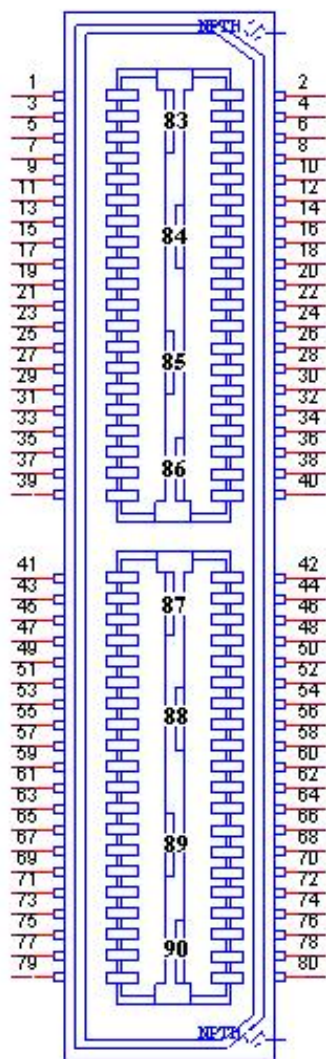

CN2 PCIe1 Slot	
Part Number	1654000394
Footprint	PCISLOT-1X-KORTAK
Description	
Pin	Pin Name
A1	NC
A2	+12V
A3	+12V
A4	GND
A5	JTAG2
A6	JTAG3
A7	NC
A8	JTAG5
A9	+3.3V
A10	+3.3V
A11	PWRGD
A12	GND
A13	REFCLK+
A14	REFCLK-
A15	GND
A16	HSIP0
A17	HSIN0
A18	GND
B1	+12V
B2	+12V
B3	+12V
B4	GND
B5	SMB_CLK
B6	SMB_DAT
B7	GND
B8	+3.3V
B9	JTAG1
B10	+3.3VSB
B11	PCIE_WAKE#
B12	NC
B13	GND
B14	HSOP0
B15	HSO0N0
B16	GND
B17	NC
B18	GND

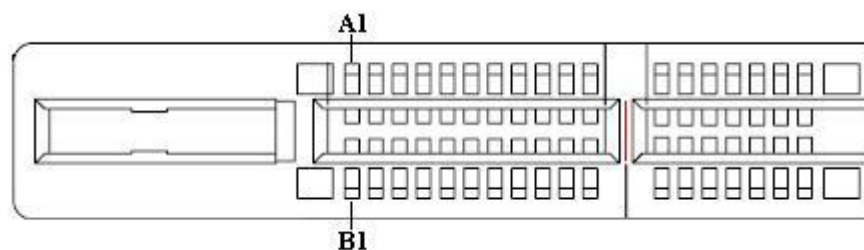

CN3 PCIe1 Slot	
Part Number	1654000394
Footprint	PCISLOT-1X-KORTAK
Description	
Pin	Pin Name
A1	NC
A2	+12V
A3	+12V
A4	GND
A5	JTAG2
A6	JTAG3
A7	NC
A8	JTAG5
A9	+3.3V
A10	+3.3V
A11	PWRGD
A12	GND
A13	REFCLK+
A14	REFCLK-
A15	GND
A16	HSIP0
A17	HSIN0
A18	GND
B1	+12V
B2	+12V
B3	+12V
B4	GND
B5	SMB_CLK
B6	SMB_DAT
B7	GND
B8	+3.3V
B9	JTAG1
B10	+3.3VSB
B11	PCIE_WAKE#
B12	NC
B13	GND
B14	HSOP0
B15	HSOP0
B16	GND
B17	NC
B18	GND

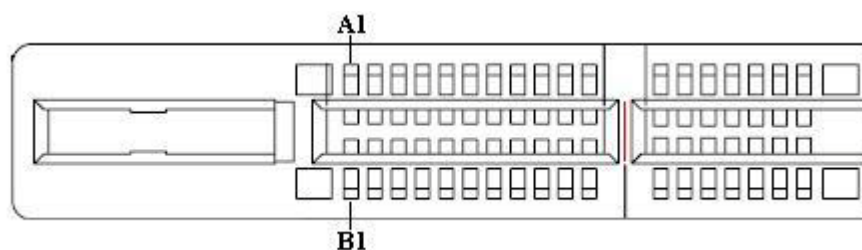

CN4	PCIEx1 Slot
Part Number	1654000394
Footprint	PCISLOT-1X-KORTAK
Description	
Pin	Pin Name
A1	NC
A2	+12V
A3	+12V
A4	GND
A5	JTAG2
A6	JTAG3
A7	NC
A8	JTAG5
A9	+3.3V
A10	+3.3V
A11	PWRGD
A12	GND
A13	REFCLK+
A14	REFCLK-
A15	GND
A16	HSIP0
A17	HSIN0
A18	GND
B1	+12V
B2	+12V
B3	+12V
B4	GND
B5	SMB_CLK
B6	SMB_DAT
B7	GND
B8	+3.3V
B9	JTAG1
B10	+3.3VSB
B11	PCIE_WAKE#
B12	NC
B13	GND
B14	HSOP0
B15	HSO0N0
B16	GND
B17	NC
B18	GND

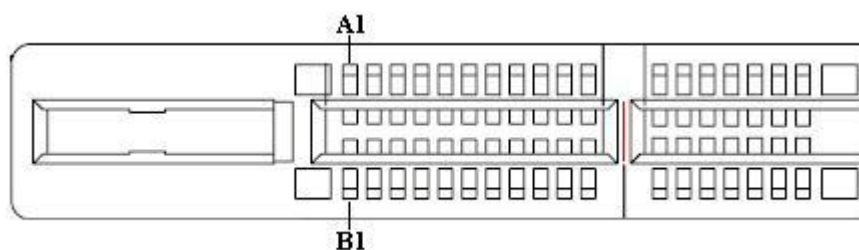

CN5 Mini PCIE	
Part Number	1654002538
Footprint	FOX_AS0B226-S68K7F
Description	MINI PCI E 52P 6.8mm 90D SMD AS0B226-S68N7H
Pin	Pin Name
1	WAKE#
2	+3.3VSB
3	NC
4	GND
5	NC
6	+1.5V
7	NC
8	NC
9	GND
10	NC
11	REFCLK-
12	NC
13	REFCLK+
14	NC
15	GND
16	NC
17	NC
18	GND
19	NC
20	NC
21	GND
22	PERST#
23	PERn0
24	+3.3VSB
25	PERp0
26	GND
27	GND
28	+1.5V
29	GND
30	SMB_CLK
31	PETn0
32	SMB_DAT
33	PETp0
34	GND
35	GND
36	USB D-
37	GND
38	USB D+
39	+3.3VSB
40	GND
41	+3.3VSB
42	NC
43	GND

44	NC
45	NC
46	NC
47	NC
48	+1.5V
49	NC
50	GND
51	NC
52	+3.3VSB
53	NC
54	NC
55	GND
56	GND

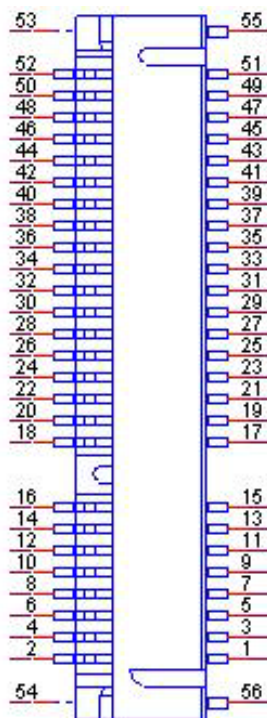

CN7 SIM Card	
Part Number	1654000639
Footprint	SIM-WL608C
Description	SIM card conn 6p 90D(F)SMD WO/Pb WL608C3-M04-7F
Pin	Pin Name
1	+VUIM_PWR
2	UIM_RESET
3	UIM_CLK
4	GND
5	+VUIM_VPP
6	UIM_DATA

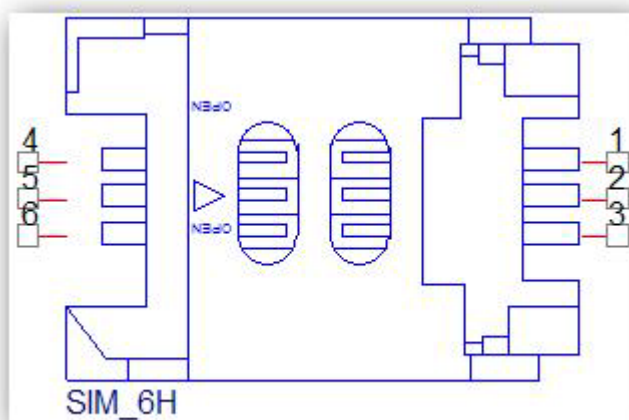

CN8 LPC	
Part Number	1653007220
Footprint	HD_7x2P_79_F_D
Description	PIN HEADER 7*2P 180D(F) 2.0mm
Pin	Pin Name
1	+5V
2	+5VSB
3	POWERGD
4	LPC_SERIRQ
5	LPC_DRQ#0
6	LPC_AD2
7	GND
8	LPC_AD3
9	GND
10	LPC_FRAME#
11	LPC_AD0
12	MIO_RST#
13	LPC_AD1
14	CLK33M_PCI0

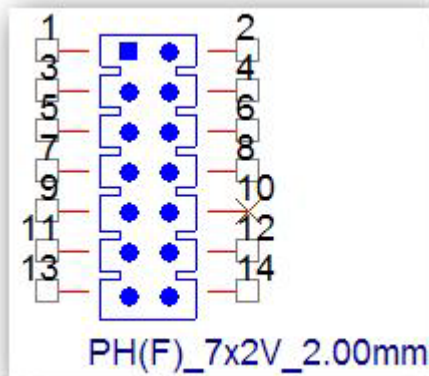

CN9 CPLD	
Part Number	1653008102
Footprint	HD_8x1P_100_D
Description	Pin Header 8*1P idiot- proof 180D pitch 2.54mm
Pin	Pin Name
1	+V3.3_JTAG
2	CPLD_z_TDO
3	CPLD_z_TDI
4	ispEN#
5	NC
6	CPLD_z_TMS
7	GND
8	CPLD_z_TCK

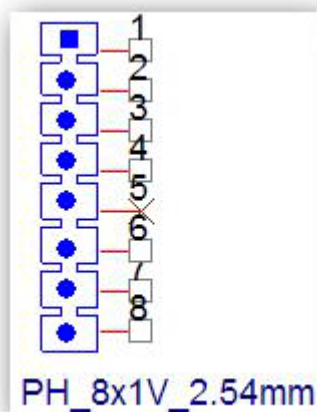

CN10 GPIO	
Part Number	1653004099
Footprint	HD_5x2P_79_23N685B-10M10
Description	BOX HEADER 5x2P 2.00mm 180D(M) SMD 23N685B-10M10
Pin	Pin Name
1	+VDD_CN_GPIO
2	GPIO0_D4
3	GPIO0_D0
4	GPIO0_D5
5	GPIO0_D1
6	GPIO0_D6
7	GPIO0_D2
8	GPIO0_D7
9	GPIO0_D3
10	GND

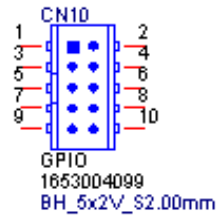

CN11 SATA_7P	
Part Number	1654004659
Footprint	SATA_7P_WATM-07DBN4A3B8UW_D
Description	Serial ATA Con 7p 180D(M)DIP 1.27mm WO/Pb(L=3.3)
Pin	Pin Name
1	GND
2	TX+
3	TX-
4	GND
5	RX-
6	RX+
7	GND

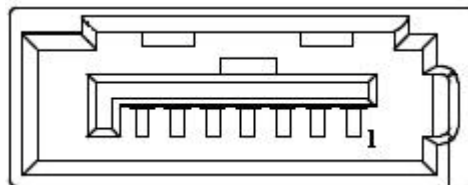

CN12 SATA_22P	
Part Number	1654003098
Footprint	WIN_WATB-22DL1PFU
Description	
Pin	Pin Name
P1	+V3.3
P2	+V3.3
P3	+V3.3
P4	GND
P5	GND
P6	GND
P7	+V5
P8	+V5
P9	+V5
P10	GND
P11	RSVD
P12	GND
P13	+V12
P14	+V12
P15	+V12
S1	GND
S2	SATA_TX+
S3	SATA_TX-
S4	GND
S5	SATA_RX-
S6	SATA_RX+
S7	GND

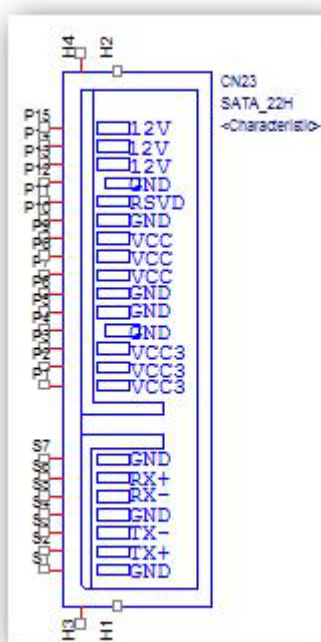

CN13 Power Button	
Part Number	1655302020
Footprint	WF_2P_79_BOX_R1_D
Description	WAFER BOX 2P 2.0mm 180D(M) DIP A2001WV2-2P
Pin	Pin Name
1	POWER_BUTTON
2	GND

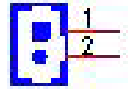

CN14 SMBus (from MIOe)	
Part Number	1655904020
Footprint	FPC4V-125M
Description	WAFER 4P 1.25mm 180D(M) SMD 85205-04001
Pin	Pin Name
1	GND
2	SMB_DAT
3	SMB_CLK
4	+5V

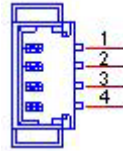

CN15 Reset Button	
Part Number	1655302020
Footprint	WF_2P_79_BOX_R1_D
Description	WAFER BOX 2P 2.0mm 180D(M) DIP A2001WV2-2P
Pin	Pin Name
1	RESET_BUTTON
2	GND



CN16 External 12V input power	
Part Number	1655000077
Footprint	ATXCON-2X12-42-1
Description	ATX PWR CONN. 2x2P 4.2mm 180D(M) DIP 24W4310-04S
Pin	Pin Name
1	GND
2	GND
3	+V12SB_EXT
4	+V12SB_EXT

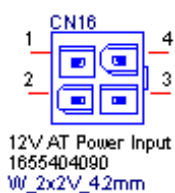

CN17 Display Port or HDMI *	
Part Number	1654003198
Footprint	KORTAK_EE082C0S-HN3Z
Description	
Pin	Pin Name
A1	NC
A2	+12V
A3	+12V
A4	GND
A5	NC
A6	NC
A7	NC
A8	NC
A9	+3.3V
A10	+3.3V
A11	PWRGD
A12	GND
A13	NC
A14	NC
A15	GND
A16	NC
A17	NC
A18	GND
A19	NC
A20	GND
A21	NC
A22	NC
A23	GND
A24	GND

A25	NC
A26	NC
A27	GND
A28	GND
A29	DDP_HPD
A30	NC
A31	GND
A32	NC
A33	NC
A34	GND
A35	DDP_AUX+
A36	DDP_AUX-
A37	GND
A38	GND
A39	NC
A40	NC
A41	GND
A42	GND
A43	NC
A44	NC
A45	GND
A46	GND
A47	NC
A48	NC
A49	GND
A50	NC
A51	GND
A52	NC
A53	NC
A54	GND
A55	GND
A56	NC
A57	NC
A58	GND
A59	GND
A60	NC
A61	NC
A62	GND
A63	GND
A64	NC
A65	NC
A66	GND
A67	GND
A68	NC
A69	NC
A70	GND
A71	GND
A72	NC
A73	NC

A74	GND
A75	GND
A76	NC
A77	NC
A78	GND
A79	GND
A80	NC
A81	NC
A82	GND
B1	+12V
B2	+12V
B3	+12V
B4	GND
B5	NC
B6	NC
B7	GND
B8	+3.3V
B9	NC
B10	+3.3VSB
B11	NC
B12	NC
B13	GND
B14	DDP_D0+
B15	DDP_D0-
B16	GND
B17	NC
B18	GND
B19	DDP_D1+
B20	DDP_D1-
B21	GND
B22	GND
B23	DDP_D2+
B24	DDP_D2-
B25	GND
B26	GND
B27	DDP_D3+
B28	DDP_D3-
B29	GND
B30	NC
B31	NC
B32	GND
B33	NC
B34	NC
B35	GND
B36	GND
B37	NC
B38	NC
B39	GND
B40	GND

B41	NC
B42	NC
B43	GND
B44	GND
B45	NC
B46	NC
B47	GND
B48	NC
B49	GND
B50	NC
B51	NC
B52	GND
B53	GND
B54	NC
B55	NC
B56	GND
B57	GND
B58	NC
B59	NC
B60	GND
B61	GND
B62	NC
B63	NC
B64	GND
B65	GND
B66	NC
B67	NC
B68	GND
B69	GND
B70	NC
B71	NC
B72	GND
B73	GND
B74	NC
B75	NC
B76	GND
B77	GND
B78	NC
B79	NC
B80	GND
B81	NC
B82	NC

* Depends on MI/O main board

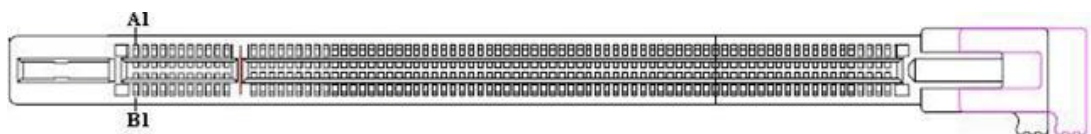

CN18 USB2.0 or USB3.0 *	
Part Number	1654009685
Footprint	USB_9P_UEA0112C-4FH1-4F
Description	
Pin	Pin Name
1	+5V
2	D-
3	D+
4	GND
5	SSRX-
6	SSRX+
7	GND
8	SSTX-
9	SSTX+

* Depends on MI/O main board

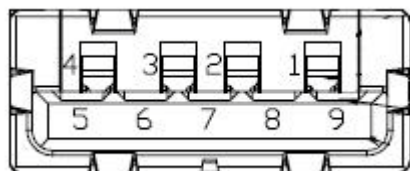

CN19 USB2.0	
Part Number	1654005935
Footprint	USB_4P_UB0112
Description	
Pin	Pin Name
1	+5V
2	D-
3	D+
4	GND

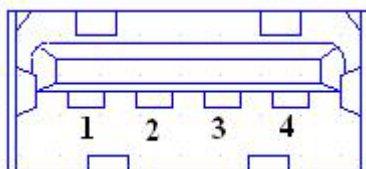

CN20 Audio Line Out	
Part Number	1652505205
Footprint	FOX_JA13331-N24B-4F
Description	PHONE JACK 3.5" 5P 90D(F) LIME W/SHIELDED
Pin	Pin Name
1	GND_AUD
2	LINEOUT_L
3	LINEOUT_L
4	LINEOUT_R
5	LINEOUT_R

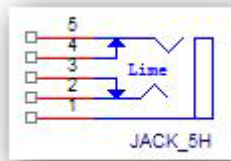

CN21, CN22 FAN_ W_3V_2.54mm	
Part Number	1655003010
Footprint	WHP3VA
Description	Wafer 2.54mm 3P 180D(M) DIP W/LOCK 22-27-2031
Pin	Pin Name
1	GND
2	+V12
3	NC

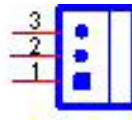

SW1 Power_WB_2V_2.00mm	
Part Number	1601000501
Footprint	SW_4P_236x236_H197
Description	PUSH SW STS-B5 SMD 4P H=5.0mm
Pin	Pin Name
1	POWER_BUTTON
2	NC
4	GND
5	NC

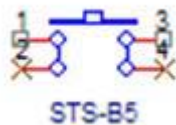

SW2 Reset_WB_2V_2.00mm

Part Number 1601000501

Footprint SW_4P_236x236_H197

Description PUSH SW STS-B5 SMD 4P H=5.0mm

Pin	Pin Name
-----	----------

1	RESET_BUTTON
---	--------------

2	NC
---	----

6	GND
---	-----

7	NC
---	----

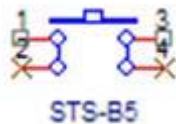

ADVANTECH

Enabling an Intelligent Planet

www.advantech.com

Please verify specifications before quoting. This guide is intended for reference purposes only.

All product specifications are subject to change without notice.

No part of this publication may be reproduced in any form or by any means, electronic, photocopying, recording or otherwise, without prior written permission of the publisher.

All brand and product names are trademarks or registered trademarks of their respective companies.

© Advantech Co., Ltd. 2012

Free Manuals Download Website

<http://myh66.com>

<http://usermanuals.us>

<http://www.somanuals.com>

<http://www.4manuals.cc>

<http://www.manual-lib.com>

<http://www.404manual.com>

<http://www.luxmanual.com>

<http://aubethermostatmanual.com>

Golf course search by state

<http://golfingnear.com>

Email search by domain

<http://emailbydomain.com>

Auto manuals search

<http://auto.somanuals.com>

TV manuals search

<http://tv.somanuals.com>