

# Aspire easyStore H340

## User Guide

Copyright © 2009 Acer Incorporated  
All Rights Reserved.

Aspire easyStore H340  
User Guide

Changes may be made periodically to the information in this publication without obligation to notify any person of such revision or changes. Such changes will be incorporated in new editions of this manual or supplementary documents and publications. This company makes no representations or warranties, either expressed or implied, with respect to the contents hereof and specifically disclaims the implied warranties of merchantability or fitness for a particular purpose.

Record the model number, serial number, purchase date, and place of purchase information in the space provided below. The serial number and model number are recorded on the label affixed to your server. All correspondence concerning your unit should include the serial number, model number, and purchase information.

No part of this publication may be reproduced, stored in a retrieval system, or transmitted, in any form or by any means, electronic, mechanical, photocopy, recording, or otherwise, without the prior written permission of Acer Incorporated.

Aspire easyStore H340

Model Name : \_\_\_\_\_

Part Number: \_\_\_\_\_

Purchase Date: \_\_\_\_\_

Place of Purchase: \_\_\_\_\_

Acer and the Acer logo are registered trademarks of Acer Inc. Other company's product names or trademarks are used herein for identification purposes only and belong to their respective companies.

# Safety instructions

Read these instructions carefully. Keep this document for future reference. Follow all warnings and instructions marked on the product.

## Turning the product off before cleaning

Unplug this product from the wall outlet before cleaning. Do not use liquid cleaners or aerosol cleaners. Use a damp cloth for cleaning.

## CAUTION for plug as disconnecting device

Observe the following guidelines when connecting and disconnecting power to the power supply unit:

Install the power supply unit before connecting the power cord to the AC power outlet.

Unplug the power cord before removing the power supply unit from the computer.

If the system has multiple sources of power, disconnect power from the system by unplugging all power cords from the power supplies.

## CAUTION for Accessibility

Be sure that the power outlet you plug the power cord into is easily accessible and located as close to the equipment operator as possible. When you need to disconnect power to the equipment, be sure to unplug the power cord from the electrical outlet.

## CAUTION for Listening

To protect your hearing, follow these instructions.

- Increase the volume gradually until you can hear clearly and comfortably.
- Do not increase the volume level after your ears have adjusted.
- Do not listen to music at high volumes for extended periods.
- Do not increase the volume to block out noisy surroundings.
- Decrease the volume if you can't hear people speaking near you.

## Warnings

- Do not use this product near water.
- Do not place this product on an unstable cart, stand or table. If the product falls, it could be seriously damaged.
- Slots and openings are provided for ventilation to ensure reliable operation of the product and to protect it from overheating. These openings must not be blocked or covered. The openings should never be blocked by placing the product on a bed, sofa, rug or other similar surface. This product should never be placed near or over a radiator or heat register, or in a built-in installation unless proper ventilation is provided.
- Never push objects of any kind into this product through cabinet slots as they may touch dangerous voltage points or short-out parts that could result in a fire or electric shock. Never spill liquid of any kind onto or into the product.
- To avoid damage of internal components and to prevent battery leakage, do not place the product on a vibrating surface.
- Never use it under sporting, exercising, or any vibrating environment which will probably cause unexpected short current or damage rotor devices, HDD, Optical drive, and even exposure risk from lithium battery pack.
- The bottom surface, areas around ventilation openings and AC adapter may get hot. To avoid injury, ensure they do not come in contact with yourskin or body.
- Your device and its enhancements may contain small parts. Keep them out of the reach of small children.

## Using electrical power

- This product should be operated from the type of power indicated on the marking label. If you are not sure of the type of power available, consult your dealer or local power company.
- Do not allow anything to rest on the power cord. Do not locate this product where people will walk on the cord.
- If an extension cord is used with this product, make sure that the total ampere rating of the equipment plugged into the extension cord does not exceed the extension cord ampere rating. Also, make sure that the total rating of all products plugged into the wall outlet does not exceed the fuse rating.

- Do not overload a power outlet, strip or receptacle by plugging in too many devices. The overall system load must not exceed 80% of the branch circuit rating. If power strips are used, the load should not exceed 80% of the power strip's input rating.
- This product's power supply is equipped with a three-wire grounded plug. The plug only fits in a grounded power outlet. Make sure the power outlet is properly grounded before inserting the power supply plug. Do not insert the plug into a non-grounded power outlet. Contact your electrician for details.



-----

**Warning! The grounding pin is a safety feature. Using a power outlet that is not properly grounded may result in electric shock and/or injury.**



-----

**Note:** The grounding pin also provides good protection from unexpected noise produced by other nearby electrical devices that may interfere with the performance of this product.

- The system can be powered using a wide range of voltages; 100 to 240 V AC. The power cord included with the system meets the requirements for use in the country/region where the system was purchased. Power cords for use in other countries/regions must meet the requirements for that country/region. For more information on power cord requirements, contact an authorized reseller or service provider.

## Product servicing

Do not attempt to service this product yourself, as opening or removing covers may expose you to dangerous voltage points or other risks. Refer all servicing to qualified service personnel.

Unplug this product from the wall outlet and refer servicing to qualified service personnel when:

- the power cord or plug is damaged, cut or frayed
- liquid was spilled into the product
- the product was exposed to rain or water
- the product has been dropped or the case has been damaged
- the product exhibits a distinct change in performance, indicating a need for service
- the product does not operate normally after following the operating instructions



-----

**Note:** Adjust only those controls that are covered by the operating instructions, since improper adjustment of other controls may result in damage and will often require extensive work by a qualified technician to restore the product to normal condition.

## Disposal instructions

Do not throw this electronic device into the trash when discarding. To minimize pollution and ensure utmost protection of the global environment, please recycle. For more information on the Waste from Electrical and Electronics Equipment (WEEE) regulations, visit <http://global.acer.com/about/sustainability.htm>



# Regulations and safety notices

## FCC statement

This device has been tested and found to comply with the limits for a Class B digital device pursuant to Part 15 of the FCC rules. These limits are designed to provide reasonable protection against harmful interference in a residential installation. This device generates, uses, and can radiate radio frequency energy and, if not installed and used in accordance with the instructions, may cause harmful interference to radio communications.

However, there is no guarantee that interference will not occur in a particular installation. If this device does cause harmful interference to radio or television reception, which can be determined by turning the device off and on, the user is encouraged to try to correct the interference by one or more of the following measures:

- Reorient or relocate the receiving antenna
- Increase the separation between the device and receiver
- Connect the device into an outlet on a circuit different from that to which the receiver is connected
- Consult the dealer or an experienced radio/television technician for help

## Notice: Shielded cables

All connections to other computing devices must be made using shielded cables to maintain compliance with FCC regulations.

## Notice: Peripheral devices

Only peripherals (input/output devices, terminals, printers, etc.) certified to comply with the Class A limits may be attached to this equipment. Operation with noncertified peripherals is likely to result in interference to radio and TV reception.

## Caution

Changes or modifications not expressly approved by the manufacturer could void the user's authority, which is granted by the Federal Communications Commission, to operate this server.

## Notice Canadian users

This Class B digital apparatus complies with Canadian ICES-003.

## Remarque à l'intention des utilisateurs canadiens

Cet appareil numérique de la classe B est conforme à la norme NMB-003 du Canada.

Compliant with Russian regulatory certification



ME61



**Acer Incorporated**

333 West San Carlos St. San Jose,  
CA 95110, U.S.A.  
Tel: 254-298-4000  
Fax: 254-298-4147  
[www.acer.com](http://www.acer.com)

**Federal Communications Commission  
Declaration of Conformity**

This device complies with Part 15 of the FCC Rules. Operation is subject to the following two conditions: (1) This device may not cause harmful interference, and (2) This device must accept any interference received, including interference that may cause undesired operation.

The following local Manufacturer/Importer is responsible for this declaration:

Product:	Server
Model number:	Aspire easyStore H340, Altos easyStore M2
Name of responsible party:	Acer America Corporation
Address of responsible party:	333 West San Carlos St. San Jose, CA 95110 U.S.A.
Contact person:	Acer Representative
Tel:	254-298-4000
Fax:	254-298-4147

Acer Incorporated  
8F, 88, Sec.1, Hsin Tai Wu Rd., Hsichih  
Taipei Hsien 221, Taiwan

## Declaration of Conformity

**We,**

Acer Computer (Shanghai) Limited

8F, 88, Sec.1, Hsin Tai Wu Rd., Hsichih, Taipei Hsien 221, Taiwan

Contact Person: Mr. Easy Lai

Tel: 886-2-8691-3089 Fax: 886-2-8691-3120

E-mail: [easy\\_lai@acer.com.tw](mailto:easy_lai@acer.com.tw)

Hereby declare that:

**Product:** Server  
**Trade Name:** Acer  
**Model Number:** Aspire easyStore H340,  
Altos easyStore M2

Is compliant with the essential requirements and other relevant provisions of the following EC directives, and that all the necessary steps have been taken and are in force to assure that production units of the same product will continue comply with the requirements.

EMC Directive 2004/108/EC as attested by conformity with the following harmonized standards:

- EN55022: 2006, AS/NZS CISPR22: 2006, Class B
- EN55024: 1998 + A1: 2001 + A2:2003
- EN55013:2001 + A1:2003 + A2:2006 (Applicable to product built with TV tuner module)
- EN55020:2007 (Applicable to product built with TV tuner module)
- EN61000-3-2: 2006, Class D
- EN61000-3-3: 1995 + A1: 2001+A2: 2005

Low Voltage Directive 2006/95/EC as attested by conformity with the following harmonized standard:

- EN60950-1: 2001 + A11: 2004
- EN60065: 2002 + A1: 2006 (Applicable to product built with TV tuner module)

Council Decision 98/482/EC (CTR21) for pan- European single terminal connection to the Public Switched Telephone Network (PSTN).

RoHS Directive 2002/95/EC on the Restriction of the Use of certain Hazardous Substances in Electrical and Electronic Equipment

The standards listed below are applied to the product if built with WLAN module or wireless keyboard and mouse.

R&TTE Directive 1999/5/EC as attested by conformity with the following harmonized standard:

- Article 3.1(a) Health and Safety
  - EN60950-1:2001 + A11:2004
  - EN50371:2002
- Article 3.1(b) EMC
  - EN301 489-1 V1.6.1
  - EN301 489-3 V1.4.1 (Applicable to non-bluetooth wireless keyboard mouse set)
  - EN301 489-17 V1.2.1
- Article 3.2 Spectrum Usages
  - EN300 440-2 V1.1.2 (Applicable to non-bluetooth wireless keyboard mouse set)
  - EN300 328 V1.7.1
  - EN301 893 V1.4.1 (Applicable to 5GHz high performance RLAN)

Year to begin affixing CE marking 2009.

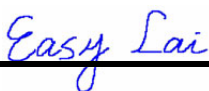

Easy Lai, Manager  
Regulation Center, Acer Inc.

January 7, 2009

Date



# Contents

1 Introduction	1
Features	2
Specifications	3
Overview	4
Front view	4
Rear view	5
System LED indicators	6
2 Setting up the system	11
Check package contents	12
Select a location	13
Recommended environment	14
Connect the power cord	15
Connect to the home network	16
Power on the system	17
Install the Windows Home Server Connector on the first computer	18
Install the Windows Home Server Connector on the client computers	31
Connect to the Home Server Console	34
3 Windows Home Server Console	37
Computers & Backup	38
User Accounts	39
Shared Folders	40
Server Storage	42
Lights Out	43
McAfee Total Protection	44
System Information	45
Network Health	47
Settings	49
General	50
Backup	51
Passwords	52
Media Sharing	53
Remote Access	54
Add-ins	54
Hardware Health and Performance Monitor	55
IP Configuration	56
Lights Out	57
McAfee Total Protection Service	58
Settings for DMS	59

Settings for iTunes Server	60
Resources	61
Shut Down	61
4 Managing the server	63
Create user accounts	64
Add a shared folder	69
Configure backup for home computers	71
Back up the home server	72
Configure the home server for remote access	76
Access the Aspire easyStore H340 home page	79
Access the shared folders on the home server	81
Enable media sharing	84
Enable Digital Media Server	85
Enable iTunes service	87
Stream audio	88
Using the one-touch USB backup feature	91
Set up Wake On LAN on the home server	93
Set the home server uptime and down time	96
Monitor server health and performance	99
Set up email alerts	100
Explore the Windows Home Server icon	105
5 Configuring the hard disk drive	107
Adding a hard disk drive	107
Removing a hard disk drive	112
Replacing a failed hard disk drive	114
6 Troubleshooting	117
First steps checklist	117
Recovering or restoring the home server	118
Restoring a home computer	123
Restoring files from a backup	125
Update your home server with Aspire easyStore H340	
Software Update	126
Specific problems and corrective actions	131

# 1 Introduction

Thank you for choosing Aspire easyStore H340.

The Aspire easyStore H340 is a data storage and digital media content server for your digital home. Featuring an Intel® Atom™ processor, up to 2 GB memory, four-drive hot-swap bay\*, Gigabit Ethernet, eSATA and four USB ports for extended storage, a USB backup port for backing up data from a USB storage device, and a recovery/reset button to recover from a system failure or reset the system to factory default.

Aspire easyStore H340 can store and share all your important data while simultaneously streaming digital media content to multiple applications including Apple iTunes or any Universal Plug and Play (UPnP) Audio/Video and Digital Living Network Alliance™ (DLNA) compliant device, such as PS3 or Xbox 360. It allows you to consolidate your content library yet maintain instant access to digital media.

\* Only hard disk drives installed in the drive bays 2, 3, and 4 are hot-swappable. The system hard drive located on the 1st drive bay is not hot-swappable. See "Front view" on page 4 for the location of the drive bay.

# Features

- Powerful processor with excellent file sharing performance.
- Fast network performance in the home is delivered through a Gigabit Ethernet connection.
- Equipped with Microsoft's Windows Home Server operating system to help you centralize and connect your digital assets.
- Back up home computers daily. See "Configure backup for home computers" on page 71 for more information.
- Easily access your music, photos, and videos from virtually any Internet connected computer on a home network or while away from home. See "Access the shared folders on the home server" on page 81 for more information.
- One-touch USB backup feature enables quick and easy backup of your data from a USB storage device. See "Using the one-touch USB backup feature" on page 91 for more information.
- Easily add storage space to the home server. See "Adding a hard disk drive" on page 107 for more information.
- Windows Media Player and iTunes streaming support. See "Stream audio" on page 88 for more information.
- Remotely wake up the home server. See "Set up Wake On LAN on the home server" on page 93.







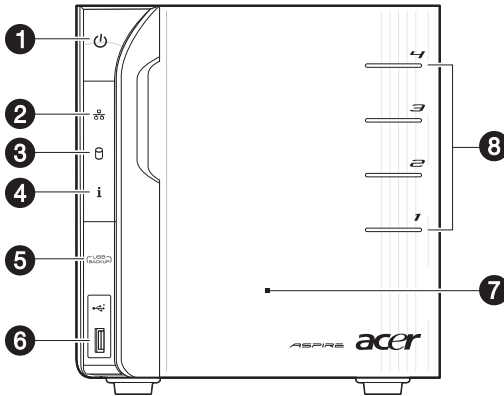

# Specifications

Processor	Intel® Atom™ Processor
Chipset	Intel 945GC Express Chipset and ICH7R
Drive storage	Up to four 3.5-inch hot-swappable SATA hard disk drives (HDD)
Memory	Up to 2 GB DDR2 MHz unbuffered SDRAM
Ethernet	High performance (10/100/1000) Gigabit Ethernet port
I/O ports	USB 2.0 ports (1 front and 4 rear), Gigabit Ethernet port, eSATA port, recovery/reset button
Power	200 W, 100-240 V AC
Server operating system (OS) support	Windows Home Server
Home computer OS support	Windows Vista 32-bit and 64-bit Edition Windows XP 32-bit and 64-bit Edition
Digital media player support	Any DLNA certified device
Digital media file support	<ul style="list-style-type: none"> <li>• Music: MP3, WMA, WAV, AAC, AC3, FLAC, APE, OGG, VOC, AIFF, AU, MID</li> <li>• Video: WMV, ASF, MOV, AVI, MPEG, 3GP, SWF, FLV, RMVB, RM, RA, RAM, MP4, MPG, MPE, M2V, TP, TS, MLV, MKV, DIVX</li> <li>• Photos: GIF, PNG, BMP, JPG, JPEG, ICO, TIFF, DXF, WMF, EMF, PICT, EPS, CDR</li> </ul>
Physical dimensions	WxHxD: 200 x 180 x 212 mm Weight (without HDD): 4.5 kg (with 1 HDD): 5.1 kg

# Overview

## Front view



No.	Icon	Component
1		Power button/power indicator
2		Network indicator
3		Hard disk drive (HDD) status indicator
4		System status indicator
5		USB backup button/USB backup indicator
6		USB 2.0 port
7		Front door Open the door to access the hot-swappable HDDs
8		HDD access indicators

## Rear view

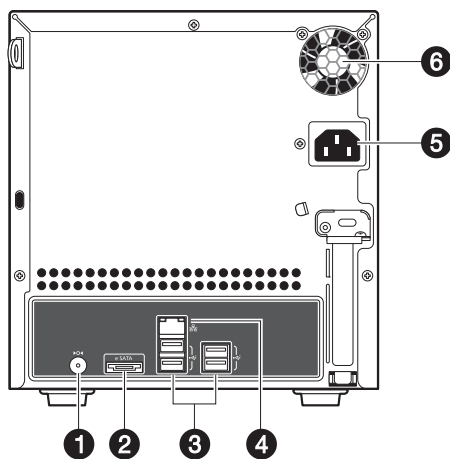



No.	Icon	Component
1		Recovery/reset button
2	eSATA	eSATA port
3		USB port
4		Gigabit Ethernet port
5		Power connector
6		System fan

# System LED indicators

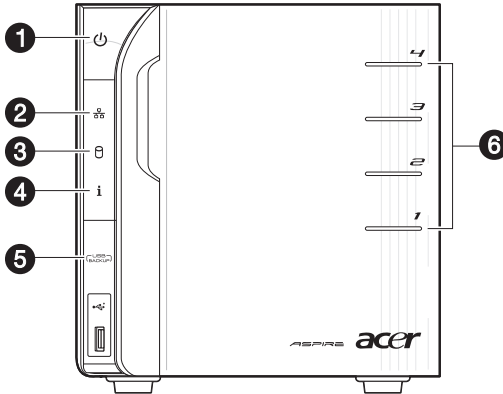

## Front panel LED indicators

The LED indicators mounted on the front panel provide information about the status of the system, its hard drives, and network connection.



No.	Indicator	Color	State	Description
1	Power button 	Blue	On	System is connected to the power supply and turned on and ready for use
			Random blink	<ul style="list-style-type: none"> <li>System is booting</li> <li>System is in S3 sleep state (suspend to memory)</li> </ul>
			Off	<ul style="list-style-type: none"> <li>System is not powered on</li> <li>System initialize operation in progress</li> </ul>
2	Network 	Blue	On	Link between system and network
			Random blink	Network access
		Red	Off	Network disconnected

No.	Indicator	Color	State	Description
3	HDD status (4) 	Purple	On	<ul style="list-style-type: none"> <li>System not initialized</li> <li>HDD is not mounted into the drive bay</li> </ul>
			Random blink	<ul style="list-style-type: none"> <li>HDD is mounted into the drive bay and is in the process of being manually added into the server storage</li> <li>HDD is in the process of being removed from the server storage.</li> </ul> <p>For detailed instructions on how to add or remove a drive from the server storage, see "5 Configuring the hard disk drive" on page 107.</p>
		Blue	On	<p>HDD is mounted into the drive bay and added into the server storage</p> <p>For detailed instructions on how to add a drive into the server storage, see "Adding a hard disk drive" on page 107.</p>
		Red	Random blink	<ul style="list-style-type: none"> <li>HDD failure</li> <li>Windows Home Server cannot find HDD</li> </ul>
		None	Off	No HDD mounted in the drive bay.

No.	Indicator	Color	State	Description
4	System status 	Blue	Random blink	<ul style="list-style-type: none"> <li>System is booting</li> <li>System is shutting down</li> </ul>
			On	System initialize operation completed.
		Blue and Purple	Random blink	System is booting from a USB device (Reserved for BIOS update while boot block has been active)
		Red	On	May indicate the following states: <ul style="list-style-type: none"> <li>System failure</li> <li>HDD failure</li> <li>SATA controller failure</li> <li>USB controller failure</li> <li>LAN controller failure</li> <li>FAN failure</li> <li>Memory failure</li> <li>Boot device not found</li> </ul>
			Random blink	System recovery or reset is in progress
5	USB device backup 	Blue	On	<ul style="list-style-type: none"> <li>USB storage device is connected to the USB port</li> <li>Backup completed</li> </ul>
			Random blink	System is backing up files from a USB storage device For detailed instructions on how to back up files from a USB storage device, see "Using the one-touch USB backup feature" on page 91.
			Off	USB storage device unmounted
6	HDD access	Blue	Blink	HDD is in use
			Off	No HDD activity

## Gigabit Ethernet port LED indicators

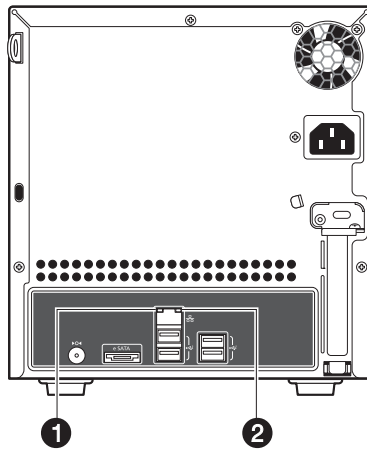

No.	Indicator	Color	State	Description
1	Speed indicator	None	Off	10 Mbps connection
		Green	On	100 Mbps connection
		Amber	On	1000 Mbps connection
2	Link/activity indicator	Green	On	Network link is detected
			Random blink	Transmit or receive activity
			Off	No network connection





# 2 Setting up the system

Follow these steps to set up Aspire easyStore H340 to run in your home network.

- Check package contents
- Select a location for the home server
- Recommended environment
- Connect the power cord
- Connect to the home network
- Power on the system
- Install the Windows Home Server Connector on the first computer
- Install the Windows Home Server Connector on the client computers
- Connect to the Home Server Console

# Check package contents

Check the following items from the package:

- Aspire easyStore H340 system
- Power cord
- Network cable
- Aspire easyStore H340 Installation discs
  - Software Installation Disc

Use this disc to do the following:

- Install the Windows Home Server Connector software. Refer to "Install the Windows Home Server Connector on the first computer" on page 18 for detailed instructions.
- Install the Lights Out Client. Refer to "Set up Wake On LAN on the home server" on page 93.
- Update system driver, BIOS, and add-in softwares. Refer to "Update your home server with Aspire easyStore H340 Software Update" on page 126.
- Server Recovery Disc - Use this disc to recover your home server after a system failure or restore the home server to its factory default. Refer to "Recovering or restoring the home server" on page 118 for detailed instructions.
- PC Recovery Disc - Use this disc restore a home computer from a backup stored on your home server. Refer to "Restoring a home computer" on page 123 for detailed instructions.
- Quick Start Guide
- Warranty card

If any of the above items are damaged or missing, contact your reseller or retailer from which you purchased this product.

## Select a location

Before unpacking and installing the system, select a suitable site for the system for maximum efficiency. Consider the following factors when choosing a site for the system:

- Near a grounded power outlet
- Clean and dust free
- Stable surface free from vibration
- Well-ventilated and away from sources of heat
- Secluded from electromagnetic fields produced by electrical devices such as air conditioners, radio, TV transmitters, etc.

# Recommended environment

For best results, your computer should meet the following hardware and software requirements:

- Processor
  - 1 GHz Pentium 3, Pentium 4, AMD x64, or newer processor
- System memory
  - 512 MB or above
- Hard drives
  - 80 GB internal (ATA, SATA, or SCSI) as primary drive
- Operating system
  - Windows Vista Home Basic
  - Windows Vista Home N (EU only)
  - Windows Vista Home Premium
  - Windows Vista Business
  - Windows Vista Business N (EU only)
  - Windows Vista Enterprise
  - Windows Vista Ultimate
  - Windows XP Home with Service Pack 2 (SP2)
  - Windows XP Professional with SP2
  - Windows XP Media Center Edition 2005 with SP2 and Rollup 2
  - Windows XP Media Center Edition 2004/2005 with SP2
  - Windows XP Tablet Edition with SP2
- Web browsers
  - Internet Explorer version 6.0, 7.0, or above
  - Mozilla Firefox 1.5 or above
- Internet connection
  - 100 Mbps to 1000 Mbps Gigabit Ethernet connection
  - Broadband connection (DSL or cable)
- Broadband router (DHCP enabled)
- Digital media player for streaming media files
  - iTunes 7.1 or later
  - Windows Media Player 10 or later

## Connect the power cord

Plug the power cord into the power connector and the other end into an electrical outlet.

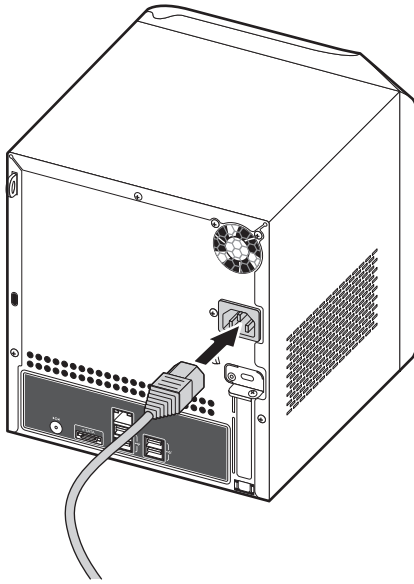

# Connect to the home network



**Important:** Connect the Aspire easyStore H340 to your broadband router with a network cable. Wireless connection to your broadband router is not supported. However, home computers that are connected through a wireless connection is supported.

Connect one end of the network cable into the network port and the other end to a Gigabit Ethernet port on a broadband router.

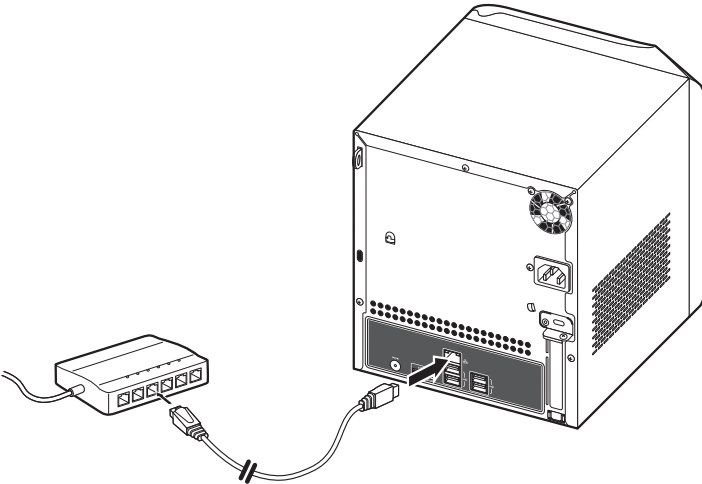

# Power on the system

After making sure that you have set up the system properly and connected all the required cables, you can now power on the system.

Press the power button to turn system on. The LED indicators on the front panel will flash, change colors and turn to solid blue after startup.



**Note:** During initial startup, the system status indicator **i** on the front panel will flash red and turn to solid blue. This is a normal power-up sequence. Wait for all the LED indicators to turn solid blue before proceeding to the next section.

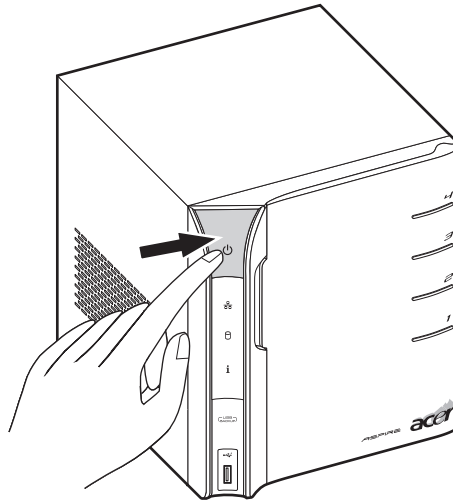

To power down the system, press and hold the power button down for at least four seconds.

# Install the Windows Home Server Connector on the first computer

After setting up your Aspire easyStore H340, you must install the Windows Home Server Connector on your computer.



**Note:** Prior to installing the Windows Home Server Connector, make sure you have administrator privileges. Refer to the Windows Help for more details on changing your user account settings.

- 1 Place the Aspire easyStore H340 Software Installation Disc in the optical drive of the first home computer. The installation wizard starts.

Or, double-click on the **Acer ClientCD Utility.exe** file to begin installation. The Welcome window appears.





- 2 Click **Next**.

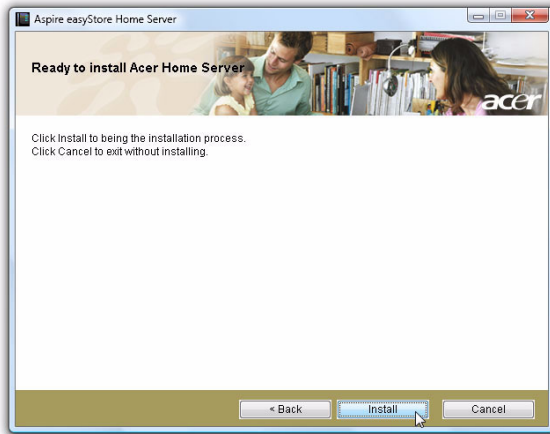

- 3 Click **Install** to begin the installation process. The Microsoft .Net Framework 2.0 and Windows Installer 3.1 components are installed.

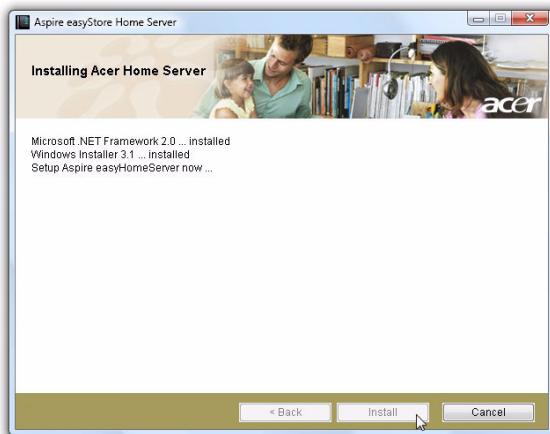

After the components are installed, the Windows Home Server Connector installation starts to find and connect to your Aspire easyStore H340.

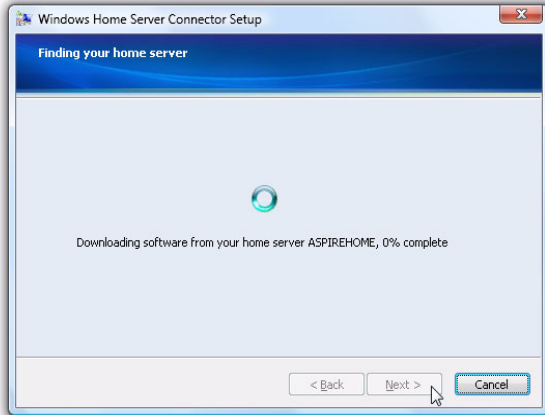

Once the server is found, the Welcome window appears.



4 Click **Next**.

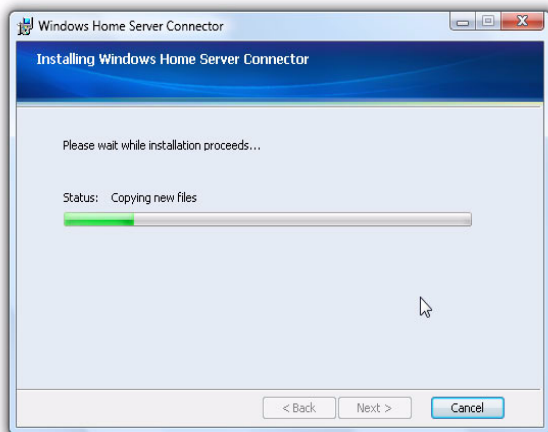

5 Click **Next**.



6 Select the "Download the updates from my home server and install them automatically" option button if you want to download the updates for the Connector.

7 Click **Next**.

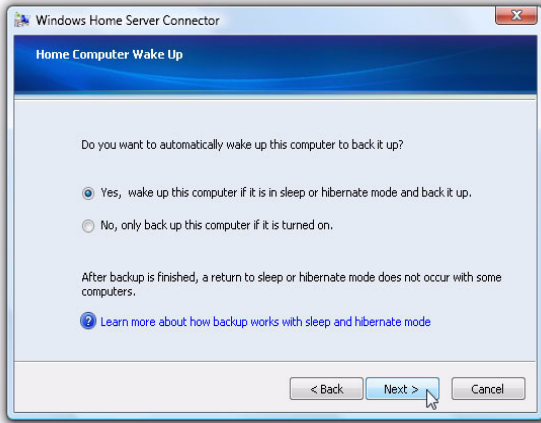

8 Select the "Yes, wake up this computer if it is in sleep or hibernate mode and back it up" option button if you want Windows Home Server to wake up your sleeping computer to back it up.

9 Click **Next**.

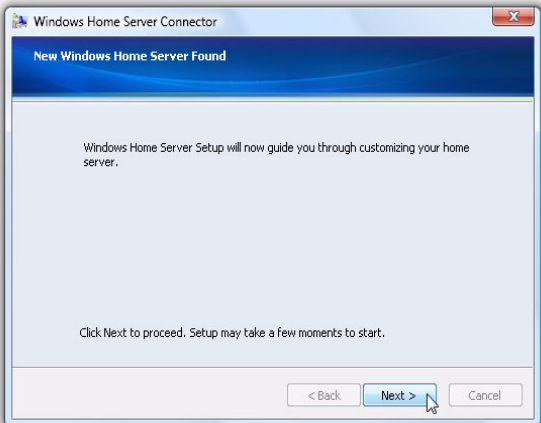

- 10 Click **Next** to perform an initial configuration of the home server.



.....  
**Note:** The initial configuration of the home server is performed once on the first home computer.

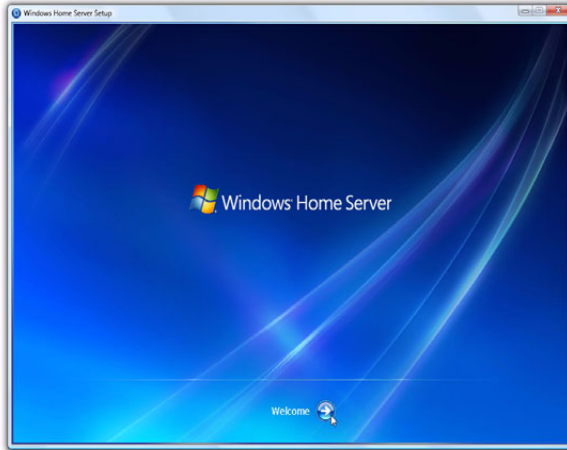

- 11 Click the **Next** arrow. The Windows Home Server initialization begins and could take several hours depending on your hardware.

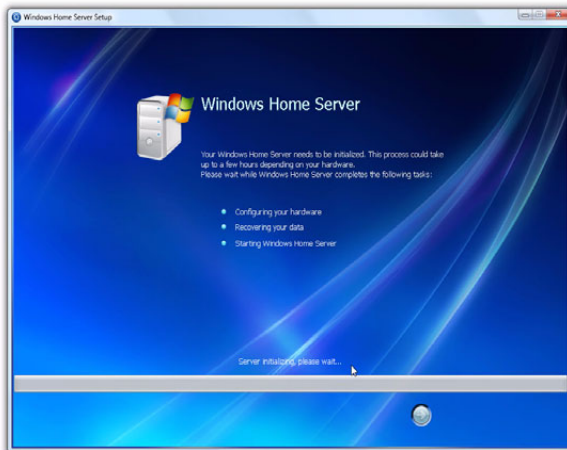

- 12 Once the initialization is completed, click the **Next** arrow.

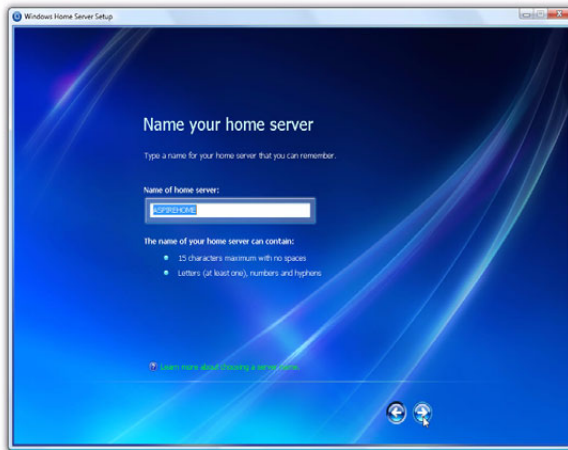

- 13 Enter a name for your home server.

The name of your home server can contain a maximum of 15 characters (includes letters, numbers or hyphens) with no spaces.

- 14 Click the **Next** arrow.

- 15 Enter a strong Windows Home Server administrator password, confirmation password, and a password hint. This is the password that you can use to manage your home server from the Windows Home Server Console.

The strong password must be at least 7 characters and must contain at least three of the following four categories:

- Uppercase letters
- Lowercase letters
- Numbers
- Symbols (such as !, @, #, etc.)

An example of a strong password is Acer123.



16 Click the **Next** arrow.

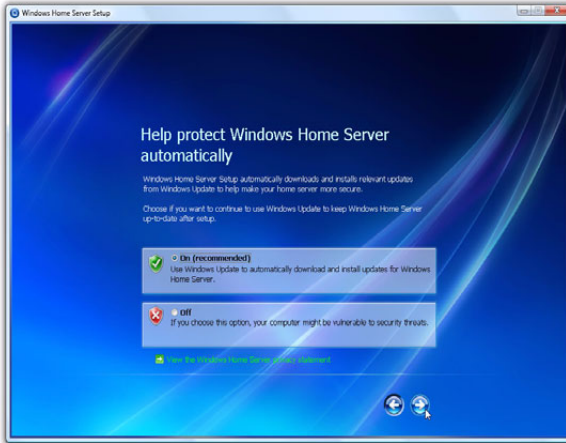

17 Select the "On (recommended)" option button if you want to use Windows Update to automatically download and install updates for Windows Home Server, then click the **Next** arrow.

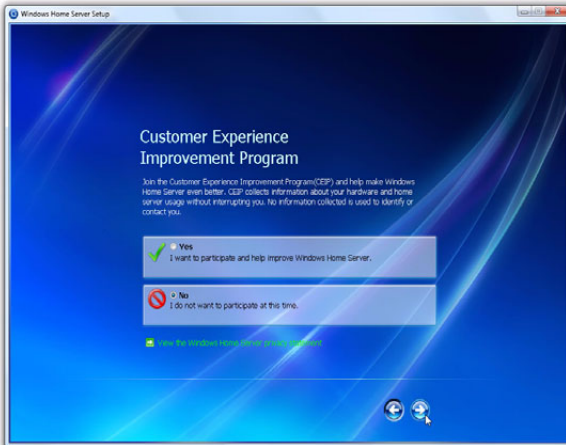



- 18 Choose if you want to participate in the Customer Experience Improvement program, then click the **Next** arrow.



- 19 Choose if you want to participate in the Windows Error Reporting program, then click the **Next** arrow.

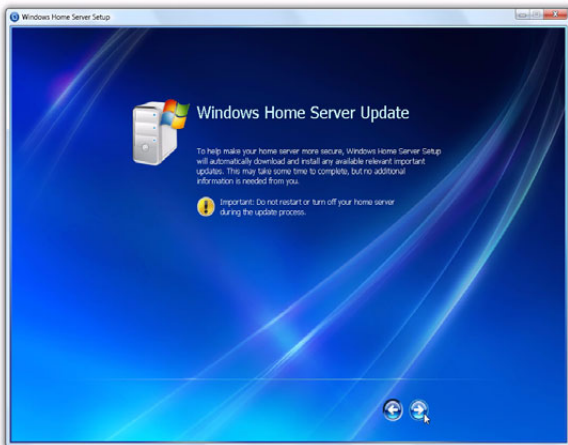

- 20 Click the **Next** arrow to automatically download and install available Windows Home Server updates. This could take some time to complete but will not need additional information from you.



-----  
**Important:** Do not restart or turn off your home server during the update process.

- 21 Once installation is complete the Windows Home Server windows displays.

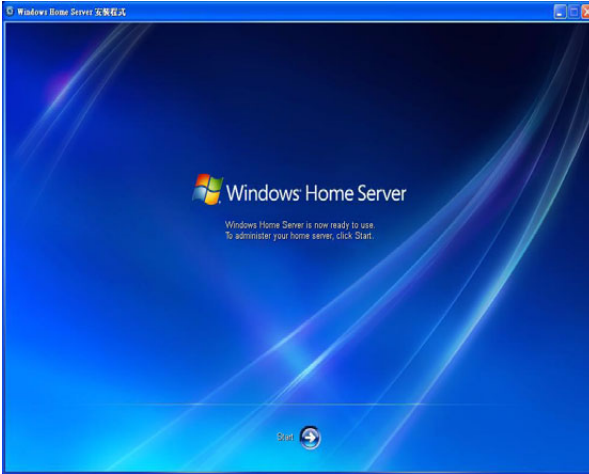

- 22 Click the **Next** arrow. The Windows Home Server log in window displays. You can now manage the home server through the remote admin console.

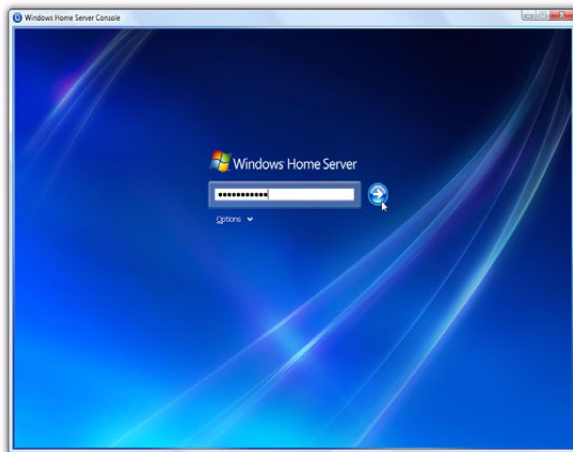



- 23 Enter the administrator password, then click the **Next** arrow. The Setting Password dialog box appears.

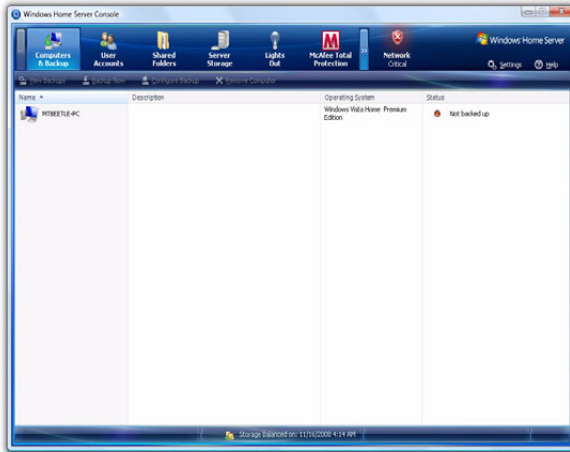

- 24 Enter the administrator password to start the hardware health and performance monitor service, then click **OK**. The Windows Home Server Console window appears.



The Windows Home Server icon  also appears in the system task tray and the Shared Folders desktop shortcut  appears on your desktop.

The Windows Home Server icon displays the current health and status of the home server as well as all the computers connected to your home network. Right-clicking on the icon allows access to the Windows Home Server. For more information about the system tray icon refer to “Explore the Windows Home Server icon” on page 105.

You can also use Shared Folders to store and organize files on the home server.

# Install the Windows Home Server Connector on the client computers

After installing the Windows Home Server Connector on the first computer, use the Aspire easyStore H340 Software Installation Disc to install the Windows Home Server Connector on the computers you want to connect to your home server.

If you have misplaced the disc, you can install the Windows Home Server Connector via the home server. Refer to page 33 for detailed instructions.

To install the Windows Home Server connector from the Aspire easyStore H340 Software Installation Disc

- 1 Place the Aspire easyStore H340 Software Installation Disc in the optical drive of the client computer. The installation wizard starts.

Or, double-click on the **Acer ClientCD Utility.exe** file to begin installation. The Welcome window appears.





- 2 Click **Next**.
- 3 Click **Install** to begin the installation process. The Microsoft .Net Framework 2.0, Windows Installer 3.1, and Acer Update, and Aspire easyStore H340 components are installed.

- 4 After the components are installed, the Windows Home Server Connector installation starts to find and connect to your home server.

Once the home server is found, the Welcome window appears.

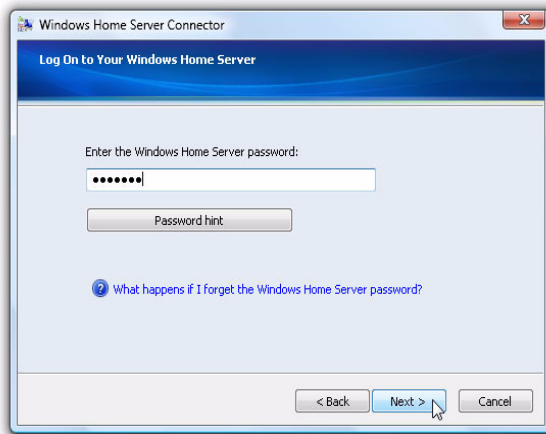
- 5 Click **Next**.
- 6 Read the End-User License Agreement. If you agree with the terms of the agreement, then select the "I accept the terms of the license agreement" option button.
- 7 Click **Next**. The installation status window appears.
- 8 Click **Next**.
- 9 Enter the Windows Home Server administrator password.



- 10 Click **Next** and follow all onscreen instructions until you finish installation.
- 11 Once installation is complete the Windows Home Server icon  appears in the system task tray and the Shared Folders desktop shortcut  appears on your desktop.

To install the Windows Home Server connector directly from the home server

- 1 Open a Web browser.
- 2 In the address bar, enter `http://Aspirehome:55000/`, where "Aspirehome" is the name of the home server.
- 3 Under Windows Home Server Connector Setup, click **Download Now**.
- 4 In the File Download dialog box, click **Run**.
- 5 Follow all onscreen installation instructions until you finish installation.

# Connect to the Home Server Console

In order to remotely administer the home server, you need to log onto the Windows Home Server Console.



.....  
**Note:** Make sure you have the administrator password to the home server.

There are three ways to launch Windows Home Server Console - Windows Start menu, double-clicking the Windows Home Server icon, or right-clicking the Windows Home Server icon.

To log onto the home server using Windows Start menu:

- 1 On your computer, click **Start > Programs > Windows Home Server Console**.

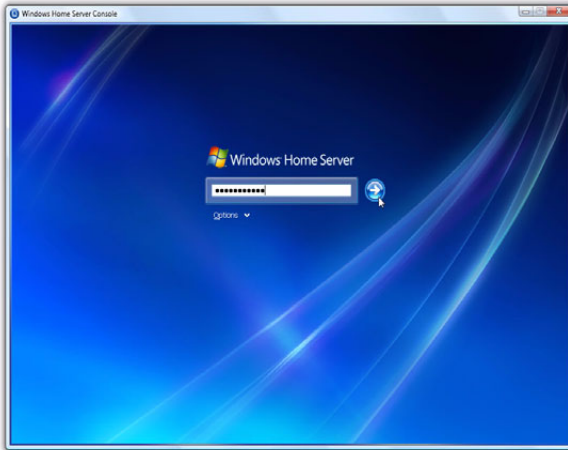

- 2 Enter the administrator password, then click the **Next** arrow.



To log onto the home server using Windows Home Server icon:

- 1 Right-click on the **Windows Home Server** icon  in the system tray, then select **Windows Home Server Console** from the pop-up menu.

Or,

Double-click the **Windows Home Server** icon  in the system tray.

- 2 Enter the administrator password, then click the **Next** arrow.



# 3 Windows Home Server Console

The Windows Home Server Console is a tool that provides remote management of the home server and allows you to monitor and backup computers on the home network. It allows you to remotely administer your home server from anywhere on the home network. Once logged in, you can monitor the health of the home server and connected computers on the network, create backup schedules connected to the computers, backup computers, and manage user accounts, shared folders on the server.

Windows Home Server Console provides access to the following tabs:

- Computers and Backup
- User Accounts
- Shared Folders
- Server Storage
- Lights Out
- McAfee Total Protection
- System Information
- Network Health
- Settings

To learn more about configuring the Windows Home Server, click Help on the console to open the Windows Home Server Console Help.

# Computers & Backup

You can use the Computers & Backup tab on the Windows Home Server Console to view the home computers connected to the home server and monitor the health status of the home computers and administer backups. After you install Windows Home Server Connector on each of your home computers, they are automatically backed up on each night to your home server.

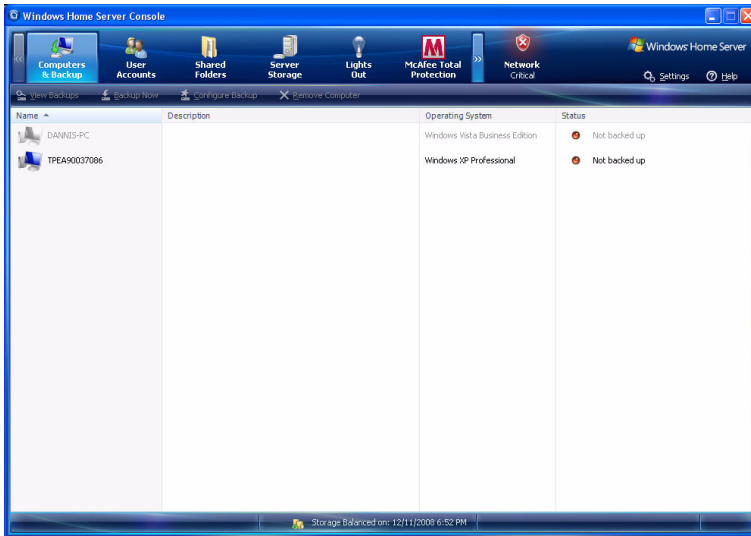

The options on the Computers & Backup tab allow you to:

- View Backups - Browse the existing backups of a home computer.
- Backup Now - Initiate manual backup of a home computer.
- Configure Backup - Change the backup settings of a home computer.
- Remove Computer - Delete computer and backups from the home server.

For more information, see Computers & Backup in the Windows Home Server Console Help.

# User Accounts

You can use the User Accounts tab on the Windows Home Server Console to create a personal user account, enable a guest account, and maintain user accounts on the home server.

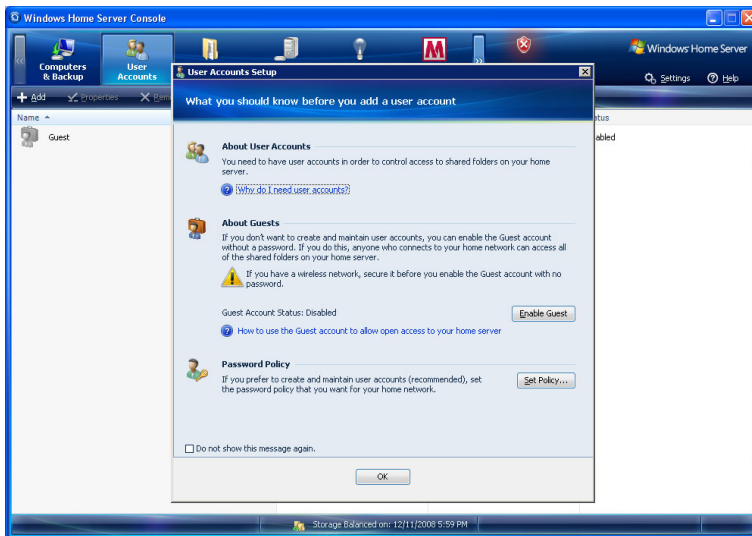

The options on the User Accounts tab allow you to:

- Add - Create a new user account on the home server and set access rights for the user.
- Properties - View and change user account properties.
- Remove - Delete a user account from the home server.

For more information, see User Accounts in the Windows Home Server Console Help.

# Shared Folders

You can use the Shared Folders tab on the Windows Home Server Console to add, open, remove, and view shared folders on the home server. With Shared Folders you can centrally store files on your home server so that you can share with other people on your home network.

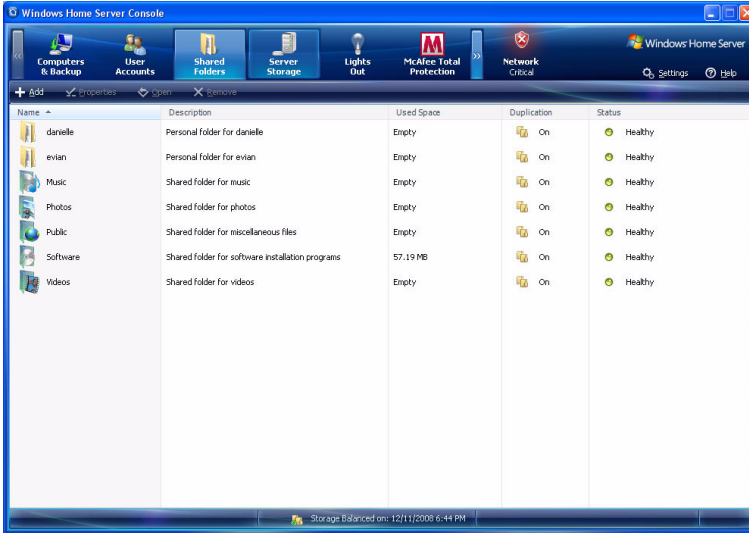

The following shared folders are created automatically on the home server:

- Music
- Photos
- Public
- Software
- Videos
- A personal shared folder for each personal user account that is added. By default, no other user account can access this personal shared folder

The options on the Shared Folders tab allow you to:

- Add - Create a new shared folder on the home server.
- Properties - View and change shared folder properties.
- Open - Browse files and folders in the shared folder.
- Remove - Delete an existing folder from the home server.

For more information, see Shared Folders in the Windows Home Server Console Help.

# Server Storage

The Server Storage tab on the Windows Home Server Console displays all the hard drives installed on your home server. You can use Server Storage to view, add, repair, and remove hard drives from the home server.

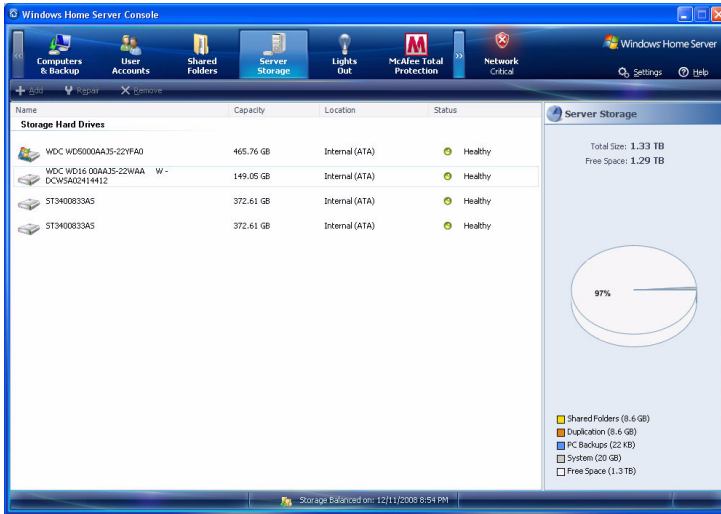

The options on the Server Storage tab allow you to:

- **Add** - You can add hard drives of various sizes to the home server and set the hard drives for the following usage:
  - **Server storage** - This option gives you more space to store home computer backups and more space for your shared folders.
  - **Server Backup** - This option allows you to backup all your home server shared folders. If you use an external hard drive for your home server backups, you can store the hard drive in a separate location. When you select this option, your home server appears in the Computers & Backup tab. You can use Backup Now to back up your shared folders to the hard drive.
- **Repair** - Fix errors on an unhealthy hard drive.
- **Remove** - Delete a hard drive from the home server.

For more information, see Server Storage in the Windows Home Server Console Help.



# Lights Out

Lights Out is a power management add-in software that allows you to set the home server into suspend mode or wake the system at a chosen time with the aid of a calendar event.



The Lights Out tab include the following options:

- Refresh - Ensures you have the most recent version of the uptime diagram.
- Update diagram - Displays a chart showing recorded uptimes in the home server, such as when a backup took place, which home computer was active, or when the home server woke up from sleep mode.
- Calendar - Displays the calendar window and allows you to add, edit, delete a calendar entry.
- Settings - Displays the Windows Home Server Settings dialog box. For more information on how to configure the Lights Out settings, see page 57.
- About - Displays version number and copyright information.

For more information, click Help in the Lights Out window.

# McAfee Total Protection

McAfee Total Protection is an add-in software for Windows Home Server. It is a comprehensive security management solution that checks for viruses, spyware, unwanted programs, and other potential threats on the home server.

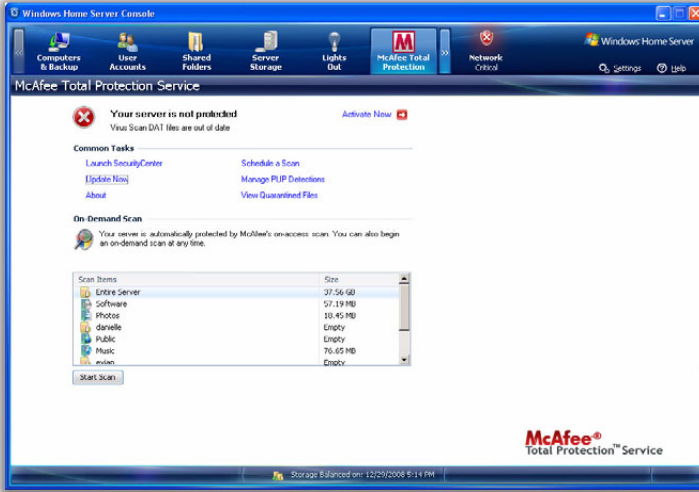

**Note:** Before you can schedule a scan or have the home server virus pattern updated, you must activate the McAfee Total Protection Service

You can perform the following tasks in the McAfee Total Protection tab:

- Launch SecurityCenter
- Update Now
- About
- Schedule a Scan
- Manage PUP Detections
- View Quarantined Files

For more information, click Help in the McAfee Total Protection window.

# System Information

The System Information tab on the Windows Home Server Console provides an all around monitoring mechanism to help you keep an eye on the home server's health and performance details.

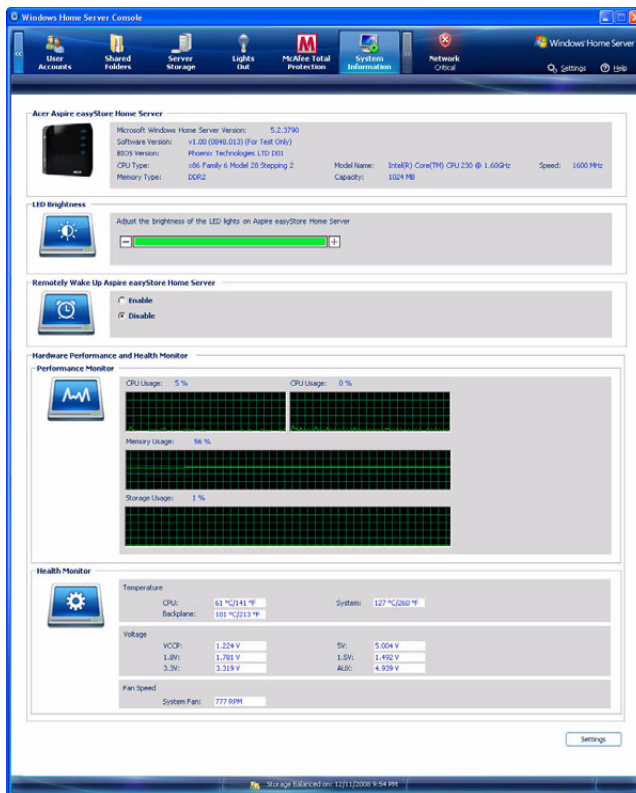

System Information supports the following features:

- Acer Aspire easyStore Home Server - Displays basic information about the home server, such as the specification of the processor and memory currently installed in the home server, BIOS version, and operating system version.
- LED Brightness - Allows you to adjust the brightness of the LED indicators on the home server.

- Remotely Wake Up Aspire easyStore Home Server - Allows you to enable or disable remote wakeup feature.
- Hardware Performance and Health Monitor - Allows you to view the performance data of the home server, and monitor the temperature, voltage and fan speed.

To adjust the LED brightness of the home server:

On the LED Brightness field, drag the slider in a horizontal manner to a desired position.

To enable or disable the remote wake up feature:

- 1 On the Remotely Wake Up Aspire easyStore Home Server field, click the "Enable" check box to wake the home server from sleep mode. It allows users, who want to upload files, to wake the system from sleep mode.
- 2 Click the "Disable" check box to disable this feature.

For more information, refer to Network Health in the Windows Home Server Console Help.

# Network Health

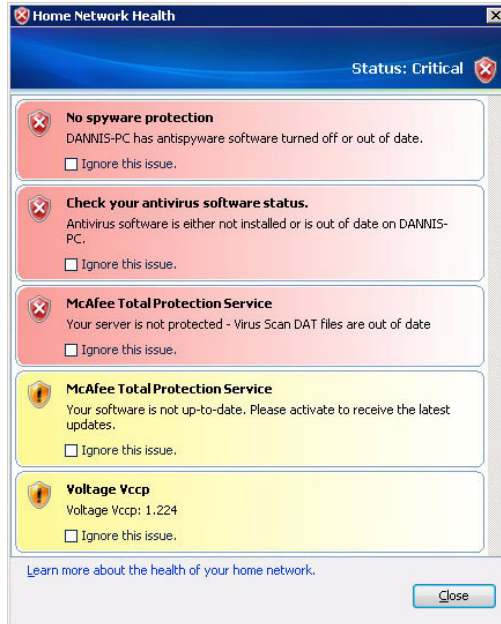

The Network Health tab displays health notifications from your home server and your home computers. You can view the health of your entire network from one convenient location so you can take the necessary actions to correct any problems.



**Note:** Health notifications are also displayed in the Windows Home Server icon on home computers that have the Windows Home Server Connector software installed.

The possible health states are as follows:

Color	Status
	Indicates a healthy network.

Color	Status
	Indicates an at risk issue that you must attend soon.
	Indicates a critical issue that you must attend to immediately.

---

For more information, right-click the Windows Home Server icon, click Help.

# Settings

The Settings button on the upper right hand corner of the Windows Home Server Console window allows you to configure your home server settings. The Settings window provides a variety of administrative options.

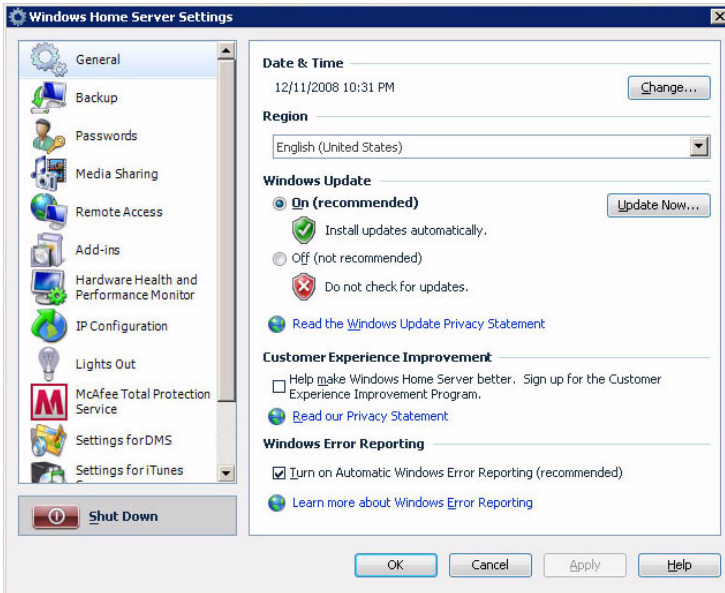

In the Settings window you can configure the settings for the following categories:

- General
- Backup
- Passwords
- Media Sharing
- Remote Access
- Add-ins
- Hardware Health and Performance Monitor
- IP Configuration
- Lights Out
- McAfee Total Protection Service

- Settings for DMS
- Settings for iTunes Server
- Resources

## General

The General settings page allows you to modify the date and time, language selection, Windows Update settings, Customer Experience Improvement program, and enable or disable Windows error reporting.

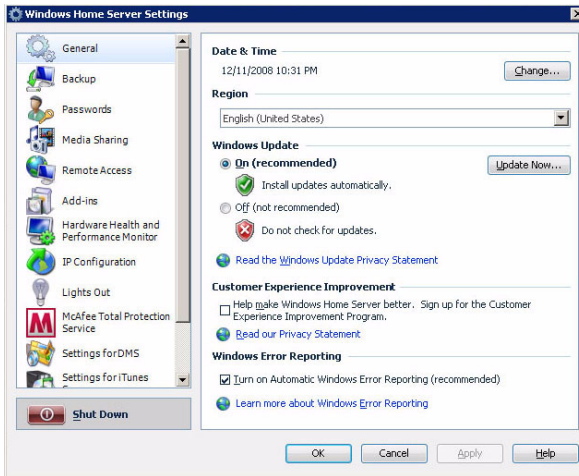

For information about the tasks that you can perform on the General settings page, click the Help button on the lower right hand corner of the General page.



## Backup

The Backup settings page allows you to configure the start and end time for backing up computers on the home network, specify the number of months, weeks, and days to keep backups on the home server, and manually clean up old backups.

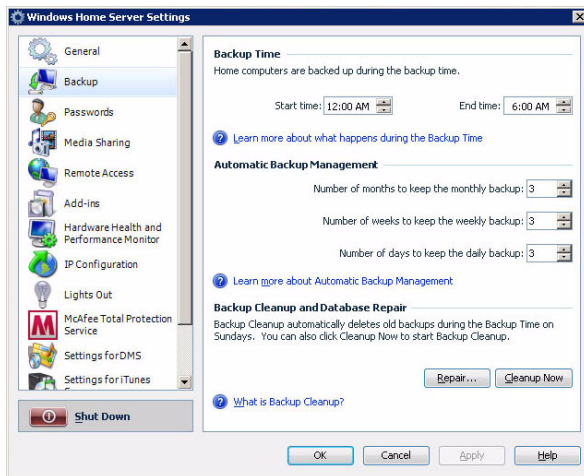

For information about the tasks that you can perform on the Backup settings page, click the Help button on the lower right hand corner of the Backup page.

# Passwords

Use the Password settings page to change the home server password and modify the user accounts password policy.

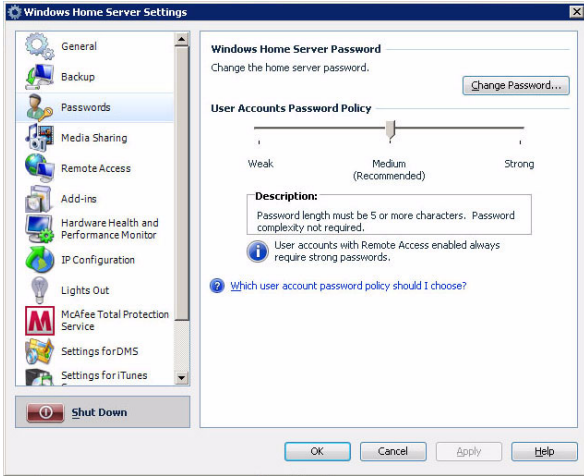

For more information, click the Help button on the lower right hand corner of the Passwords page.

# Media Sharing

The Media Sharing settings page allows you to enable or disable Windows Home Server sharing capabilities.

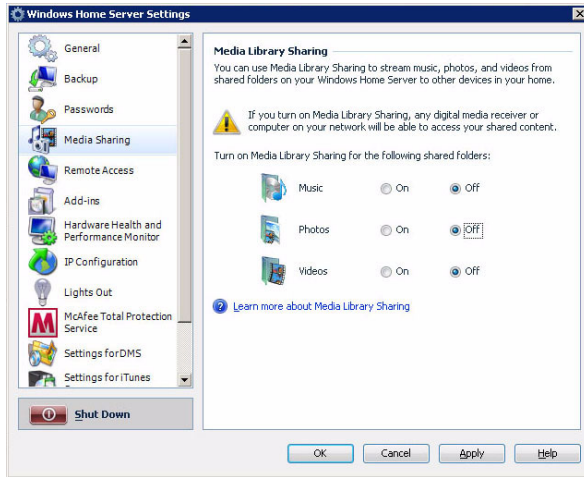

For information, click the Help button on the lower right hand corner of the Media Sharing page.

## Remote Access

The Remote Access settings page helps you configure everything you need to access the Aspire easyStore H340 home page from the Internet. To get remote access up and running, you must turn on Web Site Connectivity, configure your router, configure a domain name for your home server, and set the Aspire easyStore H340 home page.

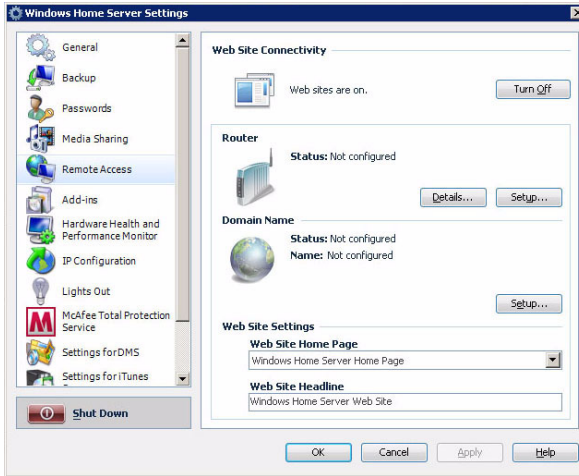

For more information, click the Help button on the lower right hand corner of the Remote Access page.

## Add-ins

The Add-ins settings page allows you to configure the add-in software that you have installed or want to install on your home server.

For information on how to install an add-ins, click the Help button on the lower right hand corner of the Add-ins page.

## Hardware Health and Performance Monitor

Use the Hardware Health and Performance Monitor settings page to set a refresh interval for monitoring data, configure performance threshold settings, specify email destinations to which alerts should be sent when temperature, voltage, and fan speed abnormality is detected or the pre-configured threshold is exceeded.

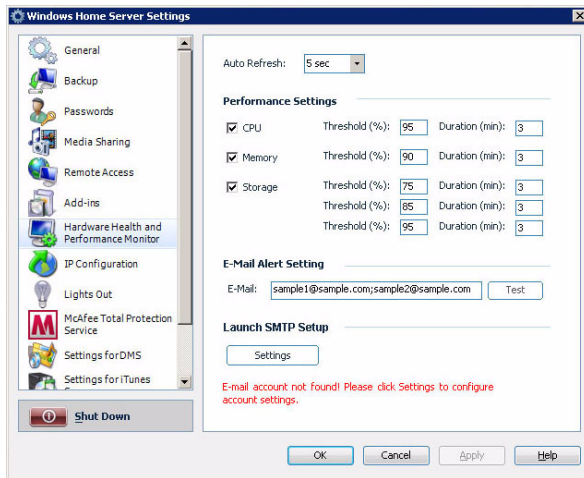

In the Hardware Health and Performance Monitor page, you can configure the following settings:

- **Auto Refresh** - Sets the refresh interval to tell Windows Home Server how frequent the monitoring data should be performed.
- **Performance settings** - Sets the performance threshold of the CPU, Memory and Storage.
- **E-Mail alert setting** - Specify an email address to which alerts should be sent.
- **Launch SMTP setup** - Configure the Simple Mail Transport setup.

To validate the email alert feature, it is required that you properly configure email destinations and SMTP setup. Refer to "Set up email alerts" on page 100 for more details.

For more information, click the Help button on the lower right hand corner of the Hardware Health and Performance Monitor page.

## IP Configuration

The IP Configuration settings page allows you to view the home server's current IP configuration settings or change the IP configuration manually.

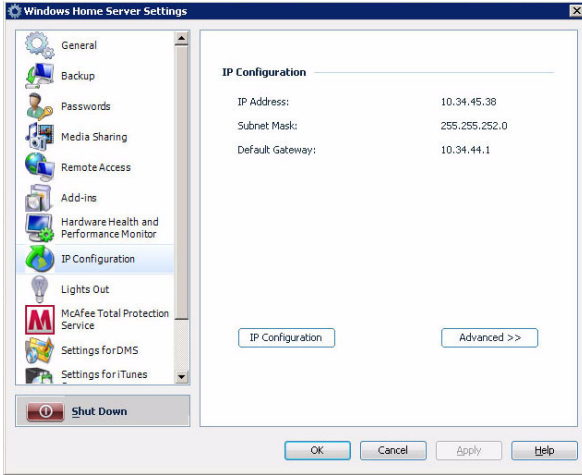

For more information, click the Help button on the lower right hand corner of the IP Configuration page.

## Lights Out

Use the Lights Out page to define times where the home server has to go to suspend or resume mode.

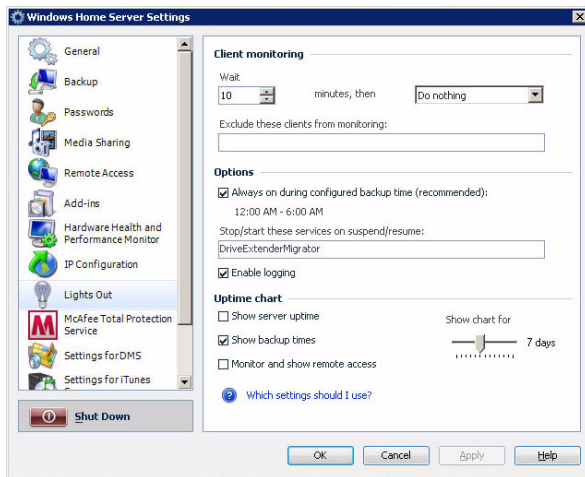

In the Lights Out page, you can configure the following settings:

- **Client computer monitoring** - Client computer monitoring is used to check periodically for active clients. When no active clients are detected, the selected action will be executed after the wait time. You can choose to disable client monitoring, put your server to suspend or hibernate mode, or shut down the server.
- **Options** - You can set Lights Out to wake up your home server on a configured backup time. You should enable this option when you run regular backups.
- **Uptime diagram** - Recorded uptimes are visualized in the uptime chart. You can choose between a history range of 2 to 14 days. When your server is always up, you can exclude the server from the chart. In the same way you can configure the display of backup times.

When the monitoring for remote access is enabled, the default action is disabled as long as a remote user is logged in. The default timeout from the home server is set to 20 minutes. Lights Out waits 3 additional minutes after timeout.

For more information, click the Help button on the lower right hand corner of the Lights Out page.

# McAfee Total Protection Service

Use the McAfee Total Protection Service page to manage security for your home server.

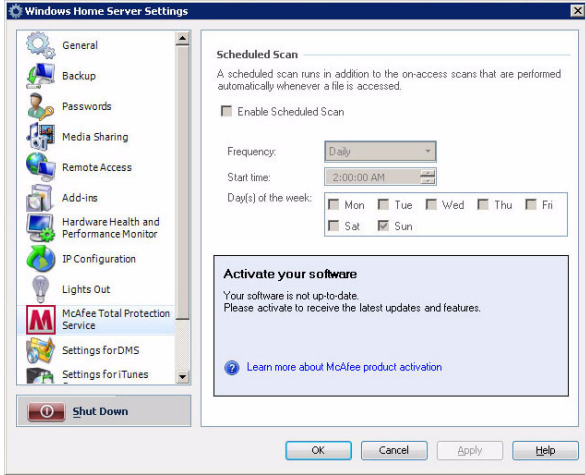

For more information, click the Help button on the lower right hand corner of the McAfee Total Protection Service page.



## Settings for DMS

The Settings for DMS (Digital Media Server) page allows you to enable or disable digital media server function and customize the sorting method of photos and videos.

With DMS enabled, digital media controllers and digital media players using UPnP (Universal Plug'n Play) protocol, will automatically discover, access, and play media files on the home server. It also makes possible for iTunes, PS3, or Xbox 360 users to share media files on Windows Home Server.

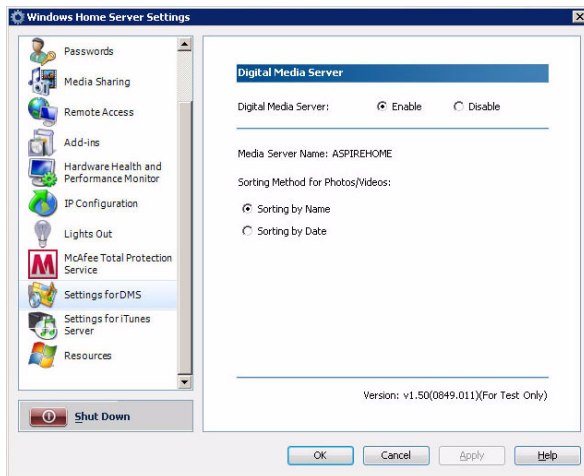

In the Settings for DMS, you can configure the following settings:

- Digital Media Server - Enables or disables the digital media server.
- Sorting method - Select a sorting method to organize digital files under the photos or videos shared folders.

For more information, click the Help button on the lower right hand corner of the Settings for DMS page.

## Settings for iTunes Server

The Settings for iTunes Server page allows you to enable or disable the iTunes server function, specify how often the music library is updated, set a password to secure the iTunes Server access.

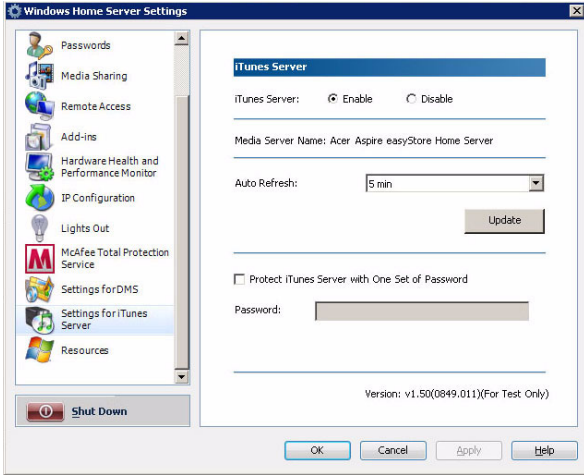

For more information, click the Help button on the lower right hand corner of the Settings for iTunes Server page.

## Resources

You can use the Resources page to view the following information about your home server:

- Microsoft Windows - Activates Windows Home Server and allows you to view the Microsoft Software License Terms.
- Home Server - Displays information about your home server hardware.
- Version Information - Displays the version of the Windows Home Server services that are running on your home server.
- Learn More - Displays additional Windows Home Server links.
- Support - Displays the Product Support link.

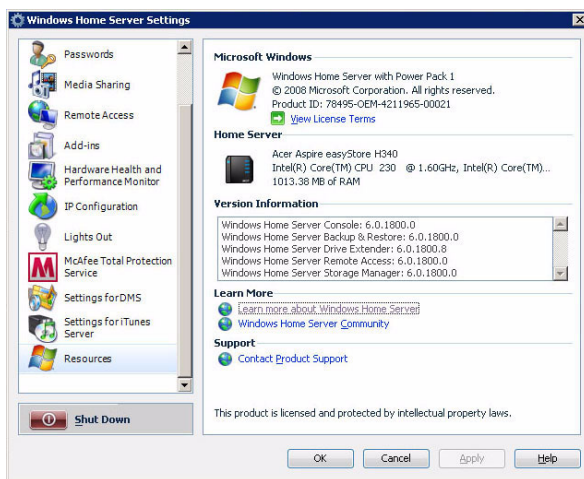

## Shut Down

The Shut Down button on the left pane allows you to shut down Windows Home Server so that you can safely turn off power or start Windows Home Server again.



# 4 Managing the server

After you complete the Windows Home Server Setup and install the Windows Home Server Connector software on all of your home computers, you can now perform the following tasks:

- Create user accounts
- Add a shared folder
- Configure backup for home computers
- Back up the home server
- Configure the home server for remote access
- Access the Aspire easyStore H340 home page
- Access the shared folders on the home server
- Enable media sharing
- Enable Digital Media Server
- Enable iTunes service
- Stream audio
- Using the one-touch USB backup feature
- Set up Wake On LAN on the home server
- Set the home server uptime and down time
- Monitor server health and performance
- Set up email alerts
- Explore the Windows Home Server icon

To learn more about using the Windows Home Server Console to configure the home server, refer to “3 Windows Home Server Console” on page 37.

# Create user accounts

After you complete Windows Home Server Setup and install the Windows Home Server Connector software on all of your home computers, you are ready to set up your user accounts for the people in your household.

There are two types of user accounts that you can set up for the home server:

- Guest account - If you want everybody to use the same user account to access the home server, you must enable the guest account feature in the console.
- Personal user account - If you want an individual to access the home server with their own personal user account, you must add matching user accounts on Windows Home Server and give access privileges to individual shared folders.

To enable the guest account:

The guest account can be used to give access to shared folders for users that do not have their own user account for Windows Home Server. Enabling the guest account will provide default Read permission to the shared folders: Music, Photos, Videos, Public, and Software.



-----  
**Caution:** If you enable the guest account, your home server is open to anyone who connects to your home network. They can access all of the shared folders and other resources on your home server.

- 1 Double-click the **Windows Home Server** icon  in the system tray.
- 2 Log on to the **Windows Home Server Console**.

- 3 Click the **User Accounts** tab.

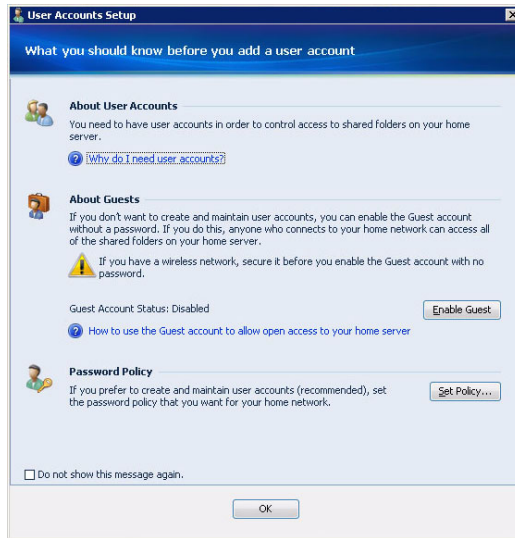

- 4 Under **About Guests**, click **Enable Guest**.



-----  
**Caution:** If you have a wireless network, secure it before you enable the guest account with no password. For more information, see the documentation for your wireless device.

- 5 Click **OK**.

To add a personal user account:



**Note:** A personal shared folder is created each time you add a new user account. By default, only this user account has access to the personal shared folder. Users can store personal files in this personal shared folder.

- 1 Double-click the **Windows Home Server** icon  in the system tray.
- 2 Log on to the **Windows Home Server Console**.
- 3 Click the **User Accounts** tab.
- 4 Click **Add**.
- 5 On the User Accounts Setup window, click **Set Policy** to set a user accounts password policy.

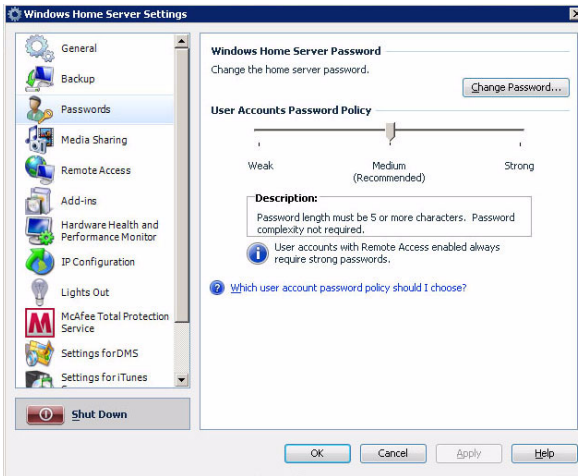

- 6 Click **OK**.



7 Click **Add**.

## 8 Enter the user's name.



**Note:** When you create user accounts on Windows Home Server, use logon names that match the logon names of your existing user accounts on your home computers. Also, use the same password that you use for your existing user accounts. If the user accounts and passwords do not match, you will be prompted for a user name and a password when you open the Shared folders.

## 9 Select the “Enable Remote Access for this user” check box if you want to allow the user to remotely access the home server.

10 Click **Next**.

- 11 Enter a password which must be at least 7 characters, then re-enter it in the Confirm password field.
- 12 Click **Next**.

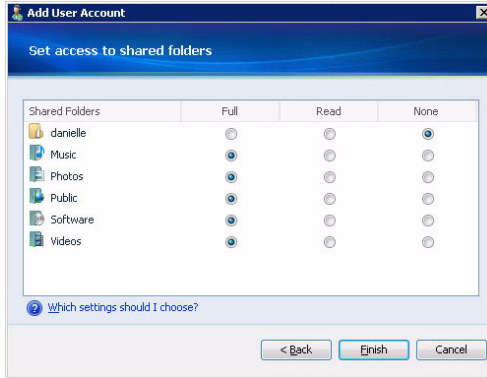

- 13 Assign user rights to the shared folders on the home server.
  - Full - The user can view, add, modify, and delete files in the shared folder.
  - Read - The user can view files in the shared folder, but cannot add, modify, or delete files.
  - None - The user cannot view, add, modify, or delete files in the shared folder.
- 14 Click **Finish**.
- 15 Click **Done** to exit the wizard.

# Add a shared folder

Shared folders are places for you to organize and store files on the home server so that you can share them with other people on your home network.

- 1 Double-click the **Windows Home Server** icon  in the system tray.
- 2 Log on to the **Windows Home Server Console**.
- 3 Click the **Shared Folders** tab.
- 4 Click **Add**.

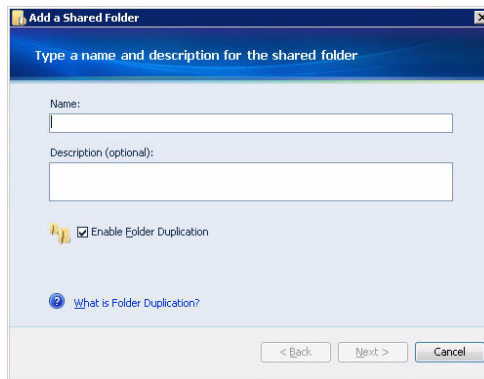

- 5 Enter a name and description for the shared folder.
- 6 Select the “Enable Folder Duplication” check box if you want folders and files in the share folder to be duplicated across multiple hard drives.



.....

**Note:** The home server must have more than one hard drive added to the server storage before you can enable Folder Duplication and there must be enough storage space available for duplication to take place.

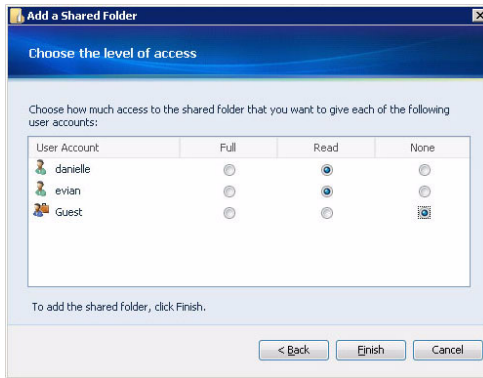
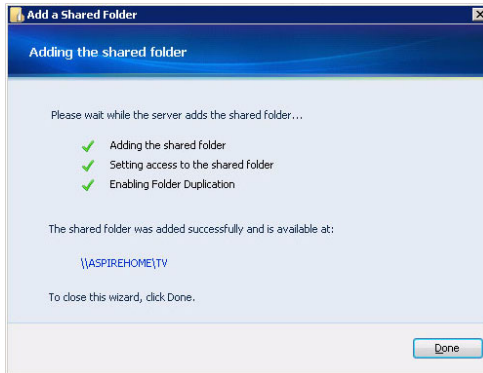
7 Click **Next**.8 Assign user rights to the new share folder, then click **Finish**.9 Click **Done** to exit the wizard.

# Configure backup for home computers

You can customize the backup of each of your home computers from the Windows Home Server Console.



**Note:** After you install the Windows Home Server Connector to the home computer all hard drive volumes on the home computer are automatically backed up each night.

To configure backup for a computer:

- 1 Double-click the **Windows Home Server** icon  in the system tray.
- 2 Log on to the **Windows Home Server Console**.
- 3 Click the **Computers & Backup** tab.

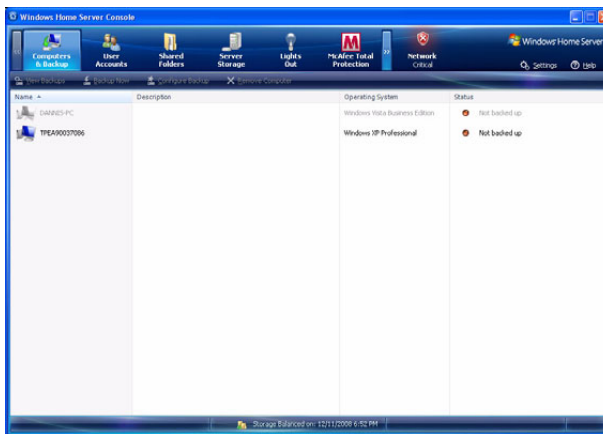

- 4 Complete the Backup Configuration Wizard to choose the volumes you want to back up and the folders you want to exclude from the backup.

You can adjust the period of time when automatic backups and maintenance are performed. The period of time that you choose should be a time when your home computers are normally not being used. The time period must be a least one hour long and can be up to 23 hours long. The default settings are Start Time: 12:00 AM and End Time: 6:00 AM.

# Back up the home server

You can back up your home server to ensure that you have backup copies of important files that are located in your Windows Home Server shared folders and application folders. You can add hard drives to your home server to use for server backups by using the **Server Storage** tab.

To back up the home server:

- 1 Install a new hard drive to the home server. See step 1 of “Adding a hard disk drive” on page 107.
- 2 Double-click the **Windows Home Server** icon  in the system tray.
- 3 Log on to the **Windows Home Server Console**.
- 4 Click the **Server Storage** tab.

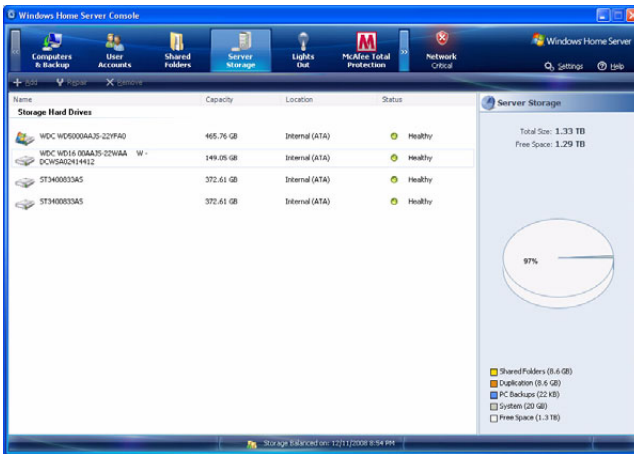

- 5 Select the newly installed hard drive (either internal or external), then click **Add** to run the Add a Hard Drive Wizard.

6 Click **Next**.

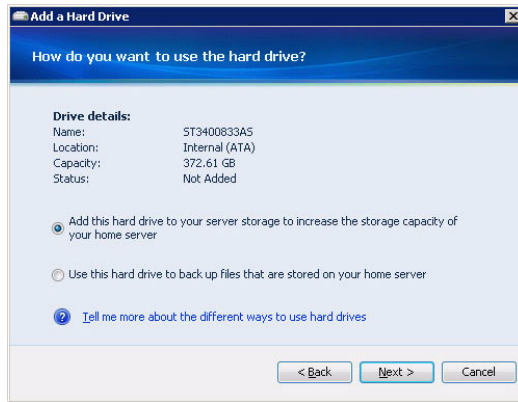

7 Select the "Use this hard drive to back up files that are stored on your home server" option button.

8 Click **Next**.

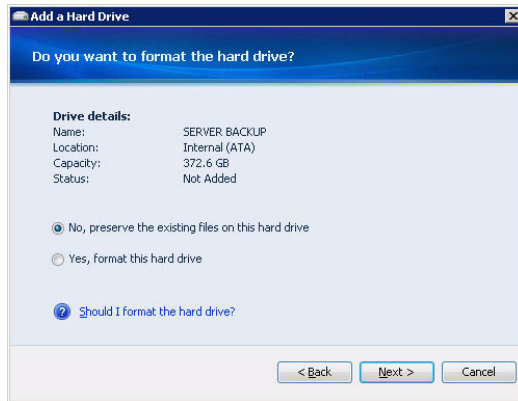

- 9 Select if you want to preserve or format the hard drive, then click **Next**.



- 10 Enter a name for the hard drive, then click **Next**.



.....  
**Note:** You can write this name on a label and attach it to your hard drive to help you identify it later.

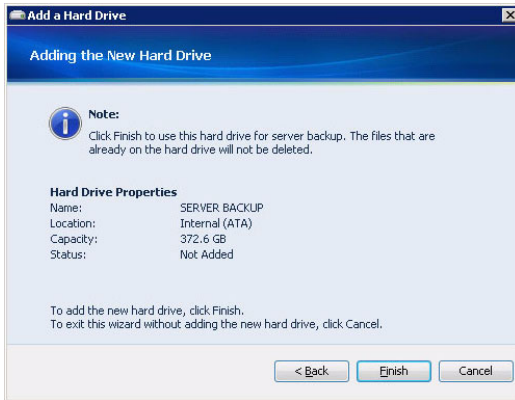

- 11 Click **Finish**.



12 Click **Done**.

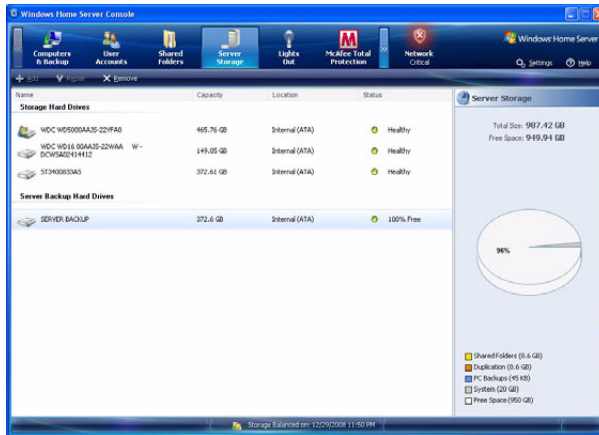

- 13 Click the **Computers & Backup** tab.
- 14 Select the Server Backup Hard Drive you want to use to back up your shared folders and application folders.
- 15 Click **Backup Now**.
- 16 Select a destination hard drive for each shared folder.
- 17 Click **Backup Now**.
- 18 Click **Close**.

# Configure the home server for remote access

You must configure your home server for remote access to easily access your files and home computers from anywhere with an Internet connection. You can download files, upload files, connect to your home computers, and administer the home server.

To configure the home server for remote access:



**Important:** Only personal user accounts with remote access permissions can log on to the Aspire easyStore H340 home page.

- 1 Double-click the **Windows Home Server** icon  in the system tray.
- 2 Log on to the **Windows Home Server Console**.
- 3 Click **Settings**.
- 4 In the navigation pane, select **RemoteAccess**.

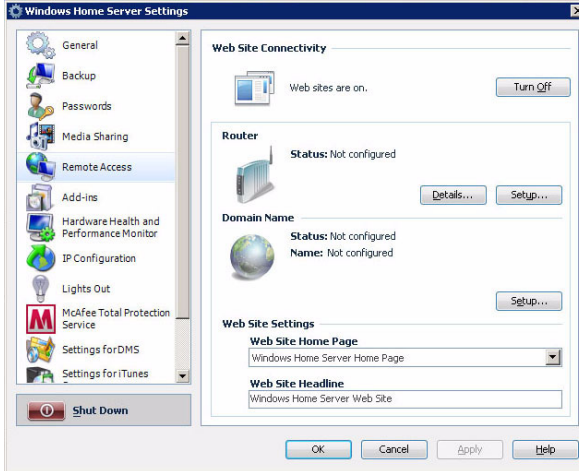

- 5 Under Web Site Connectivity, click **Turn On** to allow remote connection to the home server.
- 6 Under Router, click **Setup** to configure your broadband router. Make sure your router supports UPnP standards and the UPnP

setting must be enabled on your router for Windows Home Server to automatically configure it.

In this step, Windows Home Server configures the persistent port forwarding from your UPnP certified router to your home server, as follows:

- Port 80 - Connects over your home network to the Aspire easyStore H340 home page using the HTTP protocol.
- Port 443 - Connects over your home network to the Aspire easyStore H340 logon page using HTTPS, an encrypted Secure Sockets Layer protocol.
- Port 4125 - Connects to your home computers via the remote desktop proxy.



.....

**Note:** To learn more about router configuration, click **Help** on the Remote Access page.

- 7 Under Domain Name, click **Setup** to set a personalized domain name for your home server (For example, smithfamily.homeserver.com).

A domain name uniquely identifies your home server on the Internet. It is used to connect to your home server while you are away from home. Even if your Internet IP address changes, you can still connect to your home network with your personalized domain name. For example, you could register the name smithfamily.homeserver.com and then use that name to connect to your Aspire easyStore H340 Web site.



.....

**Note:** You need a Windows Live ID to set up a domain name for your home server.

- 8 Click **Next**.
- 9 Enter your Windows Live ID email address and password to begin setting up the domain name.

Windows Home Server includes a built-in dynamic DNS client feature that binds your personalized domain name to the external IP address that is assigned by your ISP (Internet service provider).

- 10 Click **Next**.
- 11 Click the "I accept" option, then click **Next**.

- 12 Enter the domain name and select a subdomain name.
- 13 Click **Confirm** to make sure the subdomain is available.
- 14 Click **Finish**.
- 15 Under Web Site Settings, you can choose a default home page and the Web site headline that appears on the Aspire easyStore H340 Web page.
- 16 Click **OK**.
- 17 After you configure remote access, test the remote connectivity from outside of your home. Refer to "Access the Aspire easyStore H340 home page" on page 79.

# Access the Aspire easyStore H340 home page

After you configure a user account for remote access, you can use a Web browser on a computer that is outside your home to remotely access your home server and home computer.

On the Aspire easyStore H340 home page, you can perform the following:

- Remotely access the Windows Home Server Console.
- Remotely access your home computers
- Remotely download or upload files to shared folders



.....

**Important:** Use Internet Explorer to access and remotely administer your home server over the Web. Some features, such as accessing the home computers or the Windows Home Server Console, is not available when you use other Web browsers.

To access the Aspire easyStore H340 home page:



.....

**Note:** You cannot use the guest or administrator account to access the home page. You must log on with a personal user account that is enabled for Remote Access.

- 1 Make sure the home server is configured for remote access. See “Configure the home server for remote access” on page 76.



.....

**Note:** You may need to add services from your broadband provider to use the remote access features in Windows Home Server. For more information, refer to the Windows Home Server Console Help.

- 2 Open the Internet Explorer Web browser.
- 3 Enter the Internet domain name assigned to you during the remote access setup procedures. For example `https://SmithFamily.HomeServer.com.`, where `SmithFamily.HomeServer` is the domain name that is assigned to the home server.
- 4 Click **Log On** on the upper right hand corner.

- 5 Enter your home server user name and password.
- 6 Click **Log On**.

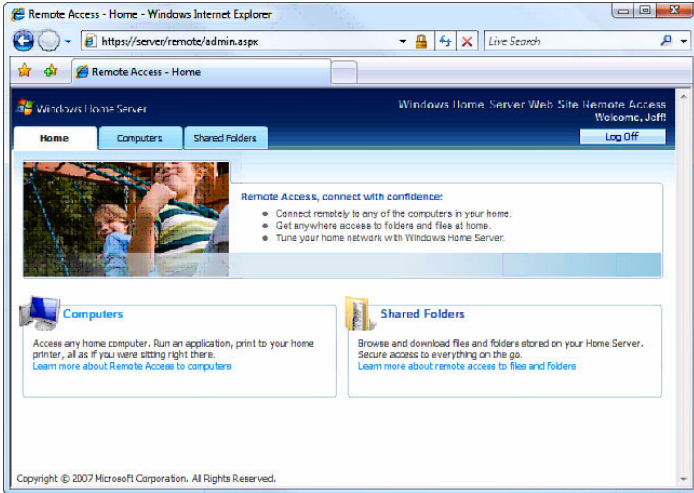

The home page include three tabs:

- Home - This page appears every time you log on to the Web page.
- Computers - Allows you to perform remote administration on the home server and the home computers.

To access your home server, click **Connect to your Home Server** on the Computers tab and enter the administrator password. The Windows Home Server Console interface displays.

To access your home computers, click the **name of the home computer** under the Remote Access to Computers field on the Computers tab.



.....  
**Note:** Make sure that the home computer is configured to allow remote access. For detailed instructions about how to complete this configuration, see "Can't connect to some computers on the Aspire easyStore H340 Remote Access page" on page 133.

- Shared Folders - Allows you to access the shared folders you have access privileges over the Internet.

# Access the shared folders on the home server

There are several ways you can access your shared folders on the home server.

To access the shared folders using the desktop shortcut:

- 1 Double-click the **Shared Folders** desktop shortcut  to see the shared folders that are on your home server.

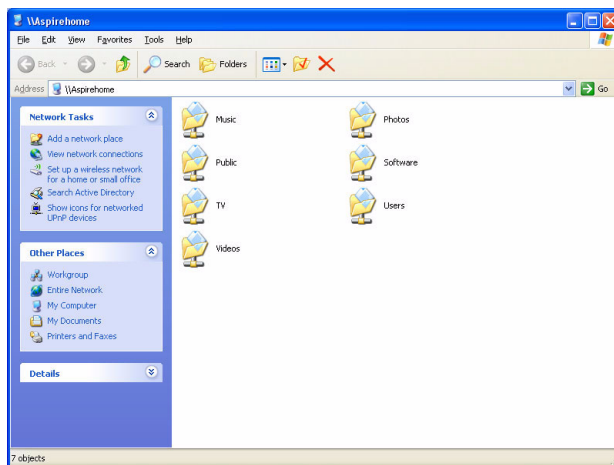

- 2 Double-click a shared folder to open it.

To access the shared folders using the Windows Home Server icon:

- 1 Right-click the **Windows Home Server** icon .

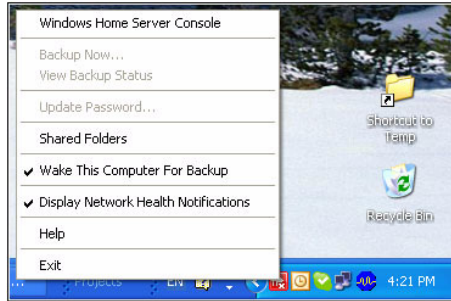

- 2 Click **Shared Folders**.
- 3 Double-click a shared folder in the window to open it.

To access the shared folders using the Windows Start Menu:

- In Windows Vista, click **Start**, then type \\homeservername in the Start Search text box, where the homeservername (i.e. Aspirehome) is the name of your home server. Double-click a shared folder in the window to open it.
- In Windows XP, click **Start**, click **Run**, and then type \\homeservername in the Open text box, where the homeservername (i.e. Aspirehome) is the name of your home server. Double-click a shared folder in the window to open it.

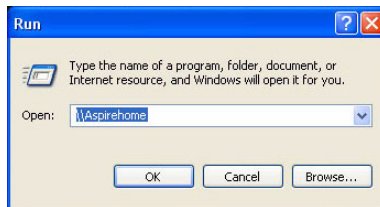



To access the shared folders using the Internet:

- 1 Log on to the Aspire easyStore H340 home page. See "Access the Aspire easyStore H340 home page" on page 79.
- 2 Click the Shared Folders tab.

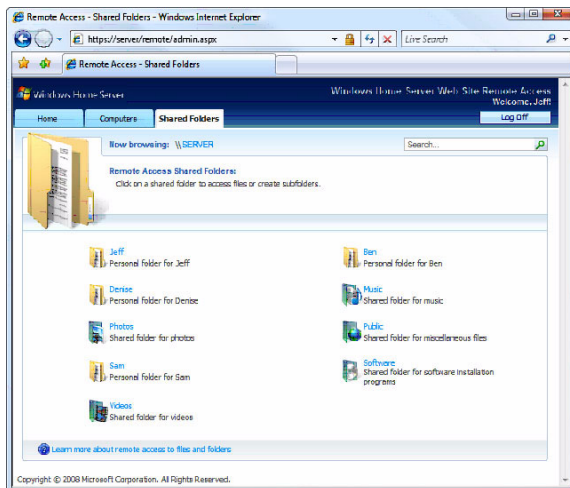

- 3 You can navigate to a particular shared folder, then download or upload files to your home server.

# Enable media sharing

The Windows Home Server allows you to stream music, photos, and videos from the home server to any supported digital media receiver, such as an Xbox 360, or to a supported digital media player, such as Windows Media Player 11.

To enable media sharing:

- 1 Double-click the **Windows Home Server** icon  in the system tray.
- 2 Log on to the **Windows Home Server Console**.
- 3 Click **Settings**.
- 4 In the navigation pane, select **Media Sharing**.

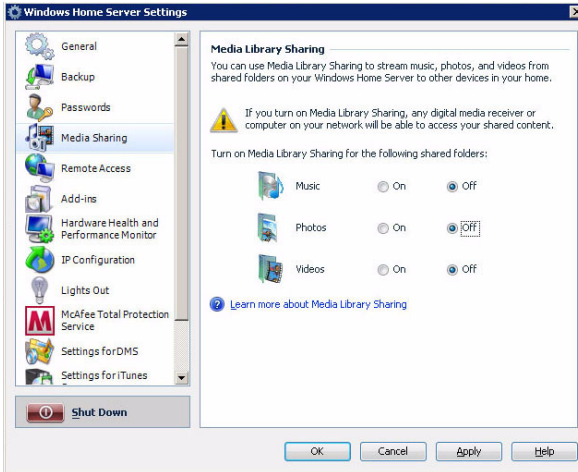

- 5 Select a folder, then click **On**.
- 6 Click **OK**.

# Enable Digital Media Server

The Digital Media Server feature allows you to browse, access and play media contents on the home server. It makes possible for iTunes and Xbox 360 users to share media files on the home server.

The home server supports the following digital media files:

- Music: MP3, WMA, WAV, AAC, AC3, FLAC, APE, OGG, VOC, AIFF, AU, MID
- Video: WMV, ASF, MOV, AVI, MPEG, 3GP, SWF, FLV, RMVB, RM, RA, RAM, MP4, MPG, MPE, M2V, TP, TS, MLV, MKV, DIVX
- Photos: GIF, PNG, BMP, JPG, JPEG, ICO, TIFF, DXF, WMF, EMF, PICT, EPS, CDR

To enable digital media server:

- 1 Double-click the **Windows Home Server** icon  in the system tray.
- 2 Log on to the **Windows Home Server Console**.
- 3 Click **Settings**.
- 4 In the navigation pane, select **Settings for DMS**.

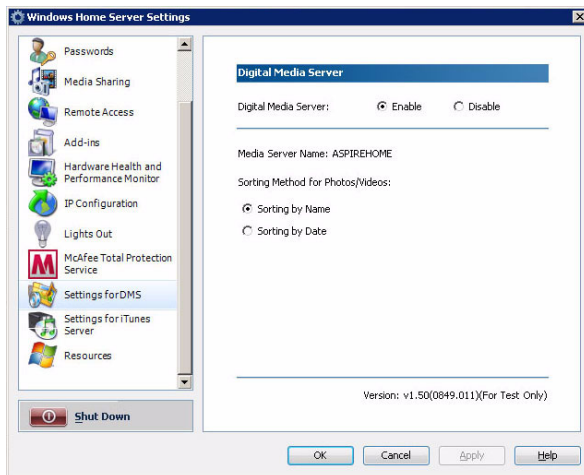

- 5 Under Digital Media Server, click the "Enable" option button.

- 6 Select a sorting method for the Photos and Videos shared folders.
  - Sorting by Name - Photos and videos are arranged according to the original organization, which is the default option.
  - Sorting by Date - Digital Media Server auto checks the latest modification dates of files and creates different virtual folders by year and subfolders by month.
- 7 Click **OK**.

# Enable iTunes service

The Digital Media Server feature allows you to enable or disable the iTunes server function, specify how often the music library is updated, set a password to secure the iTunes Server access.

To enable iTunes service:

- 1 Double-click the **Windows Home Server** icon  in the system tray.
- 2 Log on to the **Windows Home Server Console**.
- 3 Click **Settings**.
- 4 In the navigation pane, select **Settings for iTunes Service**.

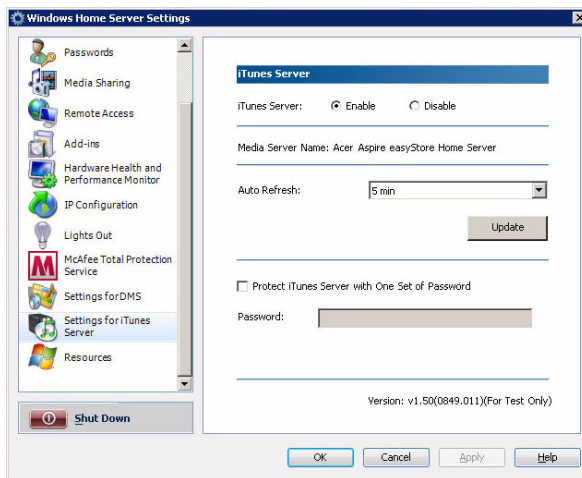

- 5 Under iTunes Server, click the "Enable" option button.
- 6 Specify how often iTunes can scan the home server for new music files.
- 7 Enter a password to protect iTunes server.
- 8 Click **OK**.

# Stream audio

You can use Windows Media Player 11 or iTunes to play music files stored on the home server to your computer.

To stream audio in Windows Media Player 11:

- 1 Make sure that media sharing is enabled. Refer to “Enable media sharing” on page 84 for more information.
- 2 Make sure Digital Media Server is enabled. Refer to “Enable Digital Media Server” on page 85 for more information.
- 3 Open the Windows Media Player.



- 4 Click the **Library** tab. The Acer Aspire easyStore H340 appears in the navigation pane.

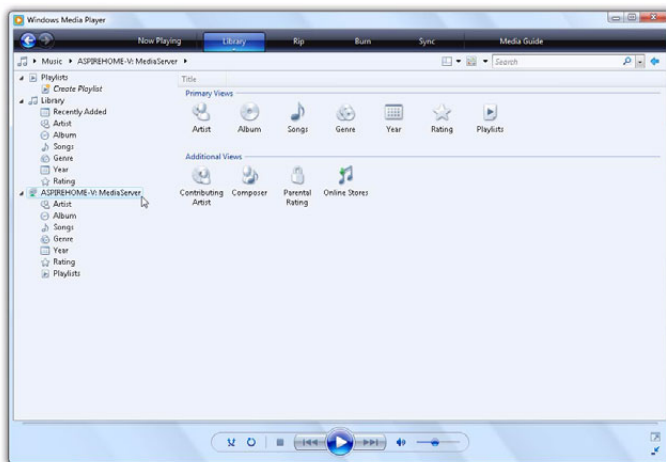

- 5 Browse or search for the item you want to play, then click the **Play** button.



To stream audio in iTunes:

- 1 Make sure that media sharing is enabled. Refer to “Enable media sharing” on page 84 for more information.
- 2 Make sure iTunes Service is enabled. Refer to “Settings for iTunes Server” on page 60 for more information.
- 3 Open the iTunes. The Acer Aspire easyStore H340 appears under Shared on the left of the iTunes window.

Audio files are streamed in iTunes and displayed under the Shared list.

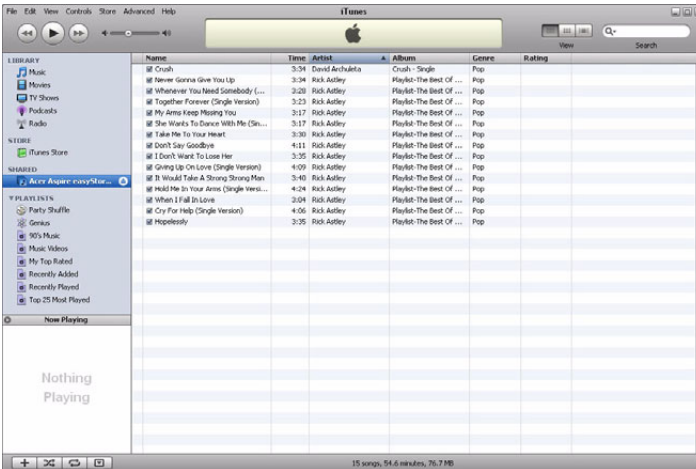

- 4 Browse or search for the item you want to play, then click the **Play** button.



# Using the one-touch USB backup feature

The USB backup button on the front panel allows you to backup data from a USB storage device to the home server. Windows Home Server copies all files into the Publics shared folder first then classifies the files according to media type into their corresponding shared folders, namely Music, Videos, Photos. When Windows Home Server cannot determine file type, the file is automatically stored into the Others folder.



**Important:** Only the front USB port supports backup feature.

To use one-touch USB backup to back up data from a USB storage device:

- 1 Plug the USB device into the front USB port.

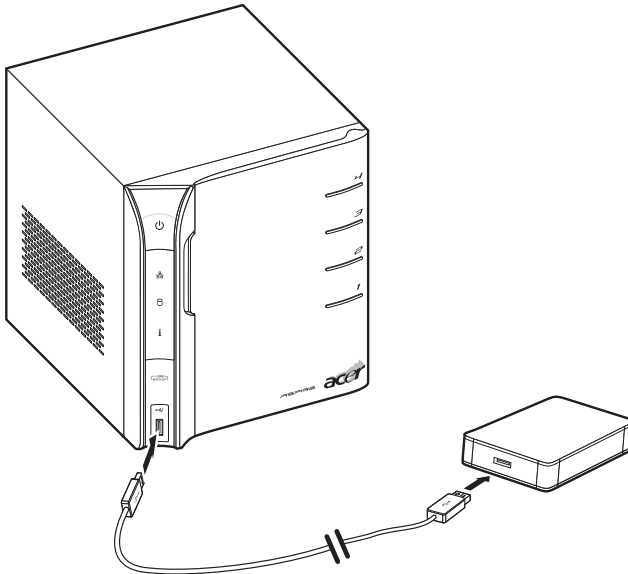

- 2 Press the **USB backup** button. The USB backup indicator blinks blue.

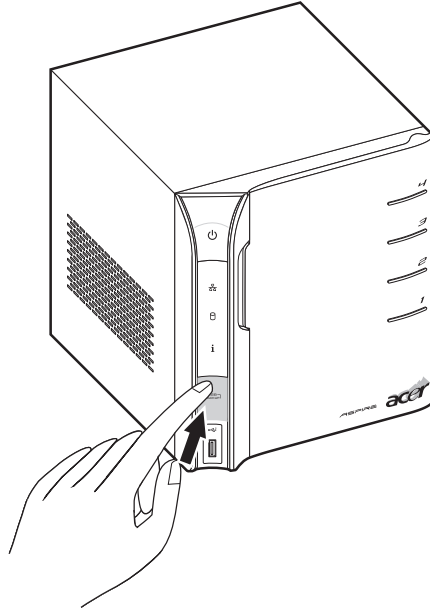

- 3 All files on the USB storage device are copied into the Publics shared folder.



**Note:** During the copy process, Windows Home Server checks the file properties including time, size, and file name to verify whether a file of the same name or exactly the same file exists in the folder. If there is a conflicting file name, the data will be copied but will be assigned a serial number on the file name. If the file of exactly the same properties already exists in the Publics shared folder, the file will be filtered out of from the copy process.

- 4 Afterwards, Windows Home Server automatically copies and classifies the newly copied files according to their file type.
- 5 You can find files of different types in their corresponding shared folders (Music, Videos and Photos). Files other than music, videos and photos are accommodated in the Others folder.
- 6 When the back up process is completed, the USB backup indicator turns solid blue.

# Set up Wake On LAN on the home server

The home server includes a Lights Out client software that allows the home computer to control the power state of the home server and wake up the home server from stand by. The Lights Out Client Service runs in the background. The utility do not have any user interface. You don't have to configure any address. Every time the client computer (that has the Windows Home Server Connector software installed) is started or comes out of standby, a WOL (Wake On LAN) magic packet is sent to the server.

To set up Wake On LAN on the home server:

- 1 Place the Aspire easyStore H340 Software Installation Disc in the optical drive of the home computer. The installation wizard starts.

Or, double-click on the **Acer ClientCD Utility.exe** file to begin installation. The Welcome window appears.



- 2 Click **Lights out**.



**Note:** The Lights Out Client installer checks if the home computer has the Windows Home Server Connector. If no connector is found, the installation is aborted.

- 3 Select a language.



- 4 Click **OK**. The Welcome window appears.

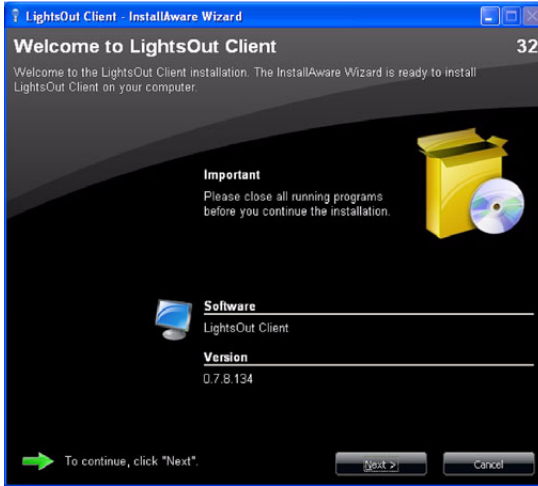

- 5 Click **Next**.

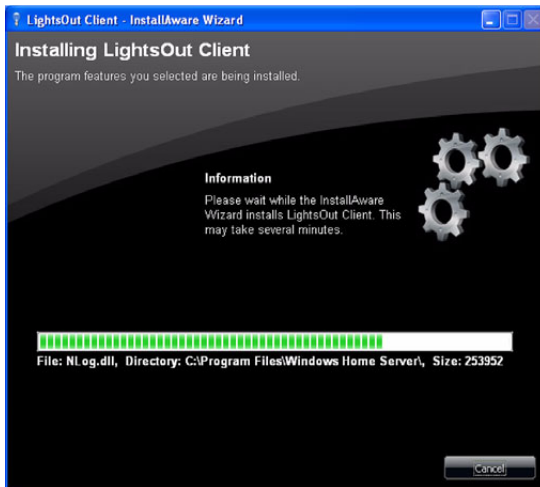

- 6 Click **Finish**.

# Set the home server uptime and down time

You can define times when the home server has to be up and running or define services where the server is never put into sleep mode during an active backup operation to reduce the risk of data loss.



**Note:** When creating an uptime you must enter a start and end time. The uptime end action can be created as a standalone action or in combination with an uptime.

To set the home server uptime and downtime:

- 1 Double-click the **Windows Home Server** icon  in the system tray.
- 2 Log on to the **Windows Home Server Console**.
- 3 Click the **Lights Out** tab.



Home computers are indicated by color blocks in the diagram. When you have more than 6 computers, the colors will be duplicated. The diagrams are created from left to right in the same order as the legend from top to bottom.

#### 4 Click Calendar.

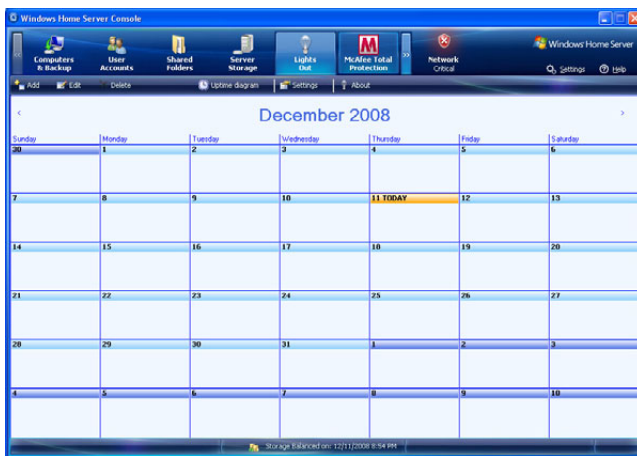

#### 5 Select a day or days in the Calendar, then click Add.

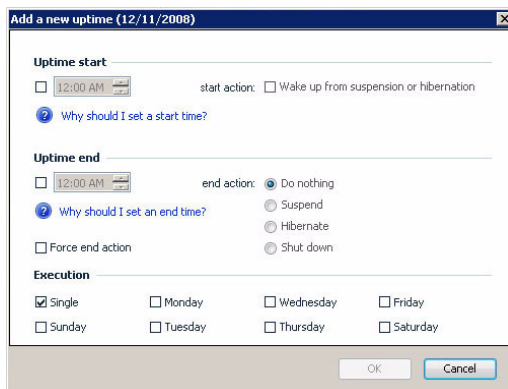

#### 6 Under Uptime start, set a start time to keep the server running.

#### 7 Enable the "Wake up from suspension" option if you want to bring the home server out of standby on the defined time.

#### 8 Under Uptime end, set an end time to disable the server.

#### 9 Select from the following end actions:

- Do nothing - This is not useful for a standalone end action.
- Suspend - Puts your server into suspend mode.
- Shut down - Shuts down and powers off the server.

- 10 Enable the “Force end action” option if you want to immediately disable the server even when client monitoring detects active clients.
- 11 Select a day or days when to execute the command you selected in uptime start and uptime end parameter.
- 12 Click **OK**.



# Monitor server health and performance

Your system includes a Hardware Health and Performance Monitor feature to help you keep a close eye on the system health of the home server. You can view graphical representations of a performance counter for CPU usage, memory usage, and storage usage and view the status of the home server's fans, voltage, and temperature.



**Note:** To start the monitoring service successfully, it is required that you have administrator privileges on the home server.

To monitor the hardware health and performance data of the home server:

- 1 Double-click the **Windows Home Server** icon  in the system tray.
- 2 Log on to the **Windows Home Server Console**.
- 3 Click the **System Information** tab.
- 4 Scroll down to the Hardware Performance and Health Monitor field.

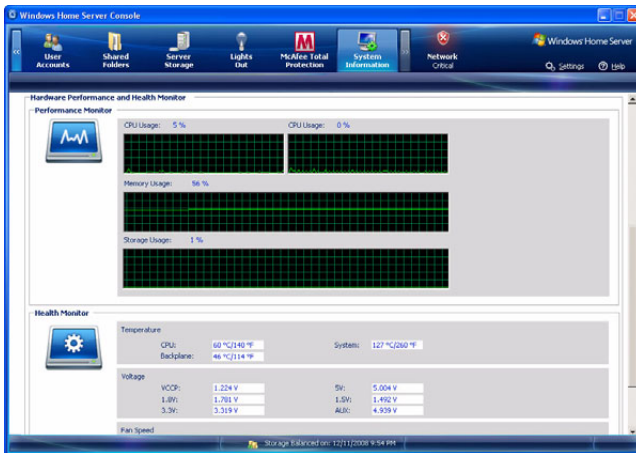

# Set up email alerts

You can set up an automatic email notification to provide alerts in the event of warnings or errors related to temperatures, fan speeds, or hard drive occurred. To validate the email alerting feature, you must also configure SMTP setup.

To set up automatic email notifications:

- 1 Double-click the **Windows Home Server** icon  in the system tray.
- 2 Log on to the **Windows Home Server Console**.
- 3 Click **Settings**.
- 4 In the navigation pane, select **Hardware Health and Performance Monitor**.

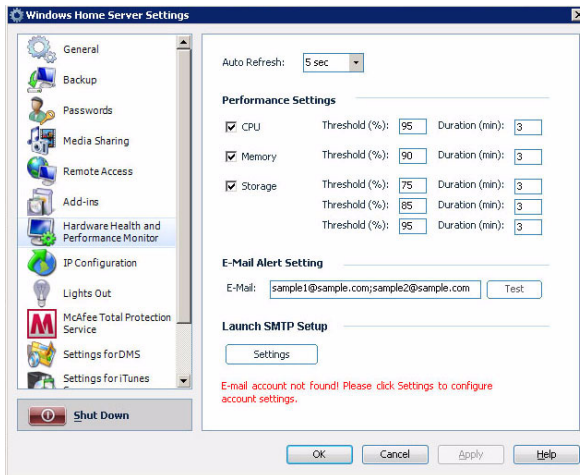

- 5 In the E-Mail Alert Setting, type an email address to which email alerts will be sent. If there are more than one addresses, use a semicolon to separate different addresses.

- 6 Under Launch SMTP Setup, click **Settings**.

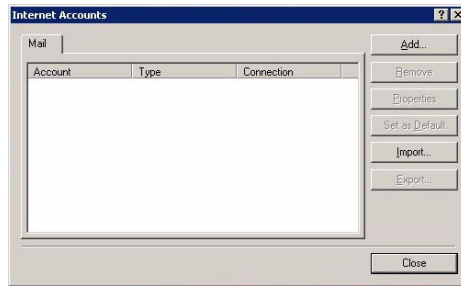

The Internet Accounts dialog box include the following options:

- Remove - Deletes an Internet Mail Account.
  - Properties - Displays the Properties dialog box. This dialog box lets you configure the properties of established connections.
  - Set as Default - Sets an Internet Mail Account as the primary account.
  - Import - Imports your Internet Mail Account settings to an Internet Account (.iaf) file format.
  - Export - Exports an Internet Mail Account settings.
  - Close - Exits the Internet Accounts dialog box.
- 7 Click **Add** to add an Internet connection.



8 Enter your name, then click **Next**.

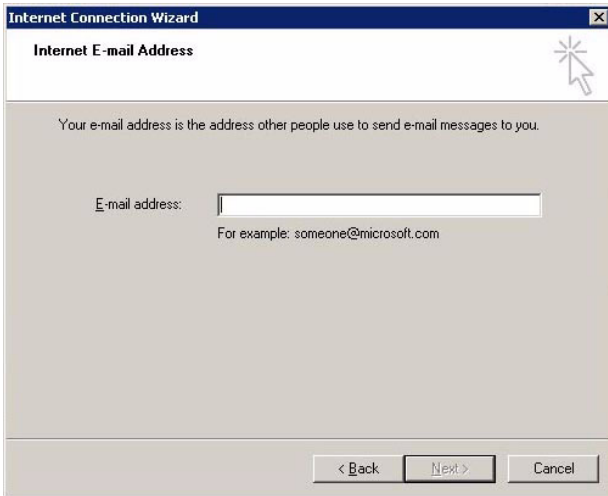

9 Enter your email address, then click **Next**.

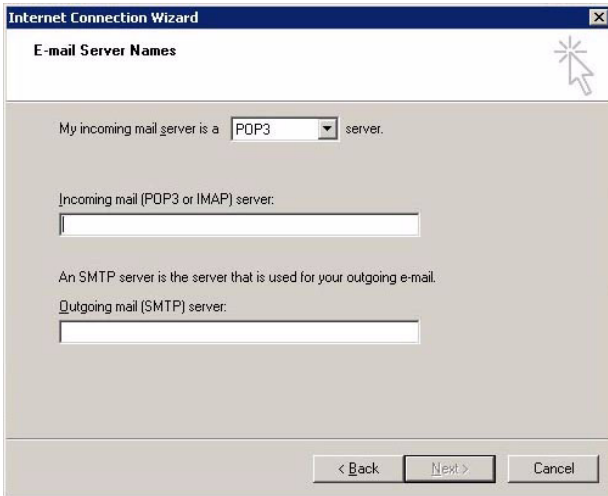

- 10 Enter the SMTP server information, then click **Next**.



**Note:** If you do not know your incoming and outgoing SMTP server name, contact your ISP (Internet service provider).

The screenshot shows a window titled "Internet Connection Wizard" with a sub-header "Internet Mail Logon". The window contains the following elements:

- A close button (X) in the top right corner.
- A text prompt: "Type the account name and password your Internet service provider has given you."
- An "Account name:" label followed by a text input field containing "John Doe".
- A "Password:" label followed by an empty password input field.
- A checked checkbox labeled "Remember password".
- Instructional text: "If your Internet service provider requires you to use Secure Password Authentication (SPA) to access your mail account, select the 'Log On Using Secure Password Authentication (SPA)' check box."
- An unchecked checkbox labeled "Log on using Secure Password Authentication (SPA)".
- Navigation buttons at the bottom: "< Back", "Next >", and "Cancel".

- 11 Enter the account name and password your ISP has given you, then click **Next**.



-----

**Note:** Select the "Log On Using Secure Password Authentication (SPA)" check box if your ISP requires you to use Secure Password Authentication to access your mail account.







- 12 Click **Finish**.
- 13 On the Hardware Health and Performance Monitor page, click **Test** to send testing mails to the email addresses specified in order to verify whether notification can arrive smoothly.
- 14 Click **OK**.

Click **Help** in the Hardware Health and Performance Monitor page for more information.

# Explore the Windows Home Server icon

The Windows Home Server icon notifies you about the health and status of the home server and your home computers. This includes notifications about user account password mismatches, software upgrades, and backup status. The icon also provides quick access to the Windows Home Server Connector software via a right-click menu.

The color of the Windows Home Server icon represents the status of the home server:

Color	Status
	Indicates a healthy network
	Indicates an issue that you must attend soon
	Indicates an issue that you must attend to immediately
	Indicates that a backup is in progress
	Indicates that your home computer cannot contact Windows Home Server

For more information, right-click the Windows Home Server icon, click Help.





# 5 Configuring the hard disk drive

The system supports up to four 3.5-inch hot-swappable SATA hard disk drives.



.....  
**Warning:** The first hard drive, located on the bottom of the HDD bay, is not hot-swappable.

## Adding a hard disk drive



.....  
**Caution:** Hard drives are formatted before they are added to the server storage. Make sure that you back up any important files that are on the hard drive before you add it to server storage. Formatting a hard drive deletes all files on the hard drive.

1 Install the new HDD to the home server.

(1) Open the door of the home server.

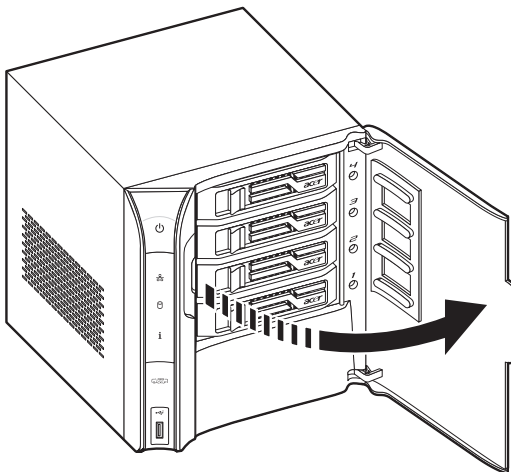

- (2) Remove the HDD carrier by pressing the HDD carrier latch (1).
- (3) Pull the lever (2) and slide the HDD carrier from the chassis (3).

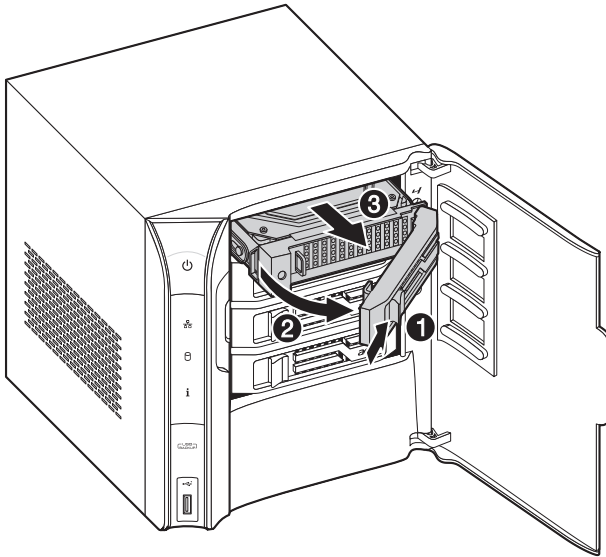

- (4) Insert the new drive into the right side of the carrier aligning the pins into the HDD's mounting holes (1).
- (5) Slightly bend the left side rail and insert the pins into the HDD's mounting holes (2).

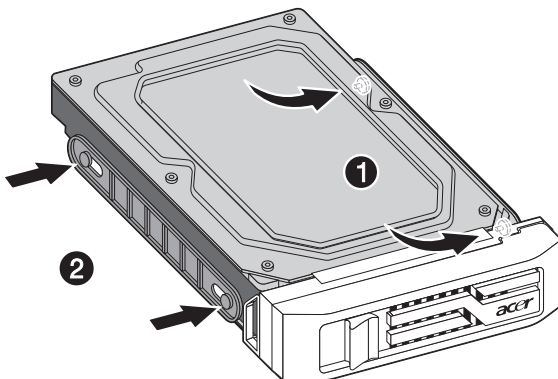

- (6) With the lever still extended, slide the carrier all the way into the drive bay (1). Do not push on the lever until it begins to close by itself.
- (7) Use the lever to push the carrier until it docks into place, then close the lever (2).

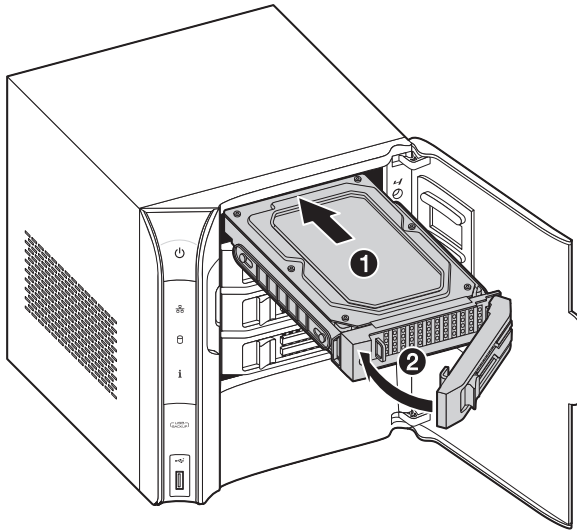

- (8) Close the door of the home server.
- 2 Add the hard drive to the server storage on Windows Home Server Console.
    - (1) Double-click the **Windows Home Server** icon  in the system tray.
    - (2) Log on to the **Windows Home Server Console**.

(3) Click the **Server Storage** tab.

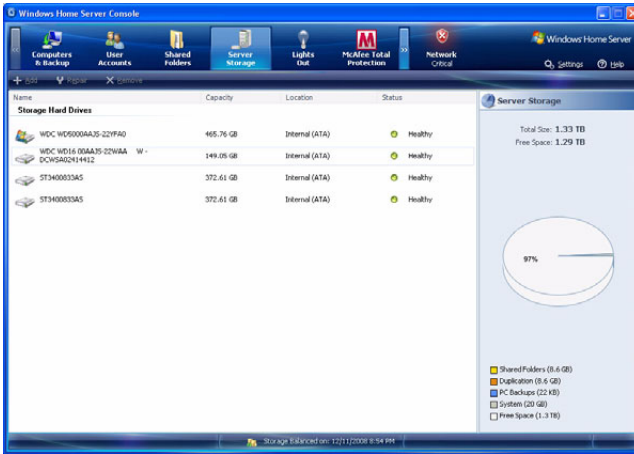

(4) Select the newly installed hard drive (either internal or external), then click **Add** to run the Add a Hard Drive Wizard.

(5) Click **Next**.

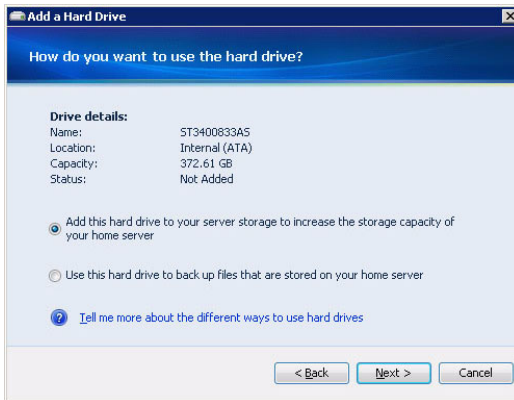

(6) Select from the following options:

- Add this hard drive to your server storage to increase the storage capacity of your home server. This option gives you more space to store home computer backups and more space for your shared folders.

- Use this hard drive to back up files that are stored on your home server. This option allows you to backup all your home server shared folders.
- (7) You can refer to the Windows Home Server Console Help for detailed instructions.



.....

**Important:** When you add a hard drive to your server storage, you commit it to be part of your total server-storage space. Do not disconnect the hard drive to use it for other purposes. If you want to use the hard drive for other purposes, you should first select the hard drive and click **Remove**.

# Removing a hard disk drive



**Caution:** Always remove the hard drive from the Windows Home Server Console before removing an HDD from the home server. You will lose all files on a hard drive if you physically disconnect the HDD from your home server without running the Remove a Hard Drive Wizard and you can no longer find the hard drive in order to connect it again.

- 1 Safely remove hard drive from the Windows Home Server Console.
  - (1) Double-click the **Windows Home Server** icon  in the system tray.
  - (2) Log on to the **Windows Home Server Console**.
  - (3) Click the **Server Storage** tab.

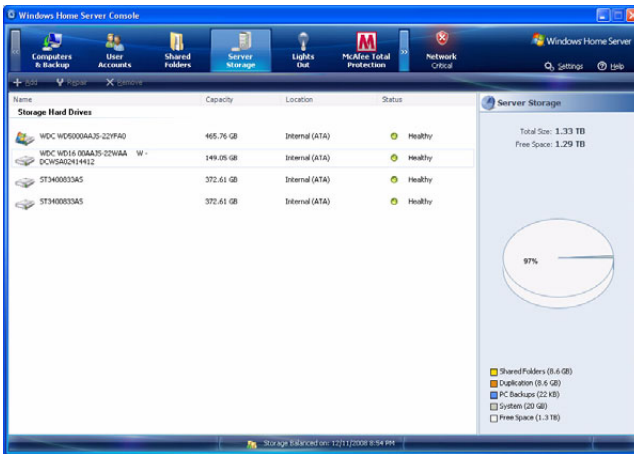

- (4) Select the hard drive you want to remove, then click **Remove** to run the Remove a Hard Drive Wizard.
- (5) Click **Next**.
- (6) Click **Finish**.
- (7) The HDD indicator of the selected drive lights purple.

## 2 Remove the HDD from the home server.



.....  
**Note:** Before removing the HDD, make sure the HDD indicator on the front panel lights purple.

### (1) Open the door of the home server.

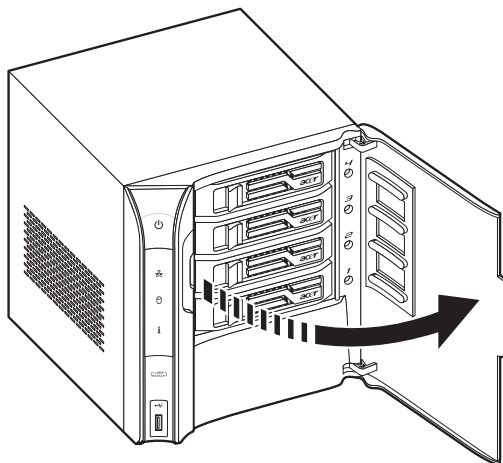

### (2) Press the HDD carrier latch (1).

### (3) Pull the lever (2) and slide the HDD carrier from the chassis (3).

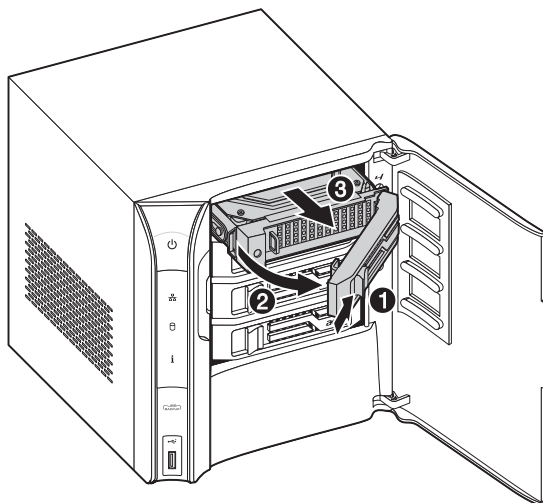

- (4) Close the door of the home server.

## Replacing a failed hard disk drive

- 1 Follow steps 1 and 2 of the "Removing a hard disk drive" section.
- 2 Remove the HDD from the carrier.
  - (1) Gently pry open the left side rail (1, 2), as shown.
  - (2) Remove the drive from the carrier (3).

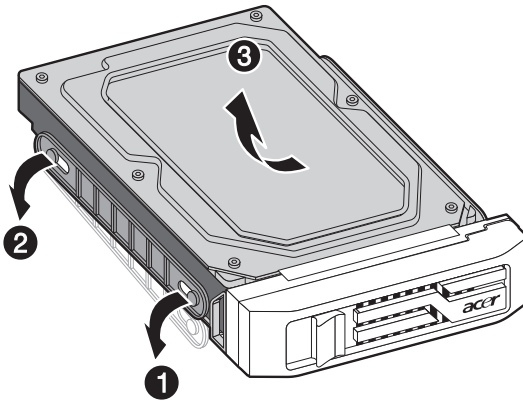

- 3 Install the new HDD into the carrier.
  - (1) Insert the new drive into the right side of the carrier aligning the pins into the HDD's mounting holes (1).



- (2) Slightly bend the left side rail and insert the pins into the HDD's mounting holes (2).

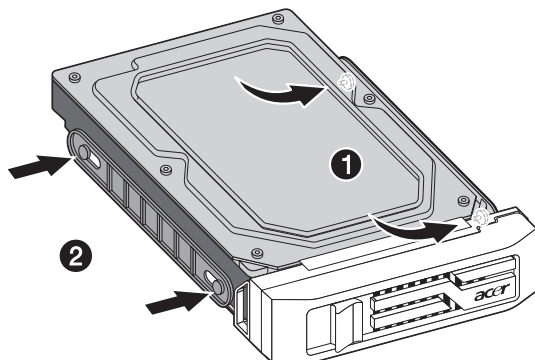

- 4 Install the new HDD to the home server.



# 6 Troubleshooting

This chapter describes a list of possible situations that may arise during the use of your home server.

If you are unable to resolve problems on your own, contact your dealer or local Acer representative for assistance.

## First steps checklist

- AC power available at the wall outlet?
- Are the power supplies plugged in? Check the AC cable(s) on the back of the chassis and at the AC source.
- Are all cables correctly connected and secured?
- Are all peripheral devices installed correctly?
- Are all device drivers properly installed?
- Did you press the system power button on the front panel to turn the system on (power indicator should be lit)?
- Is the system power cord properly connected to the system and plugged into an outlet for 100-127 V or 200-240 V?

# Recovering or restoring the home server

Aspire easyStore H340 includes a Server Recovery DVD that allows you to recover your home server after a system failure (i.e., the operating system is corrupted, the main system hard drive failed). You can also use this disc to restore the home server to its factory default.

In Server Recovery, the home server's system settings and user accounts will be lost. When you select the Factory Reset option, all data on the home server's hard drives will be lost.

To recover the home server:

- 1 Place the Aspire easyStore H340 Server Recovery DVD in the DVD drive of a computer connected to the network.

Or, double-click on the **Acer ServerRecovery Utility.exe** file to begin installation. The Server Recovery window appears.



- 2 Click **Next**.

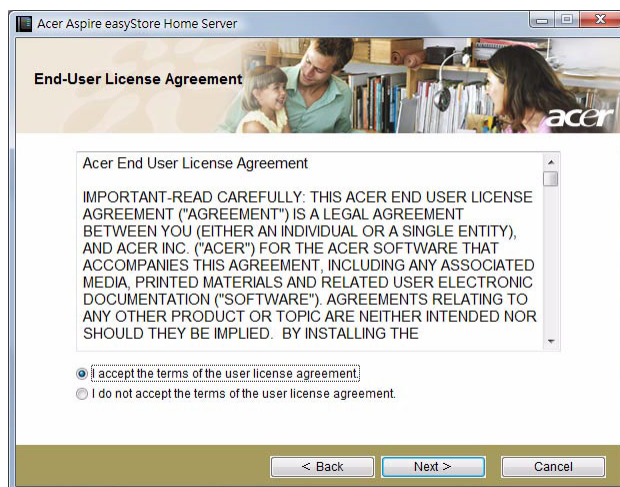

- 3 Read the End-User License Agreement. If you agree with the terms of the agreement, then select the "I accept the terms of the user license agreement" option button.
- 4 Click **Next**.

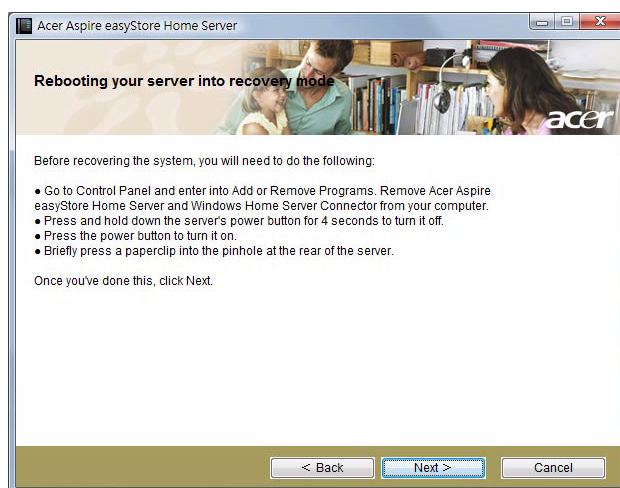

- 5 Uninstall the Acer Aspire easyStore H340 and Windows Home Server Connector from your computer.

- 6 Recover the home server.
  - (1) Hold down the power button for 4 seconds to turn off the home server.
  - (2) Press the power button to turn it on.
  - (3) Turn the system around so that you have access to the back of the unit.
  - (4) Insert the end of an unfolded paperclip into the opening, and then press and hold the recovery/reset button with the paperclip end.
- 7 Click **Next**.

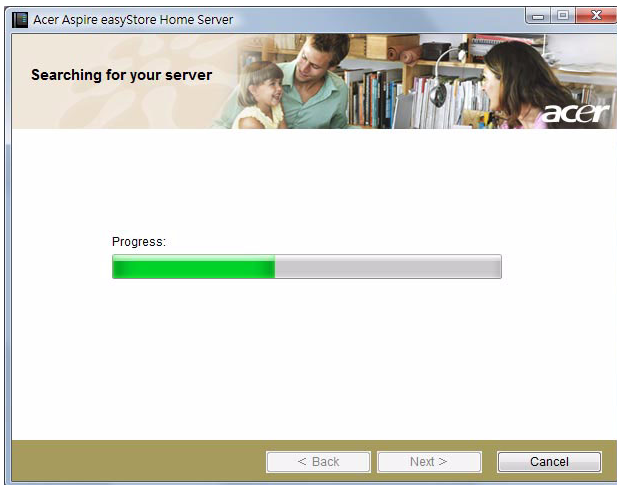

- 8 Select the "Server Recovery: Use this option to recover from a system failure. You will lose your system settings and user accounts. Data recovery will be attempted. (Recommended)" option button.

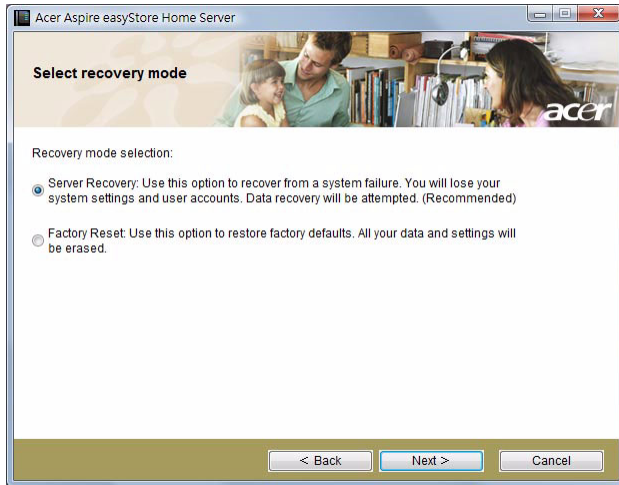

- 9 Click **Next** and follow all onscreen instructions until you finish recovery process.

To restore the home server to factory default setting:

- 1 Place the Server Recovery DVD in the DVD drive of a computer connected to the network.

Or, double-click on the **Acer ServerRecovery Utility.exe** file to begin installation. The Server Recovery window appears.

- 2 Click **Next**.
- 3 Read the End-User License Agreement. If you agree with the terms of the agreement, then select the "I accept the terms of the user license agreement" option button.
- 4 Click **Next**.
- 5 Uninstall the Acer Aspire easyStore H340 and Windows Home Server Connector from your computer.

- 6 Recover or reset the home server:
  - (1) Hold down the power button for 4 seconds to turn off the home server.
  - (2) Press the power button to turn it on.
  - (3) Turn the system around so that you have access to the back of the unit.
  - (4) Insert the end of an unfolded paperclip into the opening, and then press and hold the recovery/reset button with the paperclip end.
- 7 Click **Next**.
- 8 Select the “Factory Reset: Use this option to restore factory defaults. All your data and settings will be erased” option button.

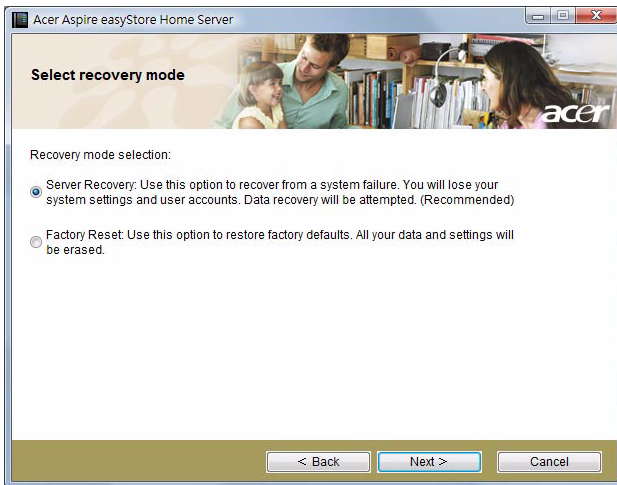

- 9 Click **Next** and follow all onscreen instructions until you finish restore process.



# Restoring a home computer

You can easily restore any of your home computers to a previous point in time with a backup stored on your home server. You can do this by using the PC Recovery Disc. This CD can be used to restore all of the files on your home computer from a backup, including the Windows operating system and applications.

To restore a home computer:



.....  
**Important:** You need the Windows Home Server administrator password to restore a home computer.

- 1 Place the Aspire easyStore H340 PC Recovery Disc in the CD drive of the computer that you want to restore.
- 2 Restart the computer and boot from CD.
- 3 Follow the instructions in the Restore Computer Wizard to restore the hard drives on your home computer.



.....  
**Note:** Your home computer must be connected to the home network with an Ethernet network cable before you begin the restore. Wireless connection is not supported.

When you boot the home computer to the PC Recovery Disc, it lists the NIC (network interface card) and storage devices it has found and it provides an option to load drivers, as shown in the screenshot below. It can also search USB flash or USB floppy drives for driver files and load any found Windows drivers.

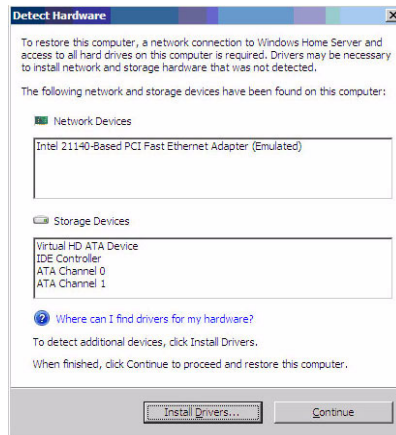

If the drivers did not load or the NIC driver cannot be found during computer recovery, you can perform the options listed below to install the drivers, otherwise the home computer will not be able to connect to the home server to get your backup.

- You can use a Vista-compatible NIC driver, which is fully compatible with computers running Windows Vista or Windows XP. Download and install the Vista-compatible NIC driver from a USB flash or USB floppy drive.
  - On the Detect Hardware dialog box, click "Where can I find drivers for my hardware?" to bring up an online help file for detailed instructions on how to find and load drivers.
  - Go to <http://www.microsoft.com/windows/products/winfamily/windowshomeserver/support.mspx> for more information.
- 4 Every time Windows Home Server backs up a home computer, it saves the drivers for the home computer in the backup that is stored on the home server. When you use the PC Recovery Disc, you will be prompted if the home computer requires drivers for any of your home computers, you can open a backup for that home computer and copy the drivers to a USB flash or USB floppy drive.

# Restoring files from a backup

You can browse and restore lost files from any client computer on your home network that has been backed up with Windows Home Server.

To restore files and folders from a backup:

- 1 Open the **Windows Home Server Console**.
- 2 Click the **Computers & Backup** tab.
- 3 Select a **home computer**, then click **View Backups**.
- 4 Select a **backup**, then click **Open**.
- 5 Select a **volume** to open, then click **Open**.



.....

**Note:** The Opening Backup status window appears while the backup opens. If you are prompted to restart your computer after the virtual volume driver is installed, ignore this message, you do not need to restart your computer.

- 6 Drag the backup files and folders that you want to restore to a folder on your home computer.
- 7 Close the window when you are done copying the files and folders that you want to restore.

# Update your home server with Aspire easyStore H340 Software Update

The Aspire easyStore H340 Software Update is a tool which allows you to easily update the home server BIOS, drivers, and add-in software.

To install the Aspire easyStore H340 Software Update utility:

- 1 Place the Aspire easyStore H340 Software Installation Disc in the optical drive of the home computer. The installation wizard starts.

Or, double-click on the **Acer ClientCD Utility.exe** file to begin installation. The Welcome window appears.



- 2 Click **Software Update**. The Welcome window displays.

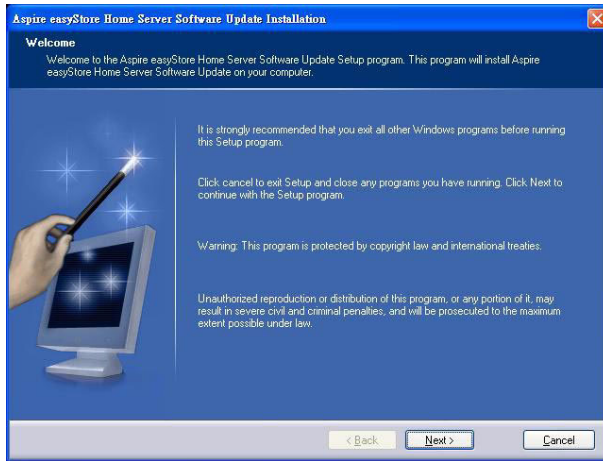

- 3 Click **Next**.

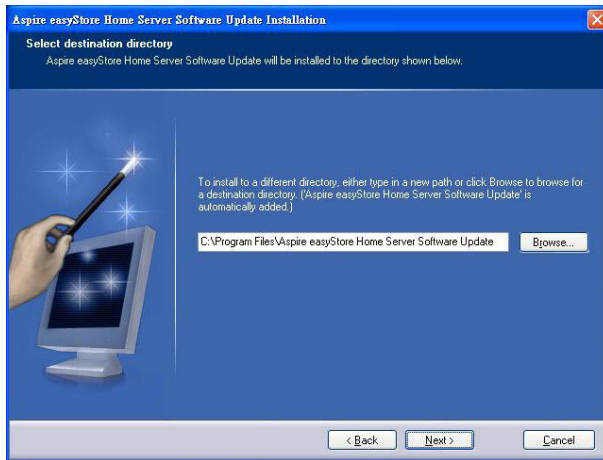

- 4 Select a destination directory, then click **Next**.

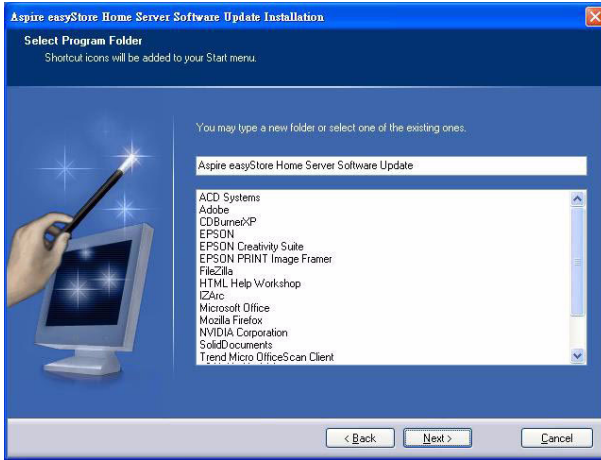

- 5 Select a program folder or enter a new folder, then click **Next**.

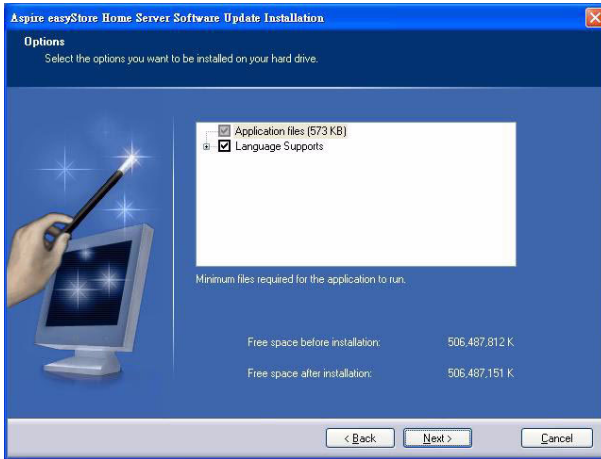

- 6 Select the options you want installed on your hard drive, then click **Next**.

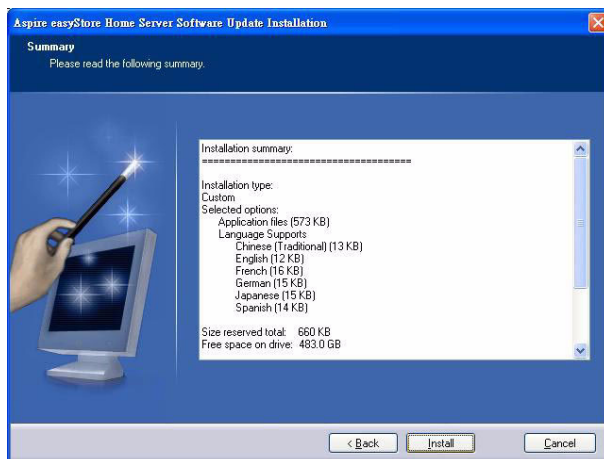

- 7 Click **Install**.

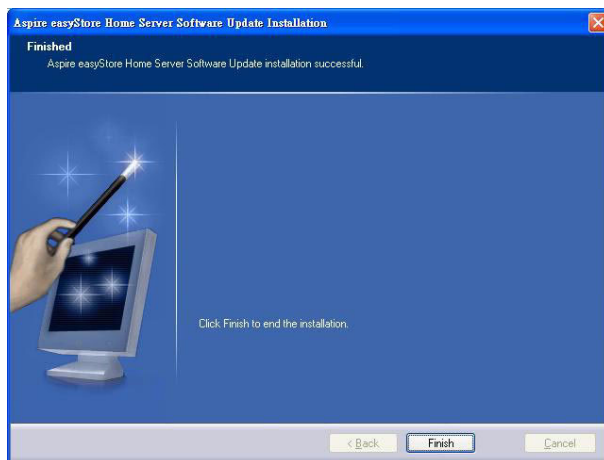

- 8 Click **Finish**.

To update your home server with Software Update utility:

- 1 Make sure the Aspire easyStore H340 Software Update utility is installed on the computer. Refer to previous section for detailed instruction.
- 2 On your computer, click **Start > Programs > Aspire easyStore H340 Software Update > Software Update**.

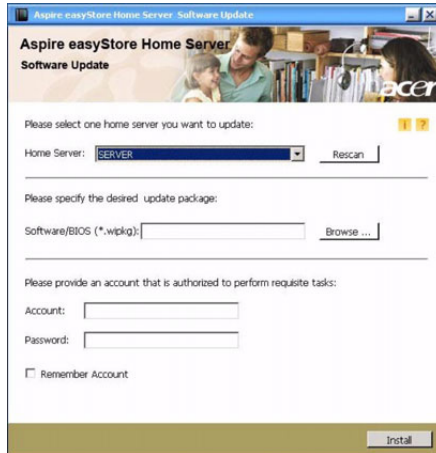

- 3 In the Home Server field, select the home server you want to update. You can click **Rescan** to refresh the list.
- 4 In the Software\BIOS field, click **Browse** to specify the software/BIOS package which will be updated to the home server.
- 5 Enter your name and password.
- 6 Select the "Remember Account" check box if you want the account you entered be shown next time you perform software update.
- 7 Click **Install** and follow onscreen instructions to complete updates.



# Specific problems and corrective actions

The following contains specific problems that may arise during the use of your server. Possible solutions are listed for each problem.

Power indicator does not light.

- Make sure the power button on the front panel is turned on.
- Make sure the power cord is connected correctly.
- Make sure that the wall outlet has power. Test it by plugging another device.

HDD status indicator does not light.

Make sure the hard drive is compatible.

If the drives are pre-installed, contact technical support.

Home server cannot connect to a network and the network indicator on the front panel does not light.

- Make sure the network cable is securely attached to the correct connector at the system rear panel.
- Try a different network cable.
- Make sure the broadband router has power.

Home computer cannot connect to the home server

- Make sure the power button on the front panel is turned on.
- Make sure the network indicator on the front panel lights blue.
- Make sure the broadband router has power.
- Make sure a firewall is not blocking the connection. Refer to the Windows Home Server Console Help for more information.
- Shutdown and restart your home server.
- Reset the home server.

To soft reset the home server:

- (1) Launch **Windows Home Server Console**.
- (2) Click **Options**.

- (3) Select "Reset the Windows Home Server Console" from the drop-down menu.
- (4) Click **OK**.

### Backup service is not running

If you see the "If backup service is not running, please restart the console." error message, try resetting the home server.

- 1 Launch **Windows Home Server Console**.
- 2 Click **Options**.
- 3 Select "Reset the Windows Home Server Console" from the drop-down menu.
- 4 Click **OK**.

### How do I save the Windows Home Server backup database

For detailed instructions on how to copy the backup database from your Windows Home Server, go to <http://www.microsoft.com/windows/products/winfamily/windowshomeserver/support.msp>

### Web browser cannot display the Aspire easyStore H340 Remote Access page when accessing through URL

- Make sure the Web site connectivity in Settings is turned on.
- Make sure JavaScript is enabled on your browser.

To enable JavaScript in Internet Explorer 7:

- (1) From the Internet Explorer menu, go to **Tools**, then select Internet Options.
- (2) Choose the **Security** tab, then click **Custom Level**.
- (3) Scroll down to Active Scripting, then select **Enable**.
- (4) Click **OK**.

## Can't connect to some computers on the Aspire easyStore H340 Remote Access page

Make sure the home computer is configured to allow remote desktop connection.

To configure computers that are running Windows XP:

- 1 Log on to the computer with a user account that has administrator privileges.
- 2 Click **Start**, right-click **My Computer**, then click **Properties**.
- 3 On the System Properties page, click the **Remote** tab.
- 4 Make sure that the "Allow users to connect remotely to this computer" check box is selected.
- 5 Click **Select Remote Users**. User accounts with administrator privileges are automatically allowed to connect. If you want to allow additional user accounts to remotely access this computer, click **Add** to enter those user accounts.
- 6 If you use Windows Firewall, open **Control Panel**, and then double-click **Windows Firewall**. Verify that Windows Firewall is on. Click the **Exceptions** tab, and then verify that **Remote Desktop** is selected.
- 7 Restart your computer.

To configure computers that are running Windows Vista:

- 1 Log on to the computer with a user account that has administrator privileges.
- 2 Click **Start**, right-click **Computer**, then click **Properties**.
- 3 Click **Remote settings**, click **Continue**.
- 4 Make sure that the "Allow connections from computers running any version of Remote Desktop (less secure)" check box is selected.



-----

**Important:** If you select Allow connections only from computers running Remote Desktop with Network Level Authentication (more secure), you cannot connect to this computer via Windows Home Server Remote Access, and the connection status for this computer is Disabled.

- 5 Click **Select Users**. User accounts with administrator privileges are automatically allowed to connect. If you want to allow additional user accounts to remotely access this computer, click Add to enter those user accounts.
- 6 If you use Windows Firewall, open **Control Panel**, then click **Security**. Click **Windows Firewall**. Verify that Windows Firewall is on. Click **Change Settings**, and then click **Continue**. Click the **Exceptions** tab, then verify that Remote Desktop is selected.
- 7 Restart your computer.

### I forgot the Windows Home Server password

If you don't remember the password, you must reset the home server. Refer to "Recovering or restoring the home server" on page 118 for more information.

## Free Manuals Download Website

<http://myh66.com>

<http://usermanuals.us>

<http://www.somanuals.com>

<http://www.4manuals.cc>

<http://www.manual-lib.com>

<http://www.404manual.com>

<http://www.luxmanual.com>

<http://aubethermostatmanual.com>

Golf course search by state

<http://golfingnear.com>

Email search by domain

<http://emailbydomain.com>

Auto manuals search

<http://auto.somanuals.com>

TV manuals search

<http://tv.somanuals.com>